

HSCI2013

Proceedings of the
10th International Conference on

Hands-on Science

Educating for Science and through Science

1st-5th July 2013

Pavol Jozef Šafárik University
Košice, Slovakia



The Hands-on Science Network



HSCI2013
Proceedings of the
10th International Conference on Hands-on Science
Educating for Science and through Science
1st-5th July 2013
Pavol Jozef Šafárik University, Košice, Slovakia
ISBN 978-989-98032-2-0
Online available on <http://www.hsci.info>

Chair:

Manuel Filipe Pereira da Cunha Martins Costa (Portugal)

Chair of Local Organizing Committee:

Marián Kireš (Slovakia)

International Advisory Committee:

Abhay Kothari (India)

Amit Garg (India)

Ann Torsted (Denmark)

António Carlos Pavão (Brazil)

Armando Dias Tavares Jr. (Brazil)

Clementina Timus (Romania)

Daniel Gil Pérez (Spain)

George Kalkanis (Greece)

Erik Johansson (Sweden)

Eva Trnova (Czech Republic)

Fernando Ribeiro (Portugal)

Francisco Sousa (Portugal)

Francisco Esquembre (Spain)

Hai-Ning Cui (China)

Horst Bannwarth (Germany)

Iryna Berezovska, (Ukraine)

Jesus Blanco (Spain)

Joaquim Carneiro (Portugal)

Jose Benito Vazquez-Dorrio (Spain)

Joseph Trna (Czech Republic)

Maria de Jesus Gomes (Portugal)

Maria Inês Nogueira (Brazil)

Maria Odete Valente (Portugal)

Marian Kires (Slovakia)

Marisa Michelini (Italy)

Maria Teresa Malheiro (Portugal)

Mario Belloni, (USA)

Maxim Tomilin (Russia)

Mehmet Erdogan (Turkey)

Mikiya Muramatsu, (Brasil)

Mourad Zghal (Tunisia)

Mustafa Erol (Turkey)

Nilgün Erentay (Turkey)

Panagiotis Michaelides (Greece)

Paulo Idalino Balça Varela (Portugal)

Pedro Membiela Iglesias (Spain)

Radu Chisleag (Romania)

Roger Ferlet (France)

Sasa Divjak (Slovenia)

Sonia Seixas (Portugal)

Suzanne Gatt (Malta)

Walburga Bannwarth-Pabst (Germany)

Local Organizing Committee:

Dušan Šveda

Zuzana Ješková

Katarína Kimáková

Mária Ganajová

Stanislav Lukáč

Lubomír Šnajder

Jozef Hanč

Ľudmila Onderová

Ján Guniš

Slávka Blichová

Radoslav Kalakay

Rastislav Adámek

Stela Csachová

Josef Dobos

HSCI2013
Proceedings of the
10th International Conference on Hands-on Science
Educating for Science and through Science
1st-5th July 2013
Pavol Jozef Šafárik University, Košice, Slovakia
ISBN 978-989-98032-2-0
Online available on <http://www.hsci.info>

Edited by

Manuel Filipe Pereira da Cunha Martins Costa, University of Minho, Portugal

José Benito Vázquez Dorrío, University of Vigo, Spain

Marián Kireš, Pavol Jozef Šafárik University, Košice, Slovakia

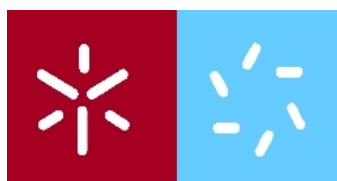

Universidade do Minho
Escola de Ciências

Universidade de Vigo



Pavol Jozef Šafárik University in Košice
Faculty of Science

The Hands-on Science Network



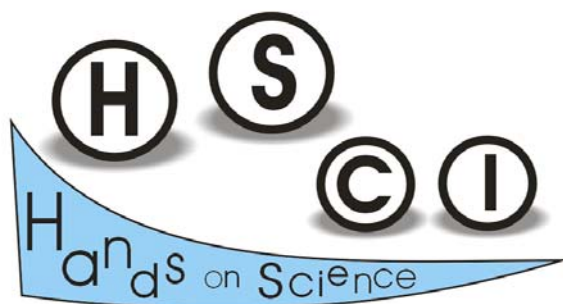

Copyright © 2013 H-Sci

ISBN 978-989-98032-2-0

Printed by: Equilibria, s.r.o., Košice, Slovakia

Number of copies: 180

First printing: July 2013

Distributed worldwide by *The Hands-on Science Network* - contact@hsci.info

Full text available online at <http://www.hsci.info>

The papers published in this book compose the Proceedings of the 10th International Conference on Hands-on Science. Papers were selected by the Conference Committees to be presented in oral or poster format, and were subject to review by the editors and program committee. They are exclusive responsibility of the authors and are published herein as submitted, in interest of timely dissemination.

Please use the following format to cite material from this book:

Author(s). Title of Paper. Proceedings of the 10th International Conference on Hands-on Science. Costa MF, Dorrio BV, Kireš M (Eds.); 2013, 1-5 July; Pavol Jozef Šafárik University, Košice, Slovakia. 2013. Page numbers.

The authors of this book, the Hands-on Science Network, the organizers and the sponsors of the HSCI2013 Conference, none of them, accept any responsibility for any use of the information contained in this book.

All rights reserved.

Permission to use is granted if appropriate reference to this source is made, the use is for educational purposes and no fees or other income is charged.

The Organizers of the 10th International Conference on Hands-on Science acknowledge the sponsorship cooperation and support of these sponsorships and collaborations:

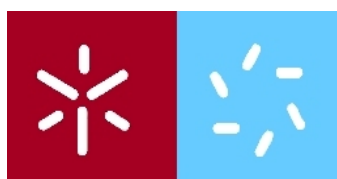

Universidade do Minho
Escola de Ciências

Universidade de Vigo



Pavol Jozef Šafárik University in Košice
Faculty of Science



PD COMP, distribútor produktov CMA



Vernier



PMS Delta s.r.o.

Autorizovaný dovoz, predaj a poradenstvo Vernier



SLOVAK RESEARCH
AND DEVELOPMENT
AGENCY

LPP-0223-09 Science on Stage Slovakia

SLOVENSKÁ
SPORITELŇA



Občianske združenie
PRIRODOVEDEC



KOŠICE2013
EUROPEAN CAPITAL OF CULTURE



SCIENCE in SCHOOL

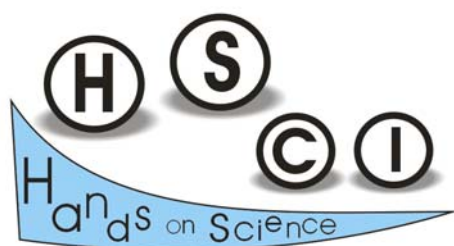

Education and Culture
Lifelong learning programme
COMENIUS

Foreword

Educating for Science and through Science

Back in 2003 the Hands-on Science Network was established as a Socrates/Comenius 3 project supported by the European Commission. Our aim was to contribute to the generalization innovation and improvement of Science & Technology Education at basic vocational training and secondary schools by hands-on experimental investigative practice in the classroom ... *bringing hands-on active learning of Science into the classroom and into the soul and spirit of the School ...*

With a broad open understanding of the meaning and importance of Science to the development of our societies, each individual and of the humankind, soon we extended our intervention embracing all levels of formal informal and non-formal education from the kindergarten to adult and lifelong learning and actively enrolling teachers educators researchers and all interested and in some way involved with Science Education in the widest range of fields of science, and also transversally in engineering and technology, from all over the world.

Open to all pedagogic approaches that may contribute to the effective implementation of a sound widespread scientific literacy and effective Science Education in our schools and society *at large*, we advise the employment of open and flexible strategies to lead our students and fellow citizens to learn about Science in a committed active and investigative hands-on experiments based way, employing the experimental method behind the search for scientific knowledge,... feeling the thrill of discovering and understanding our world.

In an informal friendly and open minded atmosphere, the participants in our annual conferences find a suitable ground to share their experiences concerns and doubts getting concrete solutions to practical teaching problems and a sound positive peer mutual support.

As Chair of the conference and president of the International Association Hands-on Science Network it is my great pleasure and honour to welcome you all to the 10th edition of our annual conference!

I would like to thank Assoc. Prof. Marián Kireš and his team of the Pavol Jozef Šafárik University in Košice, for this excellent organization, and to all authors and participants to the *10th International Conference on Hands-on Science - Educating for Science and through Science* giving all a warm welcome to Košice, wishing you a wonderful stay at the European Capital of Culture' 2013!

Vila Verde, June 16, 2013.

Manuel Filipe Pereira da Cunha Martins Costa
HSCI'2013 Chair

FOREWORD

INQUIRY BASED SCIENCE EDUCATION	1
THE USE OF ICT IN THE FRAMEWORK OF INQUIRY BASED SCIENCE EDUCATION (IBSE)	
Ton Ellermeijer	3
THE PHYSICS OF THE DRIVEN SPINNING TOP	
Ioan Grosu	7
GAMES, GAMES AND GAMES	
Asli Tasci, Ebru Aghasi	9
IPPOG - BRINGING PARTICLE PHYSICS INTO CLASSROOMS	
Ivan Melo	10
CONNECTING CLASSROOMS TO THE MILKY WAY	
Roger Ferler	15
THE CITY BRIDGES PROJECT: CONNECTING PEOPLE, MERGING SCIENCES	
Alexander Kazachkov, Marián Kireš, Abraham Salinas Castellanos	17
TEACHING RENEWABLE ENERGY SOURCES BY INQUIRED BASED METHODS	
Elena Vladescu	20
TEACHING MATHEMATICS THROUGH IBSE METHODS	
Lucian Constantin Vladescu	24
INQUIRY BASED SCIENCE EDUCATION – APPLICATION IN CHEMISTRY	
Hana Čtrnáctová, Monika Petriláková, Veronika Zámečnicková	27
HANDS-ON SCIENCE COURSE FOR UPPER PRIMARY AND LOWER SECONDARY SCHOOLS IN POLAND – A CHALLENGE FOR USING IBSE METHODOLOGY IN DEVELOPING PRACTICAL AND EXPLORING SKILLS	
Bożena Karawajczyk, Marek Kwiatkowski	32
BELIEFS OF TEACHERS OF MATHEMATICS ABOUT TEACHING IN A CONSTRUCTIVIST WAY	
Veronika Hubeňáková, Dušan Šveda	36
CYBERNETICS FROM THE POINT OF VIEW OF THE HANDS-ON PRINCIPLE	
Max Igor Bazovsky	41
SUMMER CAMPS SCHOLA LUDUS: EXPERIMENTÁREŇ	
Viera Haverlíková	46
KNOWLEDGE THROUGH SCIENCE AND ART	
Stefureac Crina	49
A STUDY OF ELEMENTARY STUDENTS’ MODELING ABILITY AND LEARNING TRANSFER	
Jen-Chin Lin, Chien-Liang Lin, Fu Yi Shieh	62
EXPERIENCE WITH THE IMPLEMENTATION OF INQUIRY-BASED ACTIVITIES ENHANCED BY DIGITAL TECHNOLOGIES AT ONE OF THE SLOVAK GRAMMAR SCHOOLS	
Veronika Timková, Zuzana Ješková, Mária Horváthová	67
STUDYING SCIENCE WITH MILK CANDY MAKING	
William Stebniki Tabora	73
HOW ATMOSPHERIC PRESSURE CAN LIFT AN ADULT- HANDS-ON EXPERIMENTS BY USING SYRINGE-SYSTEM	
C. H. Chou, M. S. Yang	79
INVESTIGATING PROPERTIES OF LIGHT IN THE FRAME OF LOWER AND UPPER SECONDARY EDUCATION	
Martin Hruška, Stanislav Holec, Jana Raganová	83
SCHOOL PHYSICS EXPERIMENTS FROM THE FIELD OF NUCLEAR PHYSICS	
Peter Zilavy	87
CREATIVITY AND MOTIVATION IN PHYSICS EDUCATION	
Marcela Chovancová	92
HOME EXPERIMENTS OF PUPILS AND STUDENTS - A WAY TO INCREASE THE INTEREST OF YOUNG PEOPLE IN PHYSICS, ENGINEERING AND SCIENCE	
I. Baník, M. Chovancová, G. Pavlendová	96
IMPLICATIONS FOR INSTRUCTION IN INCLINED PLANE HANDS-ON EXPERIMENT	
Yun-Ju Chiu, Feng-Yi Chen	102

CLASSIFICATION AND MEASUREMENT AS A TOOL FOR INQUIRY-BASED APPROACH IN SCIENCE EDUCATION	
Mária Orolínová	106
LEARNING MATERIALS SCIENCE AND TECHNOLOGY FROM HANDS-ON ACTIVITIES	
Carmen. Pérez, Antonio Collazo, Benito.V. Dorrío	110
INVESTIGATE THE SHADOWS OF OBJECTS: A PEDAGOGICAL INTERVENTION PROJECT WITH PRIMARY SCHOOL CHILDREN	
Silvana Noversa, Cátia Abreu, Paulo Varela, Manuel Filipe Costa	115
ANALYSIS OF THE PROCESS OF EXPLORING A PHYSICS ACTIVITY WITH PRE-SCHOOL CHILDREN: THE BALLOON ROCKET	
Paulo Varela Rita Pereira, Cristina Silva, Marta Fernandes, Manuel Filipe Costa	121
REGULATION OF GENE EXPRESSION – USING GENE REPORTERS LACZ AND MCHERRY TO ASSESS THE RESPONSE OF THE LACTOSE OPERON PROMOTER TO CATABOLITE REPRESSION AND POSITIVE INDUCTION	
Catia Soares, Sofia Camarinha, Susana Pereira	126
EXPERIENCE IN USING INQUIRY-BASED METHOD IN CHEMISTRY TEACHING	
Mária Ganajová, Milena Kristofová	131
PROJECT ESTABLISH - CHEMISTRY AND BIOLOGY	
Věra Čížková, Hana Čtrnáctová, Mária Ganajová, Katarína Kimáková, Petr Šmejkal	135
PHENOMENOLOGY IN SCIENCE EDUCATION	
F. Caglin Akillioglu	141
A VIEW OF PROBLEMATIC OF FISHERIES AND AQUACULTURE IN EUROPE	
Sonia Borges Seixas	142
OVERVIEW OF THE IMPACT OF IBSE TRAINING COURSES ON LEARNING STEM IN PRIMARY AND SECONDARY SCHOOLS	
Luminita Florentina Chicinas, Nicolae Micescu	142
SCIENCE ON STAGE EUROPE	
David Featonby	143
SCIENCE WITH SENSORS IN PRIMARY SCHOOLS	
Ewa Kedzierska, Ton Ellermeijer	143
EXPLORING MARINE ECOSYSTEMS WITH ELEMENTARY STUDENTS: A SUCCESSFUL JOURNEY	
Cláudia Faria, Raquel Gaspar, Cátia Santos	143
INQUIRY-BASED LEARNING FOCUSED ON WATER FREEZING	
Marek Balážovič, Boris Tomášik	144
ALTERNATIVE PUPIL 'S CONCEPTIONS ABOUT PHOTOSYNTHESIS AND PLANT RESPIRATION BY PUPILS OF 6TH GRADE OF LOWER SECONDARY SCHOOL	
Katerina Svandova	144
SCIENTIFIC RESEARCH PROJECTS IN VOCATIONAL TRAINING SCHOOLS	
Zita Esteves, Manuel F. M. Costa	145
<hr/>	
POPULARIZATION OF SCIENCE IN SOCIETY	147
<hr/>	
A SCIENCE ACTIVITY GUIDED BY CHILDREN AT PRE-SCHOOL LEVEL: FROM A STRING TO A PENDULUM	
Maria de Fátima Sá Machado, Marta Marques, Paulo Machado, Manuel F. M. Costa, Mário Almeida	149
PHYSICS OUTREACH AT THE UNIVERSITY OF RZESZOW	
Malgorzata Pociask-Bialy, Iryna Berezovska, Krzysztof Golec-Biernat	154
CORRESPONDENCE MATHEMATICAL SEMINARS AS A FORM OF INCREASING OF KNOWLEDGE POTENTIAL	
Róbert Hajduk	158
ONE EXAMPLE ON COMBINATORICS	
František Mošna	162
INITIATING THE SCIENTIFIC METHOD, INITIATING YOUNG RESEARCHERS	
Josep M. Fernández-Novell, Carme Zaragoza Domènech	164
PRACTICAL ACTIVITIES ON CHEMISTRY FOR YOUNG STUDENTS	
Josep M. Fernández-Novell, Carme Zaragoza Domènech	169

MASTERCLASSES AND INFORMAL EDUCATION IN SLOVAKIA Júlia Hlaváčová, Marek Bombara, Alexander Dirner, Mikuláš Gintner, Ivan Melo, Boris Tomášik, Pavol Bartoš, František Franko	175
10 TH INTERNATIONAL CONFERENCE ON HANDS-ON SCIENCE 1 - 5 JULY 2013 KOŠICE, SLOVAKIA SPIE Scholarship; benefits and responsibility Clementina Timus	181
THE ROLE OF INQUIRY SCIENCE LAB WITHIN SCIENCE CENTRE Marián Kireš, Mária Nováková	185
NABOJ - INTERNATIONAL MATHEMATICAL COMPETITION FOR HIGH SCHOOL STUDENTS Róbert Hajduk	188
AN ANNUAL HANDS-ON SCIENCE COMPETITION Salvador Rodriguez, Raquel Vergara, Benito V. Dorrió	190
DEVELOPMENT OF POSITIVE ATTITUDES TOWARDS SCIENCE AT THE CHILDREN SUMMER CAMP Jana Raganová, Martin Hruška, Mária Beniačiková, Katarína Krišková	193
POPULARISATION OF CHEMISTRY AMONG THE INHABITANTS OF GDAŃSK REGION Małgorzata Czaja, Bożena Karawajczyk, Marek Kwiatkowski	198
STATISTICAL ANALYSIS ON THREE HANDS-ON SCIENCE NATIONAL SCIENCE FAIRS IN PORTUGAL Zita Esteves, Manuel F. M. Costa	200
A COUPLE OF PHYSICS TEACHING IDEAS Eudmila Onderová, Jozef Ondera	205
“KATTAN SCIENCE SNACKS”: SMALL EDUCATIONAL SCIENCE EXPERIMENTS TO POPULARIZE SCIENCE AMONG THE PALESTINIAN SOCIETY Bisan KM Battrawi	210
BRINGING BACK OLD PHYSICS & CHEMISTRY INSTRUMENTS TO LIFE: FROM SECONDARY SCHOOLS TO THE GENERAL PUBLIC João Oliveira, Isabel Malaquias	211
FIGHTING SCIENTIFIC ILLITERACY IN PORTUGAL FROM MID XVIII CENTURY TO MID XX CENTURY: A FEW MEANINGFUL ATTEMPTS TO SPREAD SCIENTIFIC KNOWLEDGE OUTSIDE THE PUBLIC SCHOOL Maria Teresa S.R. Gomes, João A.B.P. Oliveira	212
THE PUBLIC COMMUNICATION OF SCIENCE IN GRADUATE PROGRAMS IN PUBLIC HEALTH IN BRAZIL: A PERSPECTIVE OF COORDINATORS Carlos Antonio Teixeira, Paulo Rogério Gallo	212
INQUIRY ACTIVITIES IN STEEL PARK Mária Nováková, Marián Kireš	213
ENGAGING PARENTS INVOLVED IN THEIR CHILDREN'S LEARNING THROUGH HANDS-ON SCIENCE ACTIVITIES Yi-Ting Cheng, Huey-Por Chang, Wen-Yu Chang	213
BIOCIENTISTAS DE PALMO E MEIO - HANDS-ON SCIENCE FOR PRE-SCHOOLERS AT THE DEPARTMENT OF BIOLOGY OF UNIVERSITY OF MINHO Cristina Almeida Aguiar, Maria Judite Almeida, Maria Teresa Almeida, Andreia Gomes, Sandra Paiva	214
PRE-SERVICE AND IN-SERVICE SCIENCE TEACHER TRAINING	215
SCIENCE TEACHER TRAINING AT THE DEPARTMENT OF PHYSICS EDUCATION, MFF UK IN PRAGUE Dana Mandíková, Jitka Houfková, Zdeněk Drozd	217
DRAMA-MANTLE OF THE EXPERT : CREATING CONTEXTS FOR TEACHING INTEGRATIVE INQUIRY BASED ELEMENTARY SCIENCE Samar Darwish Kirresh	221
APPLICATION OF THE FLIPPED CLASSROOM MODEL IN SCIENCE AND MATH EDUCATION IN SLOVAKIA Jozef Hanč	229
MOLECULAR BIOLOGY AND GENETICS - ONE OF THE OVERLOOKED THEMES IN HIGH SCHOOL PRACTICAL BIOLOGY COURSES IN CZECH REPUBLIC Vanda Janštová, Lukáš Falteisek	235

THE ROLES OF CARTOONS AND COMICS IN SCIENCE EDUCATION Eva Trnova, Josef Trna, Vaclav Vacek	240
THE ROLES OF DEMONSTRATION EXPERIMENTS IN SCIENCE EDUCATION Eva Trnova, Josef Trna, Petr Novak	244
SCIENCE TOYS AND INTERACTIVE EXHIBITS IN CHEMISTRY TEACHERS' EDUCATION Ján Reguli	250
TEACHER PREPARATION FOR INQUIRY BASED BIOLOGY EDUCATION AT P. J. ŠAFÁRIK UNIVERSITY Katarína Kimáková, Andrea Lešková	254
A BIOINORGANIC/COORDINATION CHEMISTRY INTEGRATIVE EXPERIMENTAL APPROACH: REVERSIBILITY OF THE ACID HYDROLYSIS OF A CR-S BOND Teresa M. Santos, Júlio Pedrosa de Jesus	258
BIOCHAR HANDS-ON EDUCATION Tomáš Milěř, Jan Hollan, Jindřiška Svobodová	263
FACTORS INFLUENCING ATTITUDE TOWARDS DISSECTIONS IN SCHOOLS Jana Fančovičová, Andrea Lešková	267
IN-SERVICE TEACHER TRAINING IN IBSE IN SLOVAKIA AND ITS IMPACT ON TEACHERS AND STUDENTS IN THE FRAMEWORK OF THE ESTABLISH PROJECT Zuzana Ješková, Katarína Kimáková, Mária Ganajová, Marián Kireš	272
A STUDY OF THE INFLUENCE OF SCIENCE MAGIC INSTRUCTIONS ON PRE-SERVICE SCIENCE TEACHERS' SCIENTIFIC LEARNING MOTIVATION AND CONCEPT APPLICATION Fu-Yi Shieh, Jen-Chin Lin	276
CREATIVE HANDS-ON ACTIVITIES WITH WATER, PAPER AND WIRE Alexander Kazachkov	281
FORENSIC – BIOLOGY WORKSHOP Tomáš Pinkr, Vanda Janštová, Jan Černý	284
PREPARING TEACHERS FOR THE USE OF ICT IN THE FRAMEWORK OF INQUIRY BASED SCIENCE EDUCATION (IBSE) – THE ESTABLISH APPROACH Ewa Kedzierska, Zuzana Ješková, Trinh Ba Tran, Ton Ellermeijer, Marián Kireš	290
LEARNING SCIENCE PROCESS SKILLS VIA CPD DESIGN MODULE Katarina Kotulakova	298
INTEREST IN THE SCIENCE – THE BREAKPOINT Juraj Slabeycius, Peter Hanisko, Daniel Polčín	303
THE TEACHER OF CHEMISTRY AND THE CREATION OF TEST ITEMS Tereza Kudrnová, Renata Šulcová	307
INNOVATION IN STATE CURRICULUM AND TEACHING NATURAL SCIENCES IN LOWER SECONDARY EDUCATION IN SLOVAKIA Mária Siváková, Peter Kelecsényi, Mariana Páleníková	312
BLENDED LEARNING FOR SCIENTIFIC INQUIRY: RESEARCH EVIDENCE FROM A US CLASSROOM Eva Erdosne Toth	318
PRESERVICE SCIENCE TEACHERS PERCEPTIONS ABOUT USING SCIENCE NOTEBOOKS: A COMPARATIVE INVESTIGATION OF UNITED STATES AND TURKEY SAMPLE İlke Çalıřkan	319
PRESERVICE SCIENCE TEACHERS EXPERIENCES WITH THE IMPLEMENTATION OF PROJECT BASED LEARNING Dogan Dogan, Eylem Eroglu Dogan	320
IMPROVING THE SCIENTIFIC PROCESS SKILLS OF ELEMANTARY PROSPECTIVE TEACHERS THROUGH HANDS ON SCIENCE PRACTICE: AN ACTION RESEARCH STUDY Necati Hirça, Mücahit Köse, Muhammet Usak	320
AN EXAMPLE OF INTERDISCIPLINARITY: PHYSICS, CHEMISTRY AND MATHEMATICS MERGE WITH BIOLOGY AND GEOLOGY IN AN URBAN FIELD TRIP Lídia Guimarães, A. Mário Almeida, Ricardo Rodrigues dos Santos, Manuel F. Costa	321

IS IT NECESSARY A FORCE FOR AN OBJECT TO MOVE? Alcina Rito, Rui Vila-Chã, A. Mário Almeida, Manuel F. Costa	322
EXPERIMENTS IN SCIENCE AT PRIMARY SCHOOL Jitka Houfková, Dana Mandíková, Zdeněk Drozd	322
WHAT HAPPENS NEXT? David Featonby	323
SECRET LIFE IN AN AQUARIUM FILTER Jan Mourek, Barbora Talavášková	323
DIGITAL TECHNOLOGIES IN EDUCATION	325
THE CARTOON GUIDE TO RELATIVITY Jan Novotný, Jindřiška Svobodová	327
ASSESSING THE ROLE OF SOCIAL NETWORKS IN INCREASING INTEREST IN SCIENCE AND SCIENCE LITERACY AMONG A SAMPLE OF FACEBOOK USERS Bisan Battrawi, Rami Muhtaseb	330
INVESTIGATION OF SEQUENCES USING DIGITAL COGNITIVE TECHNOLOGIES Stanislav Lukáč, Jozef Sekerák	338
VIDEO RECORDINGS OF SCHOOL PHYSICAL EXPERIMENT František Látal, Zdeněk Pucholt	343
AFFORDABLE TECHNOLOGY FOR EDUCATION IN PALESTINE Hamzeh S. Kirresh	347
HANDS-ON EXPERIMENTS AND ELEMENTS OF MODERN SCIENCE IN COURSE OF SCHOOL PHYSICS Denis Artemenkov, Victoria Belaga, Ivan Lomachenkov, Yury Panebrattsev, Natalia Vorontsova, Vladislav Zhumaev	351
WEB-DEVELOPER S TOOLKIT: TEACHING WEB-DEVELOPMENT AT TERNOPIL NATIONAL TECHNICAL UNIVERSITY Iryna Berezovska, Anatoly Solovyov, Oleksandr Matsyuk	352
ONLINE SCIENCE CLASSROOM Sergey Balalykin, Victoria Belaga, Alexandr Dirner, Evgenia Golubeva, Ksenia Klygina, Anna Komarova, Yury Panebrattsev, Alisa Potapova, Elena Potrebenikova, Pavel Semchukov, Alexandr Shoshin, Nikita Sidorov, Oleg Smirnov, Yulia Stepanova, Michail Stetsenko, Stanislav Vokal, Natalia Vorontsova	353
HOW VIDEOS CAN BE USED IN E-LEARNING – A CASE STUDY Sónia Seixas	353
AUTHOR INDEX	355

Inquiry based science education

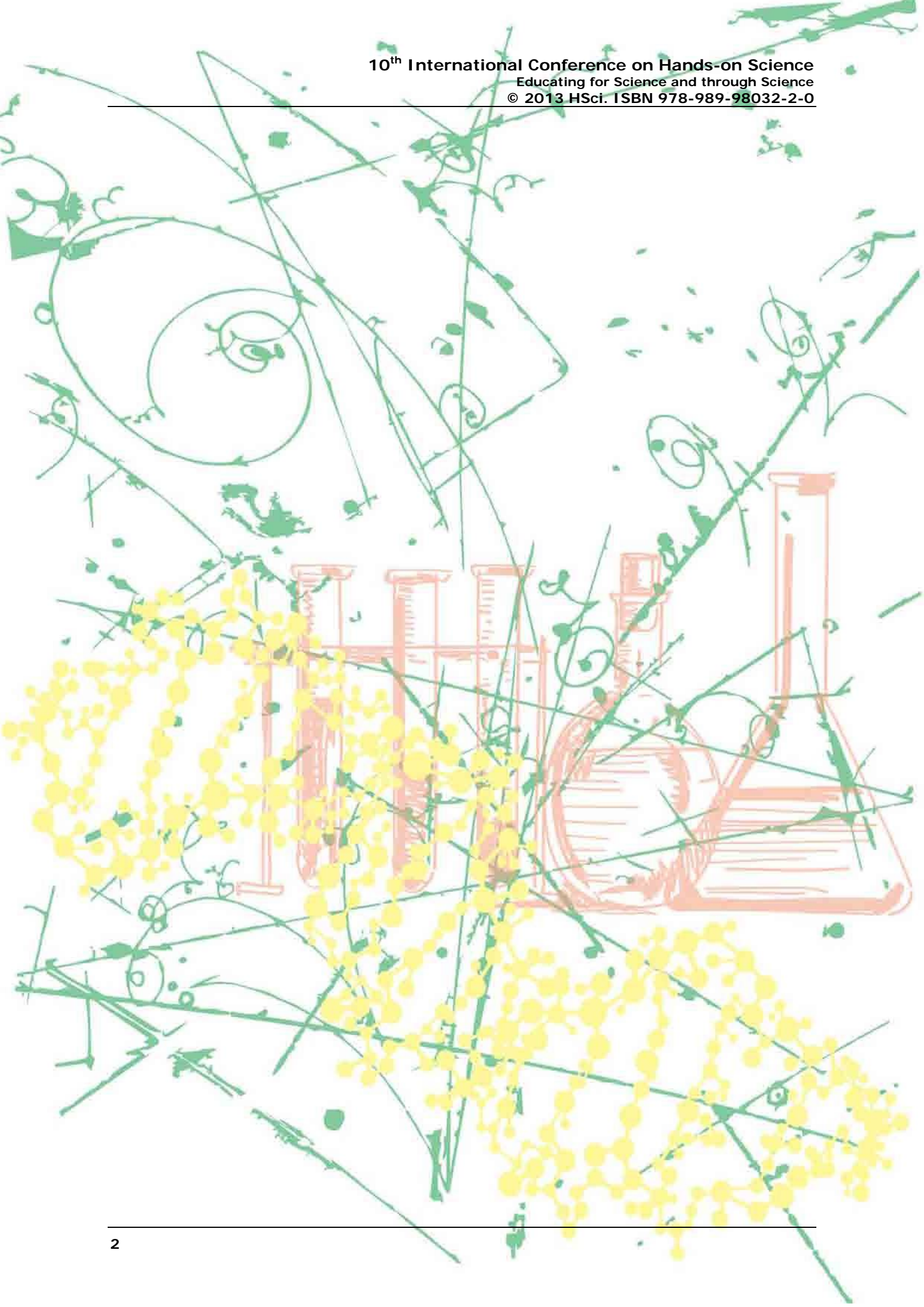

THE USE OF ICT IN THE FRAMEWORK OF INQUIRY BASED SCIENCE EDUCATION (IBSE)

Ton Ellermeijer

Foundation CMA, the Netherlands

Ton@cma-science.nl

Abstract. *The European Community wants science education to change in direction of IBSE (Rocard Report). Today several large projects involving many countries are addressing this challenge. The main focus is on preparing and supporting teachers by providing them with innovative curriculum materials and teacher training activities (as well pre-service as in-service).*

For a long time we know ICT might stimulate and enable science education in a direction that brings (high school) students in a similar position as researchers in science. The powerful tools available in the learning environment Coach (from measurement with sensors, advanced video-analysis to numerical modeling) facilitate realistic and authentic research projects by students.

Still many teachers around the world have not been able to apply these possibilities, also due to lack of training. In the framework of the ESTABLISH project (EC-funded) we now develop training and support for teachers as much as possible suitable for on-line use.

In this contribution the above mentioned aspects of science education will be addressed.

Keywords. IBSE, ICT, Science education, Teacher training.

The Coach learning environment

For a long time we know ICT might stimulate and enable science education in a direction that brings (high school) students in a similar position as researchers in science. Within the Establish project the learning environment Coach is used. Coach combines powerful tools for measurement with sensors, advanced video-analysis up to numerical modelling and facilitates realistic and authentic research projects by students (Heck et al, 2009).

Coach activities are mostly based on the selected tool for collecting, generating, or processing and

analysing data. Teachers can use ready-made activities or author new activities as parts of projects to structure the lesson materials (experiments). Activities may contain:

- texts with activity explanations or instructions;
- pictures illustrating experiments, equipment, and/or context situations;
- video clips or digital images to illustrate phenomena or to use for measurement;
- measured data presented as graphs, tables, meters, or digital values;
- models (textual, equations based, or graphical) to describe and simulate phenomena;
- programs to control devices and to make mathematical computations links to Internet sites and other external resources for students.

A basic description of several types of activities and concrete examples are given below.

In a *measurement activity* (time-based or event-based measurement, with or without triggering) students gain insight into data acquisition with sensors and how to set up measurement experiments. This understanding helps students interpret graphical representations of the data, especially because dynamic links between data and different representations such as graphs, tables, and meters are maintained during and after the measurement. Experiments are easily set-up (drag-and-drop sensor icons and automatic sensor recognition) with a variety of interfaces supported and a large library of calibrated sensors (e.g., for temperature, light, sound level, pH, etc.) and actuators (e.g., lamp, motor, fan, heating element, etc.) available.

Figure 1 shows a screen shot of the measurement and signal analysis of the voice sound 'eeh' recorded with the €Sense interface, which is mostly used at primary school or by beginners. The diagrams show that the sound signal is well described by a sinusoidal signal that consists of four frequencies. A visual representation of the €Sense interface with the built-in microphone is also present in the activity screen to make the experimental set-up clear to students. A text window is used for explanation and description of tasks.

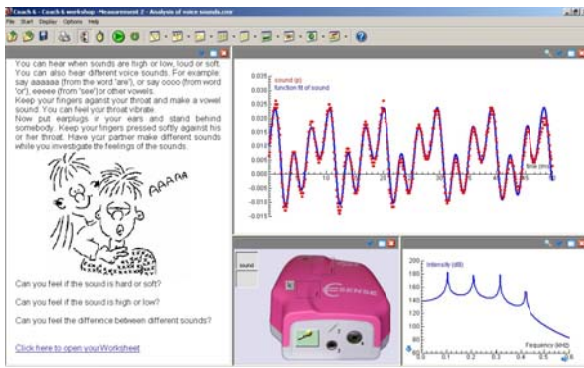

Figure 1. Measurement and signal analysis of voice sounds with the €Sense interface

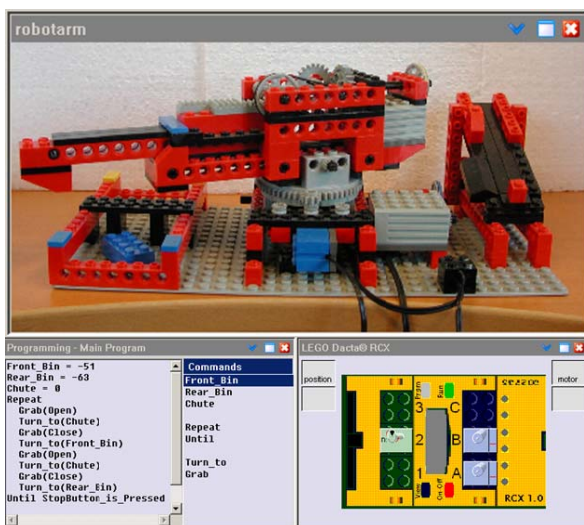

Figure 2. A computer microworld for manipulating a robot arm

A *control activity* offers several modes of programming with varying difficulty. These modes are manual control mode, instruction mode, microworld programming mode, and free programming mode using the Coach language. They are used to create and execute programs for automated measurements (for example, an automated pH titration system in which a titrator is controlled while measuring with a pH sensor), for manipulation of measurement data (for example, converting voltage signal from a sound sensor to decibels), for control of systems such as LEGO® models or models controlled by the CoachLab II interface, and for programming any phenomenon (mathematical, scientific, natural, artificial, or whatsoever).

Figure 2 is a screen shot of part of a control activity in which the Coach language has been used to create a programming microworld for manipulating the robot arm. The student's task has been to build with common LEGO® bricks

and the programmable LEGO® RCX a robot arm, and to construct a program with the supplied commands that makes the robot arm grab bricks, swivel around, and drop them into bins. A position sensor has been used to measure the position of the robot arm and two motors have been used to control the motion of the arm and grab.

Figure 3 is a screen shot of a *data video activity* in which position and time data are collected from a video clip. The video clip of the motion of a self-made yoyo that is winding up and down has been captured within Coach 6 through a webcam. The data recording in such a movie is often done by mouse clicking in selected frames on the location(s) of the item(s) of interest. In this case, the position of the point near the rim of the disk and marked by a sticker (P1) is measured in a slightly moving coordinate frame whose origin is at the hand of the person holding the end of the cord of the yoyo. But point-tracking makes the measurement at hand easier and less time-consuming: in the starting frame, the positions of the hand and of the sticker are specified and the shapes of the search areas (white boxes) are set, and then the coordinates of these points are automatically recorded in subsequent frames. In the diagram to the right, the horizontal position and the vertical position of P1 are plotted against time. This is combined in the diagram with a sinusoidal fit of the horizontal displacement of the yoyo, due to an unintentional pendulum motion of the yoyo, and a quadratic function fit of the vertical position during the first phase in which the yoyo unwinds. These trend curves can be used as coordinate functions of a computed point that is displayed in the video clip (P2): It turns out to be close to the position of the axle during the unwinding phase of the yoyo. For detailed modeling of the yoyo motion we refer to Heck & Uylings (2005).

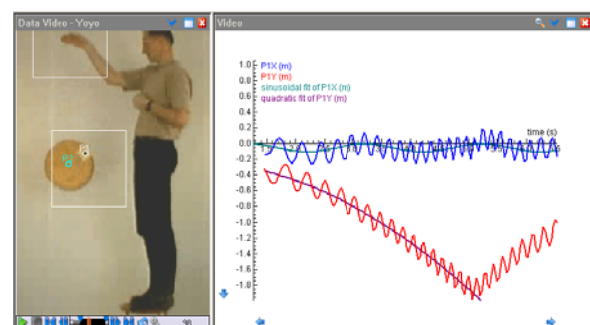

Figure 3. Screen shot of a video analysis activity about the motion of yoyo

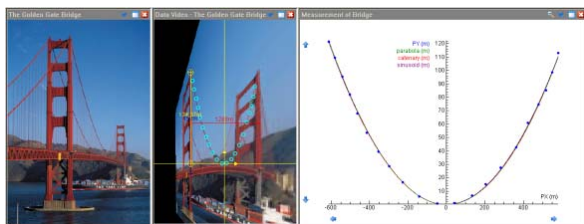

Figure 4. Screen shot of a photogrammetry activity with image rectification & regression

Data video and image measurement have potential for studying real world, everyday scenes of motion and for linking mathematics and science with the real world. An example of a measurement on a digital image that is otherwise difficult to realize is shown in Figure 4, in which the shape of the Golden Gate Bridge is investigated. The digital image to the left is the original picture but it is perspective distorted. Therefore data collection is done in a modified image in which a fronto-parallel view of the bridge has been realized. Technology can be used to raise questions: in the diagram to the right several regression curves that successfully match the recorded position data of suspension cable are shown, but which one is the best and on the basis of what criteria? In popular wording: tool use can turn brains on.

Instead of regression, one can also use numerical models to investigate the shape of the above bridge. A *modeling activity* offers the environment to create and run numerical models and to compare theory (the model) with measurement (experimental data). To this end, three types of model editors are available: text-based, equations-based, and graphical. Figure 5 shows a graphical model of the main span of Golden Gate Bridge that is based on the approximation of the suspension cable by k_{max} straight line segments with horizontally equidistant joint. The graphical elements represent a computer model, which provides in many cases a numerical solution of a system of differential equations.

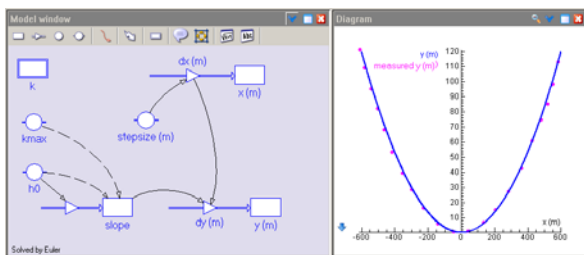

Figure 5. A graphical model of the shape of the Golden Gate Bridge

Coach is in fact a hybrid system that combines a traditional system dynamics approach with event-based modeling. This extends the set of realistic problems that can be solved by students without the need of sophisticated mathematics beyond their school level. Examples are models of yoyos (Heck & Uylings, 2005), bouncing balls (Heck et al, 2010), alcohol metabolism (Heck, 2007), and sprinting (Heck & Ellermeijer, 2009).

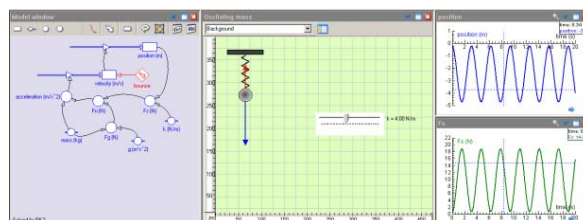

Figure 6. A graphical model of the harmonic motion of oscillating ball & an animation of the motion

The left window of Figure 6 shows a graphical model of a ball hanging on a vertical spring attached to the ceiling and that can also bounce against the ceiling; a special event-icon (with the thunderbolt symbol) is used to specify what should happen when the ball bounces. The window in the middle is an animation window that displays the simulation results as animations where model variables are presented as animated graphics objects. A student can interact with the animation through a slider bar, that is, select the value of the spring coefficient before the start of the simulation or change it while the simulation runs. Animation allows students to first concentrate on understanding a phenomenon with the help of simulations before going into the details of how the simulations have been implemented by means of computer models.

Establish Teacher Education Program

The overall model of the ESTABLISH teacher education programme has been designed to accommodate cultural variations among beneficiary countries and to be adaptable to facilitate both the timing of science teacher education workshops and to also cater for the varied experiences of the teacher participants. It is specifically built around the IBSE learning units that have been developed within the ESTABLISH project and consists of a common core supported by additional materials and resources to address aspects of implementation of IBSE within real classrooms.

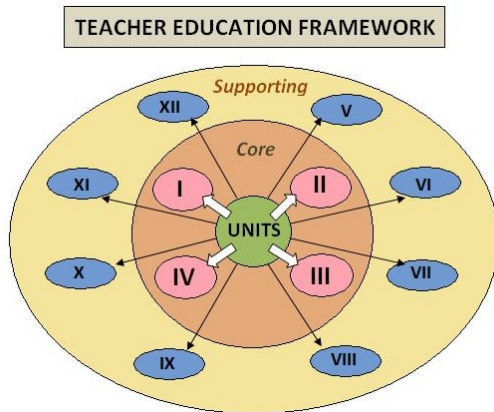

Figure 7. Framework for ESTABLISH Teacher Education

The model (Figure 7) involves a core number of elements (four elements) which form the backbone of all ESTABLISH teacher education programs. The core is then supported by a number of other elements (V to XII) that can be implemented as required to suit local teachers, environment, curriculum etc.

One of the elements, number VI, is the ICT for IBSE course. For this element a variety of support materials has been developed. These materials are organized in a Moodle environment and meant for blended settings, enabling an efficient course with limited life meetings. Course materials are applied by several partners of Establish in different settings (up to now in Slovak Republic, Italy and The Netherlands).

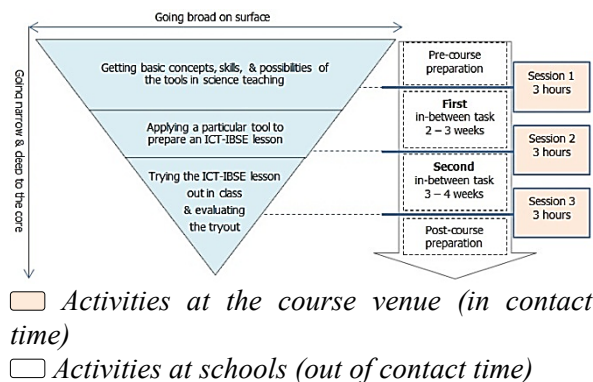

Figure 8. Participants' learning scenario

In the ICT-IBSE course, participants firstly get an overview of the ICT tools for IBSE (going broad on surface). Then they will personally choose which particular tool they want to learn and apply in classroom as a part of IBSE (going narrow & deep to the core). Participants are expected to fulfill this learning scenario (Fig. 8)

in which the time for in-between tasks is broadened for participants to be able to work with their own competence, experience, and interest flexibly.

Details on the course set-up, the developed materials and the effects on the participants' learning can be found in the paper of Kedzierska et al (2013) in the same Proceedings.

Conclusions

Looking back at twenty-five years of research on the use of ICT in education, curriculum development, and software, and hardware development it is fair to say that a lot has been achieved in the Netherlands. Hardware and software development, including the development of the working environment Coach, has been able up to now to meet more or less the requirements of trends in mathematics, science, and technology education such as the change towards context-rich education, emphasis on scientific approaches, better preparation for higher education through a stronger focus on competencies, and emphasis on individual learning and provision of students' autonomy over the process of knowledge and skills acquisition. This work will undoubtedly continue, due to the very nature of technology and education, and new demands from society. A sustained approach and concerted action of innovation, investment in infrastructure, teacher professionalization, and change of curriculum and examination lead to the best results.

References

- [1] Heck AJP. Modeling Intake and Clearance of Alcohol in Humans. *Electronic Journal of Mathematics and Technology* 2007, 1(3).
- [2] Heck A, & Ellermeijer T. Giving students the run of sprinting models. *American Journal of Physics* 2009; 77(11): 1028–1038.
- [3] Heck A, Ellermeijer T, Kedzierska E. Striking results with bouncing balls. In C. P. Constantinou & N. Papadouris (Eds.), *Physics Curriculum Design, Development and Validation, Proceedings of GIREP 2008*; Nicosia: University of Cyprus; 2009. p. 190–208.
- [4] Heck A, Holleman A. Investigating bridges and hanging chains. In M. Borovcnik, H. Kautschitsch (Eds): *Technology in*

Mathematics Teaching, Proceedings of the ICTMT 5 in Klagenfurt 2001, Schriftenreihe Didaktik der Mathematik v. 25, Vienna: öbv&hpt Verlagsgesellschaft; 2002. p. 409-412.

- [5] Heck A, Kedzierska E, Ellermeijer T. Design and implementation of an integrated computer working environment for doing mathematics and science. *Journal of Computers in Mathematics and Science Teaching* 2009; 28 (2): 147–161.
- [6] Heck A, Uylings P. Yoyo Joy. In: F. Olivero & R. Sutherland (Eds.) *Technology in Mathematics Teaching, Proceedings of ICTMT7 Vol. 2*; Bristol: University of Bristol; 2005, p. 380-387.
- [7] Kedzierska E, Ješková Z, Tran TB, Ellermeijer T, Kireš M. Preparing teachers for the Use of ICT in the Framework of Inquiry Based Science Education (IBSE) – the ESTABLISH Approach. *Proceedings of HSCI 2013*; Košice: Pavol Jozef Šafárik University in Košice; 2013 (in press).
- [8] Rocard M et al. *Science education now: A renewed pedagogy for the future of Europe*. Luxembourg: Office for Official Publications of the European Communities, 2007.



THE PHYSICS OF THE DRIVEN SPINNING TOP

Ioan Grosu^{1,2}

1-Medical Bioengineering Faculty, Univ. of Medicine and Pharmacy, Romania

2-Chemistry Department, Al.I.Cuza University

igrosu@mail.umfiasi.ro,

ioan.grosu@chem.uaic.ro

Abstract. The new toy and didactic device Driven Spinning Top is introduced by showing how it is built: just using two permanent magnets. It is magic, interactive, educative, scientific, improves patience, perseverance, hand-eye coordination, practical/technical skills and is equally liked by girls and boys; it is suited for students of all ages. All explanations are given based on the law of conservation of angular momentum and Bernoulli law. Some

future projects are suggested.

Keywords. Angular momentum, Driven Spinning Top, Engineering, Physics.

1. Introduction

The Spinning Top is one of the best known and most beloved toys along the history. More than 2000 years mankind used this toy. It is known under 109 different words in 109 languages [1,2]. It is known a famous picture of Wolfgang Pauli and Niels Bohr looking at a Spinning Top. [3].

The Earth and other astronomical bodies are huge Spinning Tops. They have magnetic moment too but its influence on the dynamics is negligible. This is not the case at the atomic level. Protons (in water molecules and organic molecules) have angular momentum and magnetic momentum. They “feel” the external magnetic field and this is at the bottom of the Nuclear Magnetic Resonance (NMR) or Magnetic Resonance Imaging (MRI) or functional MRI (fMRI). Actually, the author started from here and the results have been adapted to the Spinning Top. Also other atomic particles (electrons, neutrons) have angular momentum and magnetic momentum.

As a toy the Spinning Top fascinates because it keeps vertical position when rotates; without rotation the vertical position is an unstable equilibrium. This is explained by nothing else than the law of conservation of angular momentum ($dL/dt=M$, L - angular momentum, M - external torque; if $M=0$ then $L=constant$, it means that the angular momentum is conserved or rotation is conserved).

2. Driven Spinning Top

Any try to move a Spinning Top in a certain direction fails. If we touch it, this is equivalent with a torque of friction and the rotation is decreased or it will jump in an undesired direction. We have to keep in mind that to keep the rotation we need to not introduce any torque. 7 years ago [4,5] we modified the classical Spinning Top using two permanent magnets (Fig. 1).

The two permanent magnets are attracting but their force of interaction passes the axis of the Spinning Top and introduce no torque. It means that the rotation is preserved and just the translation is obtained. With this modification

the classical Spinning Top is a Driven Spinning Top and it is qualitatively different from the classical one[6].

This can be observed here [7,8].

If a ball is fixed on the small magnet then when they stick together the rotation continues. Children do not expect this but by touching they realize it and after a while looks just obvious to be like this. This is a technical solution: a joint with two degrees of freedom or a spherical pendulum.

3. A new toy and didactic device

The magic of the Driven Spinning Top is much more than the magic of the classical Spinning Top. This comes from the fact that the new one is interactive. Several tasks can be done: competitions, chain of tops and a game topball. To drive the Spinning Top we need to hold the second magnet vertical above the top at 2-3 cm and move it slowly. If the second magnet is moved quickly the top cannot follow. By playing children and students of all ages improve hand-eye coordination, patience, self-confidence, attention, perseverance, practical/technical skills. It is equally liked by girls and boys (this is important because girls can get more self-confidence concerning technical matters). It can fight against Internet Addiction.

4. The Physics of the Driven Spinning Top

The horizontal driving is obtained because the force between 2 magnets does not introduces a torque, it means that the angular momentum is conserved and the rotation is not changed.

If on the small magnet a ball of iron is fixed then when the two magnets are close enough and stick together the rotation continues. The ball assures a point-like contact it means a small friction. If we shake the second magnet the top falls and continue rotation. In both cases the forces of interaction do not produce any torque. Again, this is a new technical solution that is not met at other toys or didactic devices. If we put the bottom of the suspended top to the top of the second rotating top and we lift off we obtain a chain of two rotating tops. This gives a lot of fun to children but again has its explanation in conservation of the angular momentum.

If a top is driven to a wall it will collide the wall. If we drive two tops with cylindrical external shape close one to another they will collide. It can be observed and a sound can be heard. Around

the rotating top a flow of air is expected. We can feel it by putting a finger near the cylindrical shape of a top. In this flow a dynamic pressure exist and the Bernoulli law from fluidics can be applied. If we drive a Driven Spinning Top near to a glass ball they will collide and the ball will be moving rather far from the top. This can be used to propose a game: topball. Two players each with a Driven Spinning Top, a ball and two gates. Each player will drive the top to collide the ball and to bring it in the opposite gate. To play this game it is not needed to push children to do it and no explanations are necessary.

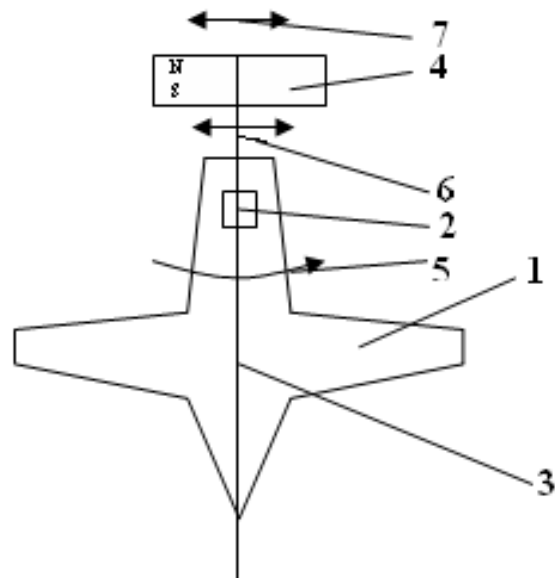

Fig.1. Schematic of the Driven Spinning Top

- 1-spinning top,
- 2-small permanent magnet,
- 3- rotation axis,
- 4-external permanent magnet,
- 5- rotation motion,
- 6- movement of the top,
- 7- movement of the external magnet.

Precession is a rather complicated motion[9]. It is involved in the dynamics of the solid body and in NMR (the nuclear spin is rotating around the external magnetic field). These can be taught in the first 2 years of the university studies. We state that if the students play with the top they will learn easier the full Physics and Engineering of the tops [11]. Quantitative measurements can be done: measuring the frequency of rotation around its axis and the frequency of rotation around vertical axis. The product of the 2 frequencies should be approximately constant.

Driven Spinning Top can be offered to students of all ages. As our Ministry of Education recommends it can be used as a toy for primary school students, toy and some Physics for secondary school students, more Physics for high school and the full Physics and Engineering for first two years of university studies[11]. Even the teachers use to “wow” when they see for the first time [12]. Driven Spinning Top is commercially available [13].

5. Future projects

We do believe that if the Driven Spinning Top will be used by many people (teachers and students of all ages) many questions will arise: some will get right answers, others will remain open for a while and many contradictions will be triggered [10]. Also some original ideas could show up. We propose here 4 future projects:

-A simple experiment can be done by fixing the second magnet as close as possible to a Spinning Top but the top to stay still on the surface. In this manner the normal force on the surface is minimum and the friction is minimum. The rotation should last much longer.

-Another experiment can be done exactly like the previous but to work in low pressure(vacuum). In this case the friction with air is much reduced and the rotation should last even longer.

- To imagine a manner of rotation of the top in the sense of rotation to compensate the friction...many people asked us but we did not have an answer.

-At last would be a project that improves the Levitron [14]. Levitron is an excellent and fascinating experiment but it is hard to be obtained. We met several people that bought a device but did not have the chance to see it working properly.

9. References (and Notes)

- [1] <http://www.topmuseum.org>
- [2] <http://en.wikipedia.org/wiki/Top>
- [3] R.Roller, Kreisel,, H.Hugedubel Verlag, 1989
- [4] <http://www.supermagnete.de/project72>
- [5] <http://drivenspinningtop.blogspot.ro>
- [6] Kaysel S, Kaysel R. Kreisel, Schweizer Kindermuseum Baden, Switzerland
- [7] http://www.youtube.com/watch?v=Vpo_T8

sq2SM%2F

- [8] http://www.youtube.com/watch?v=LauHISuq_ms&feature=player_embedded%2F
- [9] Tipler PA. Physics for Engineers and Scientists, Worths publishers, 3rd edition, 1991
- [10] David Featonby, Dare we teach tops ?, Physics education 45, p.409, 2010
- [11] http://files.eun.org/scientix/posters/Poster_Scientix_Spinning%20top.pdf
- [12] <http://www.youtube.com/watch?v=RCK9A4jqdtI%2F>
- [13] <http://www.rekubus.eu/top-speedy>
- [14] Simon MD, Heflinger LO, Ridgway SL, Am. J. Phys. 65, 286, 1997



GAMES, GAMES AND GAMES

Aslı Taşcı, Ebru Aghasi
İTÜ Geliştirme Vakfı Okulları
asli.tasci@itugvo.k12.tr
ebru.aghasi@itugvo.k12.tr

Abstract. *Various methods and techniques are used to create effective, permanent and meaningful learning in science education. Classroom activities, classroom experiments, cooperative learning, puzzling, testing and learning by doing are some of them. The most common purpose of these methods and techniques are getting learner more active and more participated during the learning process in the classroom. Among all of these topics, games have a special mystery in learning and teaching science.*

Keywords. Science, Education, Game, Student

No matter what the age of the student is, learning science through games is a very important technique in the classroom. In all stages, students have a good time and they learn many things while enjoying. Also games are useful for students who have trouble focusing on the topics. For many students who have weak/short attention span, educational games can be very useful. A qualified educational game is not only helping to learn, it also has the kids enjoy. The students also find this way easier to learn. In addition to that, games develop personal skills like, memorization, consideration, making

decisions and conclusions. Also, it is a fact that games are helpful to teach subjects, beside science. For instance, many games teach the importance of taking turns, waiting a friend, acting in a group and time-management. Even it can be helpful to develop their reading and writing skills.

In this study, we will mention some games that are consulted by students. There are five games and these games are based on biology, chemistry and physics. 'Teomanya' which is about matters in the chemistry; 'Force in Force' and 'Electric, me and you' which are the subjects in physics; 'Trees and Continentals' and 'Body Systems' which are the subjects in biology are the names of the games. 'Teomanya', 'Force in Force', 'Electric, me and you' and 'Body Systems' are the games that can be played by two or four people. 'Trees and Continentals' can be played by all the students in the classroom.

The studies develop the students science skills of students observing, making comparison, guessing, planning a experiment, measuring, recording and making conclusions. On the other hand, the science study facilitate mathematical skills of students such as comparing, classifying, recording data, making graphics and tables. Also, the studies makes the cooperation between students.

- [1] Rose S. Why Educational Games are Important in Classroom. Publishing; 28 July 2010.
- [2] Bağcı N, Bahadır Ö, Enik C, Evecen M, Koç R. 5. Sınıf İlköğretim Fen Bilgisi Kitabı Ankara: MEB, Publishing; 2012



IPPOG – BRINGING PARTICLE PHYSICS INTO CLASSROOMS

Ivan Melo on behalf of IPPOG network

*Department of Physics, University of Žilina,
melo@fyzika.uniza.sk*

Abstract. *The International Particle Physics Outreach Group, IPPOG, is a network of particle physicists, researchers, teachers and informal science educators engaged in worldwide outreach and informal science education for particle physics. IPPOG's aim is to raise awareness, understanding and standards of global outreach efforts in particle physics and general science.*

IPPOG has initiated several major activities that engage students in hands-on activities, such as the well-established "International Particle Physics Masterclasses" which brings LHC data from CERN into the classroom and "Cascade," a new video competition for high school teams. The aims and activities of IPPOG will be described, including Masterclasses, Cascade and the IPPOG outreach database, that holds recommended tools and materials to be used in formal and informal education settings to bring the exciting world of particle physics to students of all ages, teachers and the general public. We show how students, teachers and particle physicists can benefit from the work of IPPOG and join in its activities.

Keywords. Hands-on activities in particle physics, outreach database, high school students competition, IPPOG, Master classes.

1. Introduction

International Particle Physics Outreach Group (IPPOG) is a network of physicists and science educators engaged in informal science education and outreach for particle physics [1]. It was formed in 1997 under the joint auspices of the European Committee for Future Accelerators (ECFA) and the European Physical Society's High Energy Particle Physics Board. IPPOG's growing membership currently includes representatives from each member state of CERN, each major experiment at CERN's Large Hadron Collider (LHC) and prominent labs and institutions in the USA and Europe.

IPPOG's aim is to maximize the impact of

education and outreach in particle physics through information exchange and the sharing of expertise and thus strengthen cultural awareness, understanding and support of particle physics and related sciences across the globe.

We would like to serve anyone who wants to know more about particle physics, especially educators and students (from school to university). We share the view of the former CERN Director General Mr. Llewellyn Smith who said at the first-ever IPPOG meeting “the particle physics community has a moral obligation to inform the public on its activities. To do this well, experiences must be shared among countries in view of the need to optimize the use of resources.”

The group meets twice each year: once at CERN and once elsewhere. First IPPOG meetings were almost exclusively used for exchanging education and outreach ideas and resources, where each country or experiment presented their core activities and gained some insight into outreach efforts elsewhere. Later IPPOG became more proactive organizing its own activities such as International Particle Physics Masterclasses and the database of outreach material discussed below in more detail.

A growing number of initiatives changed the format of IPPOG's meetings which now feature focused working groups to address specific needs of the community. They include, e.g., IPPOG identity and new membership working group (to extend original European nature of the group to a truly international one), IPPOG at conferences (to communicate importance of outreach among physicists and to provide them with useful tools and ideas), Social media, Masterclasses and Higgs mechanism (to explain what the Higgs boson is all about) working groups.

IPPOG can help students telling them about outreach programs in their area and how to get involved and point them to recommended learning resources on-line. Teachers can benefit from our recommended tools and materials for their classroom audiences and scientists from recommended tools and materials to effectively engage young people during talks, presentations, and discussions.

2. International Particle Physics Masterclasses

Masterclasses bring the excitement of cutting-edge particle physics research into classrooms.

Originating from Great Britain, Masterclasses turned international in 2005 under the coordination of IPPOG [2]. It became a very popular activity for high school students from all over the world who come each year in the spring to nearby universities or research centers to become “scientists for a day” [3]. Masterclasses are rapidly expanding. In 2013, 10 000 students in 37 countries and 150 universities took part in the event over 4 weeks.



Figure 1. Masterclass participants

The format of the day includes three key elements:

i) lectures from active scientists give insight on topics and methods of fundamental research on the building blocks of matter and the forces between them ii) active participation of students in measurements on real data from LHC particle physics experiments ALICE, ATLAS and CMS and iii) international videoconference moderated from CERN during which students compare and combine results with their peers in other countries and discuss physics with the moderators. The main purpose of masterclasses is to expose students to the scientific process and share our excitement about physics with them.

In the key measurement part students learn to use event display programs and analysis methods. They first practice particle identification by exploiting the characteristic signals left by particles in various subdetector elements; electrons, muons, photons and jets of particles are then recognised. The students then categorize events and measure various properties of some known particles, such as the weak gauge bosons W and Z and a number of hadrons (J/ψ , Y , Λ , K s). Finally, they learn how to use the concept of invariant mass in the search for new particles. Below we describe the measurements performed.

2.1. ATLAS Measurement

2.1.1. W-path analysis

There are two independent paths to perform measurements based on ATLAS data: W -path developed at University of Dresden and Z -path developed at University of Oslo [4].

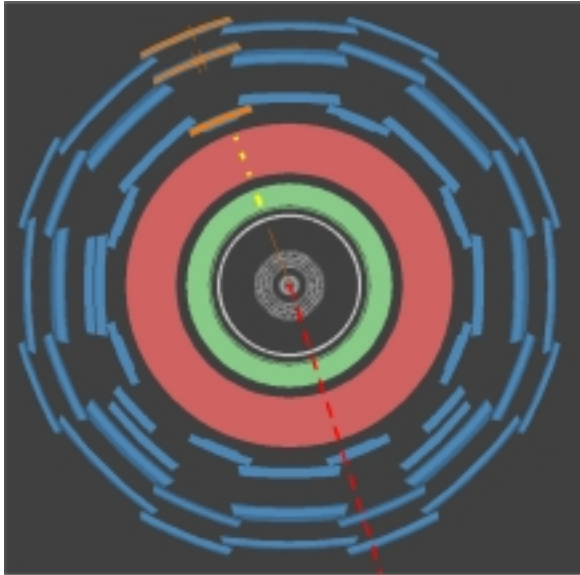

Figure 2. $W \rightarrow \mu \nu$ event in Atlantis

The ATLAS W -path [5] offers students a possibility to search for W^+ and W^- bosons in the data through their leptonic decays $W \rightarrow l \nu$ where l is an electron (positron) or muon (antimuon) with a high transverse momentum and large missing transverse momentum due to the neutrino which escapes detection. Students identify W bosons with the event display software Minerva based on Atlantis [6], see Fig. 2. The challenge of the task is to recognize W candidates among many different kinds of background events such as QCD jets, Z events and top quark events. By measuring the ratio of the number of W^+ to the number of W^- bosons students probe the proton structure: a ratio larger than 1 indicates that there are more u quarks than d quarks in the proton.

Once the students can recognize W boson candidates, they can also search for the Higgs boson in the data, using its decay channel to two W bosons, $H \rightarrow W^+ W^- \rightarrow l^+ \nu l^- \bar{\nu}$, characterized by two opposite charge leptons with high transverse momentum and high missing momentum due to two neutrinos.

2.1.2. Z-path analysis

Within the Z -path [7] students search for Z

bosons in their leptonic decay channels, $Z \rightarrow l^+ l^-$ where l is again an electron or a muon. The Z -path introduces the invariant mass concept as a powerful tool used by particle physicists to identify short-lived particles and search for new ones. Students learn how invariant mass is constructed and used to distinguish the signal (Z boson events) from many background events which include J/ψ , Y , Drell-Yan, and other QCD and W background events.

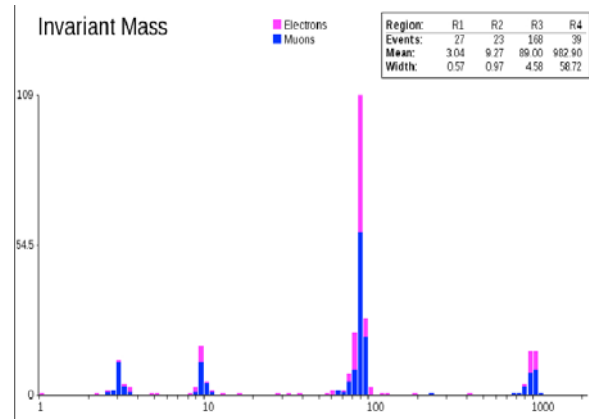

Figure 3. Invariant mass distribution with Z peak at 90 GeV and hypothetical simulated Z' peak at 1000 GeV

The students also search for the Higgs boson in the two discovery channels, $H \rightarrow ZZ \rightarrow l^+ l^- l^+ l^-$ and $H \rightarrow \gamma \gamma$. The Higgs boson candidates have invariant mass at about 125 GeV, the mass observed by ATLAS (and CMS). Finally, if students carefully analyze data, they can also ‘discover’ a new hypothetical particle, Z' , at a mass of 1000 GeV. Z' events were simulated and mixed with real data to illustrate that the analysis can yield new and sometimes unexpected results. Z' particle is predicted by several extensions of the Standard Model of particle physics.

The HYPATIA event display [8] which is also based on Atlantis is used to go through a subset of 50 events per pair of students.

2.2 CMS Measurement

CMS is the second large general purpose detector at the LHC. Working independently and using different detection techniques, ATLAS and CMS bring vital confirmation of each other's results. The CMS Masterclass measurement includes both W and Z -paths in a single exercise [9]. The physics behind is the same but events look somewhat different, partly due to the difference between the two detectors and partly due to the iSpy event display software [10] used

by the CMS measurement. The CMS tracker has stronger magnetic field than ATLAS and charged particle tracks are curved more as a result. The students can easily find the charge of the particle from the curvature and thus tell apart electron from positron or muon from antimuon (the charge is determined in the ATLAS detector in the same way but not by the students). An interesting feature of iSpy is that students (or anybody else) use it online without having to download it and the same applies to the data.

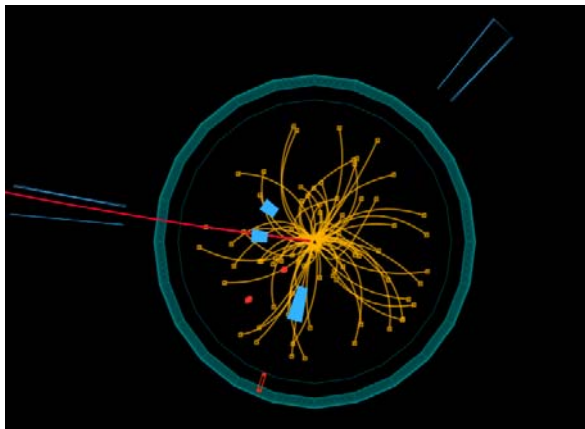

Figure 4. A detail of a CMS event with curved tracks in iSpy

2.3 ALICE Measurement: Quark-gluon plasma analysis

ALICE is the third large LHC experiment whose aim is not to search for new particles but rather study properties of a new phase of strongly-interacting matter, the so called quark-gluon plasma (QGP) and the phase transition from QGP to the hadron gas state prevailing at lower energies. Results from these studies will lead to a better understanding of the conditions of the early Universe.

Students use a simplified version of the ALICE event display to look for strange particles K_s , Λ and anti- Λ [11]. They count their numbers and compare them with Monte Carlo predictions as well as with published results. The goal is to see enhancement in these numbers as one moves from proton-proton collisions to lead-lead collisions which is an important signal of QGP.

2.4 Future steps

Our surveys show that the level of complexity of measurements is just right and that students appreciate all parts of the program. Growing interest in Masterclasses leads us to consider also local, less time-consuming alternatives, dubbed

mini-masterclasses, currently tested in a number of countries. We have also tried to apply the format to the fields of astronomy and cosmic rays with equal success. We collect all tools and materials at International Masterclasses homepage [1] and in the IPPOG database (see below) [12]

3. Cascade projects competition

International Particle Physics Masterclasses (MC) are successful in motivating high school students. However, it is only a one day event and some of the students are ready for further adventure. Cascade projects offer a chance for those who would like to get deeper into the realm of particle physics. The format was developed at the University of Birmingham in 2006/2007.

In the Cascade competition teams of 3 - 6 high school students work for several weeks on projects on topics from particle physics and cosmology and then make 20 minutes presentations in their schools. The teams are helped by mentors (volunteers from the high energy physics community) and their teachers. Teams then send videos of their presentations plus PowerPoint files to the Cascade organizers, where the best teams are selected and invited to the Grand Final.



Figure 5. Cascade team in the Great Final

The best team in the Final wins a trip to CERN. The format is a success. Students enjoy working in teams and presenting in public. In Slovakia the number of teams rose from four in the 1st year to sixteen in the 3rd year of the competition. Masterclasses is a good springboard for Cascade. Most of the teams are formed from former Masterclass participants.

The competition is relatively easy to organize. The first round (presentations at schools) does not require presence of the organizers. The

Grand Final is jointly organized by one of the high schools and a university. Teams present their projects in front of the jury and the high school audience. The best Cascade projects have the qualities we had hoped for: a solid scientific content and fresh, entertaining presentations which are a fun to watch. Team members are often interested in pursuing a scientific career. For more details see [13].

4. IPPOG resources database

A new IPPOG initiative, the database is the first-ever global database for materials related to particle physics outreach and informal education [12]. It houses videos, brochures, posters, talks, ideas for hands-on activities in a variety of languages. Items stored here are shared by members and partners of the IPPOG network.

The aim of the collection is to help physicists, communicators and teachers find new ways and tools to teach particle physics in their classes and in public.

New items can be submitted after registration by anyone. The database can be searched by the learning topic, audience, item type, topic and language. A rating system enables users to give credits to the popular items.

The database is still in its early stages and we invite users to make suggestions that could help improving it.



Figure 6. IPPOG resources database

5. Acknowledgements

I would like to acknowledge support of KEGA grant agency project 022ŽU-4/2013.

9. References

- [1] International Particle Physics Outreach Group – IPPOG, <http://ippog.web.cern.ch>, <http://facebook.com/IPPOG>
- [2] International Particle Physics Masterclasses, www.physicsmasterclasses.org
- [3] European particle physics masterclasses make students scientists for a day. K E Johansson, M. Kobel et al. Physics Education 2007 42, 636
- [4] LHC@InternationalMasterclasses, <http://atlas.physicsmasterclasses.org/en/index.htm>
- [5] Jende K, Kobel M, Pospiech G, Bilow U, Rudolph C, University of Dresden, <http://atlas.physicsmasterclasses.org/en/wpath.htm>
- [6] MINERVA, McLaughlan T, Stockton M, Watkins P (University of Birmingham), Wielers M. (Rutherford Appleton Laboratory), <http://atlas-minerva.web.cern.ch/atlas-minerva>
- [7] Pedersen M, Ould-Saada F, Gramstad E, Bugge M, University of Oslo, The ATLAS Z-path, <http://atlas.physicsmasterclasses.org/en/zpath.htm>
- [8] HYPATIA, Kourkoumelis Ch, Fassouliotis D, Vourakis S (University of Athens), Vudragovic D (Institute of Physics, Belgrade), <http://hypatia.phys.uoa.gr>
- [9] Cecire K and collaborators, University of Notre Dame, QuarkNet collaboration, CMS Masterclass W/Z-Measurement, <http://cms.physicsmasterclasses.org/pages/cmswz.html>
- [10] iSpy-online, Hategan M, Ngyuen P, McCauley T, i2u2 and QuarkNet collaborations, <http://www.i2u2.org/elab/cms/event-display>
- [11] Debski PR, Foka P, Hatzifotiadou D, Hippolyte B, Maire A, Tadel M, Proceedings of the 7th International Conference Hands-on Science Bridging the Science and Society gap, July 25 – 31, 2010, Rethymno – Greece.

<http://aliceinfo.cern.ch/public/MasterCL/MasterClassWebpage.html>

[12] IPPOG resources database,
<http://ippog.web.cern.ch/resources>

[13] More information on Cascade in IPPOG database:

<http://ippog.web.cern.ch/resources/2011/cascade-projects-slovakia>



CONNECTING CLASSROOMS TO THE MILKY WAY

Roger Ferlet

*Institut d'Astrophysique de Paris – CNRS /
UPMC
ferlet@iap.fr*

Abstract. *The European Hands-On Universe (EU-HOU) project has implemented the first network of radio telescopes dedicated to education. Six small antennas in five different countries open the radio wavelength domain to classrooms and offer the possibility to map the neutral hydrogen in our Galaxy, the Milky Way. A complete educational scenario has been produced, enabling students to discover by themselves the existence of dark matter in the Universe.*

Keywords. Digital technologies in education, Inquiry based science education, Milky Way kinematics, Radio observations.

1. Introduction

The EU-HOU-MW project is part of the COMENIUS European Commission Lifelong Learning Program (2010-2012). Very active since 2004, the EU-HOU consortium has the following objectives: i) to raise the attractiveness of science education, ii) to participate to the development and modernization of learning technics in EU schools, and iii) promote the scientific method/knowledge. The present project was built in the perspective of the future large international radio facilities ALMA (Atacama Large Millimeter Array) and SKA (Square Kilometer Array); it involves 11 European countries. The consortium has delivered educational material (updated versions of the

SalsaJ software, exhibition on Radio-Astronomy, pedagogical resources including kinesthetic activities), organized teachers training sessions, and built a radio-telescope network for teachers and schools.

2. Radio-astronomy network

We have developed the first European network of radio-telescopes for education, enabling European schools to explore our Galaxy the Milky Way via the neutral hydrogen H I emission line at frequency 1420 MHz (or 21,1 cm wavelength) with Internet and a simple web browser. The scientific goals are i) to derive the Milky Way rotation curve and discover the need of dark matter, and ii) to map the Milky Way spiral arms structure and discuss our place in the Universe. In order to do so, we provide the teachers with multilingual tools: a scheduling system to access the telescope, a remote access to the six T3m radio-telescopes (see e.g. Fig. 1), archives to retrieve and/or analyze previous observations and a simulator of observation enabling to perform (off-line) the exercises with high quality data (LAB survey, Kalberla et al., 2001). The Internet Control Web page of the EU-HOU-MW Small Radio-Telescope Network is accessible from the project Web site <http://www.euhou.net/>.

Any teacher can go to this page and register. Once he has open an account (under the control of a local administrator), he can book a free time slot on any antenna of the network. The connection to the Observer page (the remote control interface) will be possible during this time slot only. Simple inputs are required: position on the sky, observing frequency, integration time. The interface provides the users with interactive maps in Az/El and Galactic Long/Lat coordinates. A webcam shows the telescope moving in real time.

Once the observations are done, the spectrum is displayed and the user can remove a baseline and/or redo an observation. This spectrum can then be directly retrieved from the Archive, where more analysis can be performed. The user can select some peaks in the H I spectra. These peak velocities, together with the Galactic coordinates of the pointed region, can be translated into a rotation velocity and a radius (by simple geometric arguments) and/or into an x/y position in kiloparsec (kpc) on the face-on Milky Way plot. Those two outputs are directly computed by the interface from the selected

peaks and compared to professional data outputs and to some modeling of Galaxy potential wells and spiral arms (see Fig. 2).

In order to remotely control the antenna, we used the java control system delivered with the antenna and the receiver (from the MIT Haystack observatory). The EU-HOU-MW interface was designed in javascript, php and python, like a wrapper which uses the original control system commands. It also includes analysis tools, administration tools, and the communication protocols. The telescope outputs are also connected to a SQL database to archive the data and post-process or download them. A central server hosts the archive, the *Scheduler*, the *Account manager*, the homepage and the identification protocols to authorize the connection to each antenna. The Observer pages are hosted on local computers directly connected to the antennas in France (Paris), Poland (Cracovia), Portugal (Pampilhosa), Romania (Craiova) and Spain (Madrid).

3. Pedagogical support

While a lot of efforts have been dedicated to the development of tools easy to be used by secondary schools pupils, these tools need the pedagogical and scientific explanations that could benefit to the learners. The challenge was twofold: 1) because the observations of redshifts and blueshifts are made from the moving platform of the Solar System which furthermore is located within the rotating Galaxy, it is difficult to conceptualize the relative motion of the Sun and the observed H I clouds for different quadrants of the Galaxy, and 2) the principles of a rotation curve computation and of the Galactic spiral structure determination are not easy to understand. To address these difficulties, a kinesthetic activity has been developed in order to “visualize” the rotation of the Milky Way, the Galactic system of coordinates, as well as the blue and red-shifts of the velocities along different lines of sight. This activity has been video-taped and translated in English.

After this attractive introduction, teachers have acquired some intuitive understanding of the mathematics, and they can go through the technical calculations of the velocities rotation curve; they are then introduced to the Web interface and asked for reproducing with the EU-HOU-MW simulator the phenomena they experienced during the kinesthetic activity. An exhibition presenting radio-astronomy and its

challenges has been prepared in two versions, one for middle schools, and one for high schools. It shows some key concepts to understand the basics of radio-astronomy such as wavelengths, cosmic radio-sources, use of radio-wavelengths in the world surrounding us, etc.

Of course, this radio-telescopes network can also be used to introduce University students to radio-astronomy. In that case, instead of the remote control interface, we use the original java software which is more flexible.



Figure 1. The two antennas assembled at Observatoire de Paris

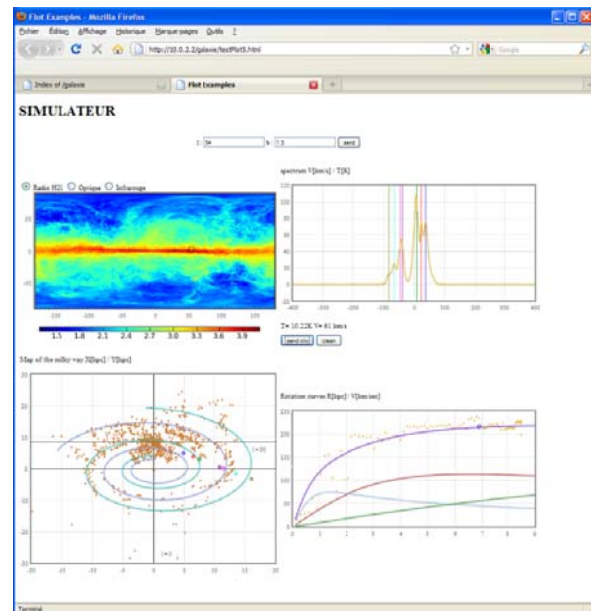

Figure 2. Milky Way view (upper left panel); Milky Way spiral arms (lower left panel) and rotation curve (lower right panel) derived from H I spectral observations (upper right panel) with the EU-HOU-MW simulator.

Observations such as calibration of the antenna temperature, pointing of the Sun, are then

possible and can be analyzed with a python library specifically prepared. In fact, much more material can be added to the webpages for illustrating radio-astronomy principles (heterodyn receiver, interferometry, continuum/line observations) as well as the related astronomical topics (galaxies structure and content: dust, gas, stars, dark matter...) and the ongoing science. It is hoped that our evolutionary tool will not only provide pupils with an idea of what real science is, but also inspire some of them to consider a scientific carrier.

Synergies exist with several research institutes outside the EU-HOU-MW network that have acquired the same kind of small radio-telescope for outreach or education purposes: Nançay and Toulouse in France, Bologna in Italy, Hanoi in Vietnam. Any of these antennas can easily be integrated into the EU-HOU-MW network.

4. Acknowledgements

The coordinators of the EU-HOU-MW project were Anne-Laure Melchior and Roger Ferlet. They want to warmly thank all the EU-HOU-MW team at Paris Observatory, including Alexander Rudolph, as well as the 11 partners of the project: France – Université Pierre & Marie Curie; Spain – Universidad Complutense de Madrid; Portugal – Nuclio Interactivo de Astronomia; Greece – National Observatory of Athens; Cyprus – Lykeio Agiou Ioanni; Poland – Jagiellonian University; Romania – University of Craiova; Belgium – Royal Observatory of Belgium; United Kingdom – Glamorgan University; Sweden – Stockholm House of Science; Germany – Förderverein Astropeiler Stockert e.V.

5. Reference and Note

- [15] [1] Kalberla PMW et al., *Astronomy & Astrophysics* 2005; 440, 775
- [16] [2] This project has been funded with support from the European Commission. This publication reflects the views only of the authors, and the Commission cannot be held responsible for any use which may be made of the information contained therein.



THE CITY BRIDGES PROJECT: CONNECTING PEOPLE, MERGING SCIENCES

Alexander Kazachkov¹, Marián Kireš²,
Abraham Salinas Castellanos³

¹*V.Karazin Kharkiv National University
Kharkiv, Ukraine*

²*P.J.Šafarik University, Angelinum
Košice, Slovakia*

³*CECyT Carlos Vallejo Márquez, Instituto
Politécnico Nacional
DF, México*

¹*akazachkov@yahoo.com*

²*marian.kires@upjs.sk*

³*abrrahams@yahoo.com.mx*

Abstract. *The City Bridges project focuses pre-college students on different aspects of design, construction and operation of bridges, and on how they influence urban life while built or ruined. Students are amazed by how many different types of bridges their home town has. Project participants analyze the ways bridges affect urban life, and which reasons conditioned building particular bridges. Physics behind the bridges is basic and first-rate: from Archimedes' Principle and Archimedes' Law of the Lever to the modern Materials Science. When studying engineering and architectural aspects of bridge structures, hands-on modeling is a powerful educational instrument. Some creative designs, e.g. Leonardo bridge, 'flat arch' bridge, self-blocked paper bridges are successfully practiced. International co-operation in the City Bridges project is welcome.*

Keywords. multi-disciplinary projects, hands-on modeling, Archimedes' Law of the Lever

1. Introduction

Bridges, possibly the oldest structures ever built by men, remain the most common objects nowadays, and will be in equal need in the future. Spanning river rapids or sea streams they much more than simply join the banks: *bridges connect people*. Their construction itself requires creative co-operation of a variety of experts. In this sense bridges literally merge sciences with other sciences and with arts. While built, bridges often become an inspiration for artists, poets, musicians. Even for mathematicians: the famous

The Seven Bridges of Königsberg problem resolved by Leonhard Euler laid the foundations of graph theory and topology.

Model bridge building contests are rather popular among the pre-college students, especially in the USA [1, 2]. Balsa wood, Popsicle (ice cream) sticks, safety matches, toothpicks and even spaghetti are among the common materials for that sort of models. Design, construction and tests of miniature bridges is a basic project of the US summer academic programs, like *JHU CTY/CAA* (course of *Principles of Engineering Design*) [3]. Computer modelling of bridges is also a popular educational activity [2].

Our educational *The City Bridges Project* provides for a variety of exciting multi-disciplinary studies and hands-on activities centred on bridge structures.

2. A surprising multitude of bridges

The city of Kharkiv, Ukraine is never mentioned to match Venice and Amsterdam in the number and beauty of bridges. Neither the local rivers can rival Danube or Thames. The more so students working on the project were impressed to discover in the city a broad variety of bridge designs, including the fancy pedestrian ones, and even a working pontoon bridge.

It is a commonplace that the first bridges were just trees thrown across the river by a thunderstorm. Step next was a log masterly put by the ancient humans over a stream. Both designs could be still found on the rivers nowadays. In their slightly updated version s boards, pipes and used doors substitute the traditional logs. Students created an impressive database of pictures and videos of the self-made bridges built by creative population in need to cross over the city streams, rivers and puddles.

On the field trips students watched and photographed professionally constructed bridges, remains of the derelict old bridge structures.

Visiting on-line maps of Kharkiv and other cities, working with literature, project participants analyzed what conditioned building so many bridges and how they affected urban life.

3. Over the urban ‘streams’

Succeeding in linking the shores of the natural streams, mankind produced new flows often hard to cross. Look at the rush-hour city traffic, no less turbulent than the stormy waters. Add the

streetcars (trams) and don't forget the railroads. For those ‘artificial rivers’, so numerous in the modern city, and even for some busy pedestrian areas the best solution is to build some sort of a bridge. Roadways, viaducts, footbridges, you name it. Students participating in *The City Bridges Project* noticed that even water (and other liquids) captured into a pipe may require bridges to walk over, see Fig. 1.



Figure 1. A bridge over the Kharkiv city pipeline.

Road bridges are especially impressive when they solve multi-level interchanges on modern highways. Those are yet to be built in Ukraine, so the project field trips were more focused on the railway bridges, including an incredible three-level old structure.

4. Destined to become landmarks

The very location of a bridge over a strip of water implies for its advantageous viewing position. No wonder many of the city bridges were built to become the outstanding landmarks. Even less ambitious projects constructed in Kharkiv are stylishly designed and decorated with towers, columns, sculptures and plaques. Railings are also often quite picturesque. Some nighttime illumination, flags and banners compliment the views. Modern contribution from the graffiti painters and fancy ‘love padlocks’ attached to the bridge railings should be mentioned.

5. Creative modelling

Important engineering aspects of the bridges’ design, traditional types of bridges (beam, truss, arch, and suspension bridges), their principal elements, typical materials and loads acting on bridges are well presented in educational

publications, e.g. [4].

The project, though, provided for building the less common types of bridges chosen to develop students' creativity. Two designs, undisputable students' favourites, are presented below.

5.1. Leonardo bridges



Figure 2. Leonardo bridge, original design. Photo courtesy Igor Reva

An ingenious design of an arch bridge suggested by Leonardo da Vinci back in 1483 (Fig. 2) still excites teachers and students quite a lot.



Figure 3. A 60-cm Leonardo bridge assembled in downtown Kosice

An on-going project of Czech school students on Leonardo Bridges lead by their teacher Kateřina Lipertová (Církevní gymnázium, Plzeň) [5] is a wonderful success. Some of the giant structures built by the students may support up to a half-dozen of kids [6]. During the outdoors Physics Festivals a variety of Leonardo Bridges are erected in Pilzen, Czech Republic, to the enjoyment of all the participants and visitors. Contributing to this funny and instructive

activity, authors constructed a smaller version of Leonardo Bridge from 20-cm wooden rulers in Kosice city downtown (Fig. 3).

Computer animation of the 'minimal' 8-member Leonardo Bridge's transformations was performed in Excel due to the macros designed by the Kharkiv college students, screenshot presented in Fig. 4. Dependence of the bridge's height upon the position of transverse boards is plotted in the insert.

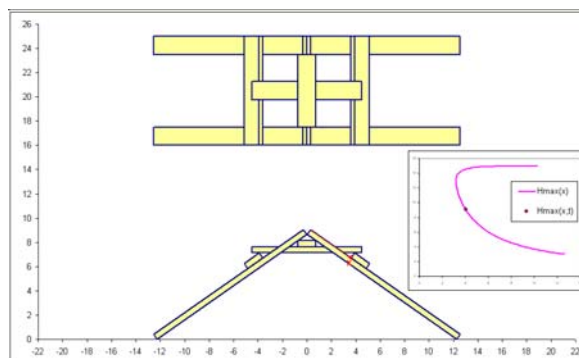

Figure 4. Transformation of the 'minimal' Leonardo Bridge, computer animation

5.2. Four-board permanent bridge

In a book of advanced experimental high school problems [7] a kid and an adult cross the river by building a temporary bridge from two boards each a little shorter than the distance needed to span, Fig. 5. A nice application of the Archimedes' Law of the Lever. Quantitative version of the problem was practiced to determine minimum lengths of the boards required to build the reliable bridge of that type, with the known river width and masses of both persons. Account of the boards' mass is another challenge for the students. Calculations were checked and proved by the corresponding experiments.

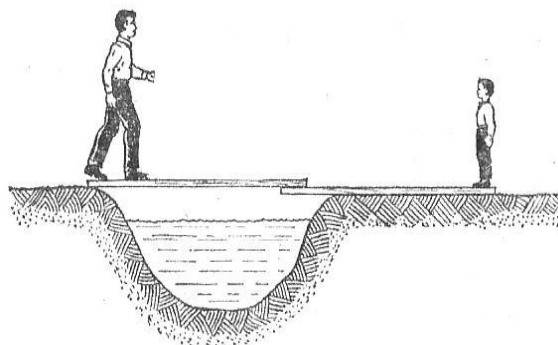

Figure 5. Bridging the river with two shorter boards [7]

A natural way to develop the problem was find the design of a permanent bridge of overlapping boards that requires no counterbalancing. A neat solution was suggested given four boards are available, all shorter than the river's width, see Fig. 6.

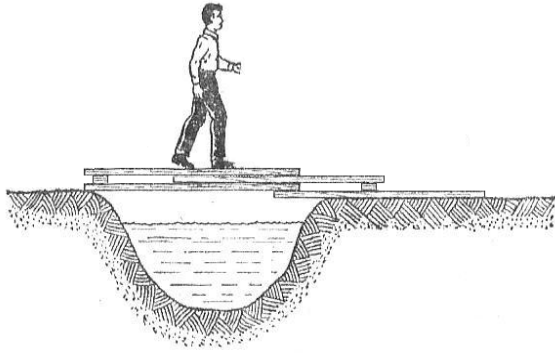

Figure 6. A permanent four-board bridge

Diverse calculations [8] proved in particular, that the length of (equal) boards in this bridge should exceed $\frac{3}{4}$ of the river width.

Unequal boards may also be used, with the corresponding length limitations.

Interesting case of the four-board bridges stable only under load was considered in the project.

6. Conclusive remarks

The well-pronounced multi-disciplinary character of *The City Bridges Project* provides for the interest from the diversely focused students. It is highly challenging for the instructing teachers to arrange students' exchange of expertise and achievements in the course of the project.

International co-operation is strongly welcome.

7. Acknowledgements

This work is the result of the project implementation: Research and Education at UPJŠ – Heading towards Excellent European Universities, ITMS project code: 26110230056, supported by the Operational Program Education funded by the European Social Fund (ESF).

8. References and Notes

- [1] Bridge Building Contest <http://bridgecontest.phys.iit.edu/> [visited 18-May-2013]
- [2] West Point Bridge Design Contest

<http://bridgecontest.usma.edu/> [visited 19-May-2013]

- [3] The Johns Hopkins University Center for Talented Youth Summer Program <http://cty.jhu.edu/> [visited 15-May-2013]
- [4] Karsnitz J, O'Brien S, Hutchinson J. *Engineering Design*. NY: Delmar, Cengage Learning; 2009.
- [5] Lipertová K. Leonardův samonosný most.. In: Dvorak L, editor. *Proceedings of the Heureka Workshops*; 2008. Praha: Prometheus; 2008. p. 41-49.
- [6] Leonardo's Bridge <http://www.youtube.com/watch?v=ivhDiIadRcg&list=UUydqRwCI57t6fsv6IyoR5JQ> [visited 16-May-2013]
- [7] Ланге В. Экспериментальные физические задачи на смекалку. Москва: Наука; 1974.
- [8] To be published.



TEACHING RENEWABLE ENERGY SOURCES BY INQUIRED BASED METHODS

Elena Vladescu

National Vocational College "Nicolae Titulescu"

elenavladescu@yahoo.com

Abstract. *In my school run a Comenius multilateral project 2009-2011, "Renewable Energy Sources – Friends of the Environment". In this paper I will present teaching Renewable Energy Sources by Inquired Based Methods in the framework of this project.*

Keywords. Comenius, Renewable Energy Sources

1. Introduction

Starting with 2009, in my school run a Comenius multilateral project, "Renewable Energy Sources – Friends of the Environment". Partners were schools from Romania, France, Italy, Poland and Bulgaria. The project run with the financial support of the European Commission. The schools worked and cooperated when studying the renewable energy sources. The project working language was English. The project products were presented in the schools'

magazines, CDs and a website. The pupils worked out a multilingual glossary of energy. They also drew regional maps with locations and opportunities for creating alternative energy sources on each country's territory.

In this paper I will present teaching Renewable Energy Sources by Inquired Based Methods in the framework of this project.

2. Objectives of the Partnership

The main objectives of the project were:

- A. Acquiring knowledge and developing skills for preservation of the environment by studying and learning about the basic alternative energy sources.
- B. Working together with European schools on technical documentation in the English language, connected with the study of:
 - Technical parameters of the systems for production and realization of energy (wind, water, sun, etc.)
 - Technology of operation of the energy systems
 - Opportunities for creating alternative energy sources on the territory of the country (a map of the location of these sources)
 - Comparative study of the alternative and traditional energy sources and their impact on the environment
 - Comparative study of the possible alternative sources in the countries participating in the project
 - Analysis of the economic effectiveness of the various energy sources
- C. Increasing the level of pupils' knowledge and the quality of teaching and learning
- D. Promoting the language learning while studying technical documents, communicating with coevals during project meetings, using the Internet, e-mail, communication websites.
- E. Getting to know other countries' traditions and culture and their achievements in using alternative energy sources. is energy generated from natural resources such as sunlight, wind, rain, tides, and geothermal heat, which are renewable (naturally replenished).

3. Distribution of Tasks

The role of each school was described in details after the formation of the working teams and the tasks were divided according to the schools' resources and competences.

Communication between schools was maintained via Internet tools (e-mail; communicators; chat; forums).

A Comenius File was made, which included the project diary and reports on the project meetings. Pupils shared electronic documents made by them at each partner school.

The final products to be made were: brochures which can be shared after international meetings and by mails; CDs; a website; a Handbook.

Project meetings were planned at each partner school, and they were arranged according to the partners' needs and interests.

4. How was used Inquiry-Based Learning in this Project?

In this project, students were involved in all steps (planning, implementation and evaluation) and they acted as researchers in Science. There were formed teams of pupils to study and learn about the basic alternative energy sources. We tried to develop students' ability to plan investigations, develop hypothesis, distinguish alternatives, searching for information, constructing models and debating with peers. We used different types of inquiry activities, from interactive demonstration to open inquiry.

Source	Annual potential (theoretical)	Application
Solar Energy	60 PJ 1,2 TWh	Thermic Energy Electrical Energy
Wind Energy	23 TWh	Electrical Energy
Hydroelectric Energy (below 10 MW)	36 TWh 3,6 TWh	Electrical Energy
Biomass and Biogas	318 PJ	Thermic Energy Electrical Energy
Geothermal Energy	7 PJ	Thermic Energy

After the study of technical, technological and economic literature about the alternative energy

sources, students worked out a multilingual glossary of vocabulary connected with the alternative energy sources. Also the international teams created comparative charts and tables about the technical parameters and the economic effectiveness of the various sources and made regional maps of the location of alternative energy sources (already existing ones and new possible sites). Each school team presented its work during the project reunions.

RES theoretical potential for Romania[1] is represented in the table below (Romanian Energetic Strategy for 2007-2020):

The map of available RES per regions is[2]:

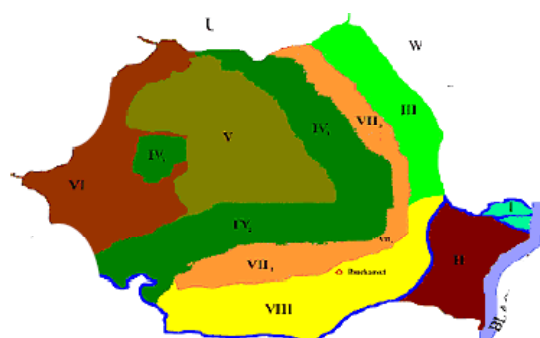

Figure 1. Map of available RES per regions

Legend:

- I. Danube Delta (Solar Energy);
- II. Dobrogea (Solar and Wind Energy);
- III. Moldova (Micro-hydro, Biomass and Wind Energy);
- IV. Carpathian Mountains (IV1 – Eastern Carpathian; IV2 – Southern Carpathian; IV3 – Western Carpathian (Micro-hydro and Biomass));
- V. Transylvanian Plateau (Micro-hydro);
- VI. Western Plain (Geothermal Energy);
- VII. Subcarpații (VII1 – Subcarpații Getici; VII2 – Subcarpații de Curbură; VII3 – Subcarpații Moldovei: Micro-hydro and Biomass);
- VIII. Romanian Plain (Biomass, Solar Energy and Geothermal Energy).

5. Science Fair

During the project reunion who took place in our school, we organized a Science Fair with experimental devices made by Romanian students in the frame of this project. The success

of this Science Fair was huge. Students presented many experiments, experimental devices made by themselves and real-life applications of Science. All illustrated the theme of the project – renewable energy sources and their impact on the environment.

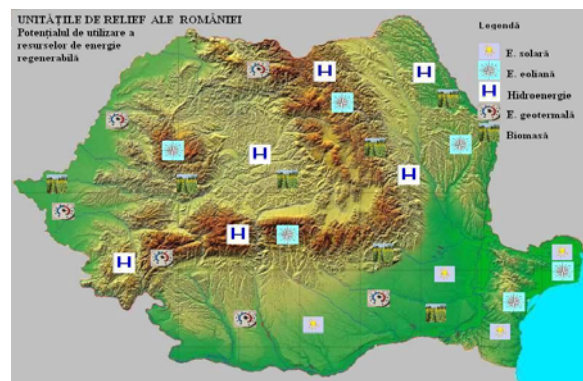

Figure 2. Map of available RES per relief units

During the preparation and the presentation of their experiments, students gained a deeper understanding of the phenomena in the IBSE approach and will probably remember the “new” knowledge longer through the process of internalization[3]. Inquiry based skills developed in this Science Fair were amongst others:

- Planning and conducting investigations;
- Gathering data;
- Performing experiments;
- Analyzing results obtained with experiments;
- Communicating results with the use of graphs;
- Using results from one experiment to analyze the results of another experiment;
- Using knowledge from one field in another field.

In some activities the computer was used to record sound and to analyse the data.

6. The Impact of IBSE and of this Partnership

Students, teachers and parents were very interested in using IBSE methods for the study of renewable energy sources. We believe that the impact was very significant on the participants.

On Pupils:

- development of skills for diagnosing problems, critical thinking, planning investigations, researching

- alternatives[4];
- development of skills for group work, argumentation, dialogue, debate, exploration and experimentation;
- training in problem analysis and solving;
- a deeper feeling of being a members of a wider Community, the European one, and a stronger sense of respect and tolerance toward other cultures;
- a deeper spirit of cooperation and friendship
- higher competences in foreign languages and new technologies which are so necessary today;
- a deeper feeling that they contribute to the improvement of the environment;
- development of sense of responsibility;
- knowledge of other cultures;
- a more active citizenship;
- a wider cultural background.



Figure 3. *Science Fair in our school*

On Teachers:

- development of skills for IBSE oriented teaching;
- development of skills for teamwork and cooperation with teachers from other countries
- exchange of experience and teaching methods in order to improve the quality of education and work out “good practices”
- formation of skills for organizing the work
- be encouraged to find new and imaginative ways in the implementation of the syllabus through this project, (the teachers in particular)
- improvement of language competences in English and in the partners’ mother

languages from the point of view of a lifelong learning

On Institutes:

- More contacts and cooperation among the participating schools
- A higher flexibility towards different education plans
- A closer approach towards the local community and a better understanding of its education needs
- More opportunities to work out education plans which are closer to the needs of the local community

On Local communities:

- a wider opening towards Europe and its different cultures
- Cultural enrichment through the mutual knowledge realized through the dissemination of contents and activities of the project on the Internet, on the schools’ websites and on the town councils’ websites, on local newspapers and in local TV programmes
- A higher sensibility to environmental problems and to an eco-sustainable development
- Opening to the possibility of new and better jobs, respectful of the environment, for the future generations

On education communities:

- the project will be a stimulus to other schools to start European collaborations

7. Conclusion

I conclude that Inquired Based Method is very good to teach the renewable energy sources.

The results from the project activities were included in the theoretical and practical training at the school: there were an incorporation into the syllabus of geography classes (opportunities for creating alternative energy sources on the territory of the country (a map of the location of these sources), technical English classes (working out a multilingual glossary of vocabulary connected with the alternative energy sources), computer science classes (preparing Power Point presentations and electronic documents about RES), economics classes (analysis of the economic effectiveness of the various energy sources), chemistry and preservation of the environment classes,

vocational subjects classes (study of technical parameters of the systems for production and realization of energy). Still, there is a long way until the IBSE to become a main approach for teaching Science in our countries. It all depends on national curriculum content, assesment criteria, resources and teachers training.

Anyway, this project was a great opportunity for students, teachers and local communities from five countries to work together on renewable energy sources theme.

8. References

- [1] Final Report, Strategy on Renewable Energy Sources in Romania, EC - DG I PHARE Program, 1995
- [2] International Energy Agency (IEA), "Romania," 2009
- [3] <http://res-comenius.webnode.com/>
- [4] <http://www.establish-fp7.eu/>



TEACHING MATHEMATICS THROUGH IBSE METHODS

Lucian Constantin Vladescu

Scoala Gimnaziala Ipotesti, Olt, Romania
luconstvl@yahoo.com

Abstract. *In this paper I will exemplify the IBSE method of teaching mathematics for the lesson "Integers". I participated in the training course "Intel Teach-Training in the Knowledge Based Society." This course helped me to make my lessons more attractive by integrating resources and IT tools in teaching mathematics. In my opinion, we have to work together for a continuous improvement of Romanian education system and to create equal conditions for all children, whether they are living in the countryside or in the city, because European integration depends largely on education, culture and science.*

Keywords. AEL, IntelTeach, Mathematics, IBSE

1. Introduction

In this unit, students learn the concepts of:

- Integer, opposite
- Comparing and ordering integers
- Operations with integers
- Rules for calculating with powers
- using the order of operations and parentheses
- Solving equations in Z
- Solving inequality in Z .

Essential Question:

- How math helps us in solving practical content?

Unit Questions:

- Why we need to know the concept of integer?
- How help us use these concepts in problem solving?

Content Questions:

- How do we define an integer?
- What is the opposite of an integer?
- How it compares and how orders are integers?
- What are the operations with integers?
- What is the order of operations in Z ?
- How to solve problems that arise in operations with integers?
- How to calculate the power of an integer?
- What are the rules of computing powers?
- How to solve equations and inequalities in Z ?

Students will participate in solving individual and group applications, the degree of difficulty gradually differentiated learning styles and level of understanding focused on:

- Identification of issues involved;
- Find real-life problems solved with integers, the development of the graphical representation;
- Identify problem situations, which can be transcribed into mathematical language, using algebraic calculations to determine an unknown in an equation in Z .

2. Unit's Objectives

1. Use algebra to simplify computing elements calculations and for solving equations.
2. Identify-problem situations, to transpose them into mathematical language and

- effectively organize how to solve them.
3. Build problems, based on a model (graph or formula).
 4. Consistently provide the solution to a problem, using various modes of expression (words, mathematical symbols, diagrams, tables, various construction materials).
 5. Identify uses of mathematical concepts and methods studied in solving practical problems.
 6. To assume different roles within a learning group, arguing ideas and mathematical methods, using different sources of information to verify and support opinions.

3. Operational Objectives

Students will be able to:

- To understand what an integer is;
- Solve problems that arise in operations with integers;
- To calculate the power of an integer;
- To solve equations and inequalities in Z.

4. Didactical Strategy

First hour:

To achieve the unit's portfolio, students must have theoretical knowledge on the concepts from this unit. Will divide students into three groups and will complete homogeneous KWL chart. Students seek information about the concept of individual integer which it saves in a folder "Resources". It uses brainstorming method. They note the integer's definition. Students will continue to search for information about the concept of opposite integers, comparing and ordering integers. For each concept will write the definition. Students in each group will be asked to complete their work schedule which will include exercises with a degree of difficulty gradually differentiated for each group. Within each group, students can work individually by distributing the task. Each group will post on the forum worksheet to get an overview and to view and work groups and other forums will complete a checklist on progress. This activity begins in the classroom and will be continued at home. The teacher will continuously observe and work groups will help students when

difficulties.
 Examples:

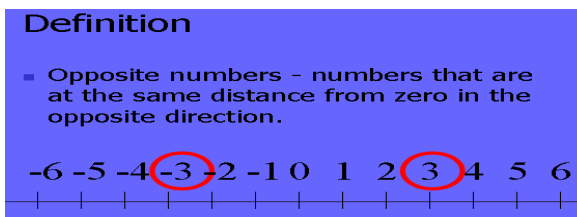

Figure 1. Opposite numbers definition

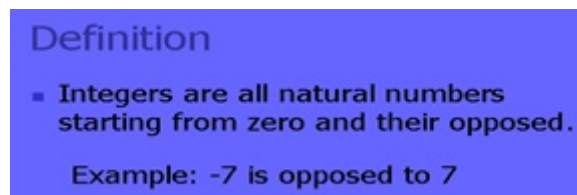

Figure 2. Integer's definition

Second hour:

Students collect information about addition and subtraction of integers. Using examples, students will solve such operations. Students will be divided into three groups and they will publish the results of their work in the forum.

Examples:

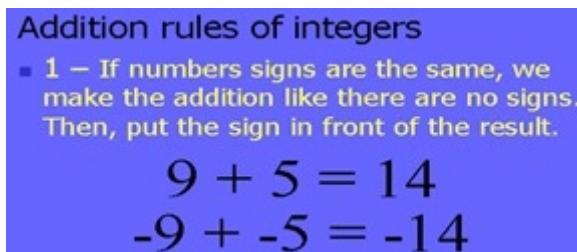

Figure 3. Integer's addition rule 1

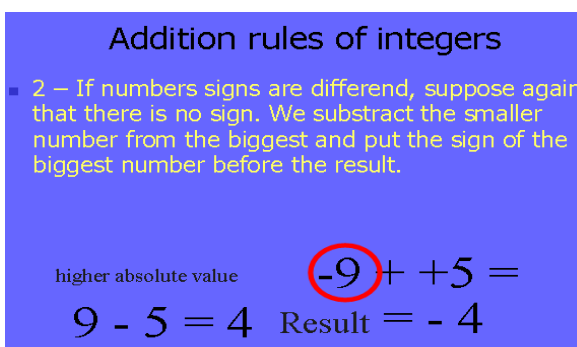

Figure 4. Integer's addition rule 2

Third hour:

It collected information on multiplication and division with integers. Students will be divided into three groups and the forum will

publish results of their work.

Fourth hour:

It collected information about the power of an integer exponent and the natural rules of computing power. Using examples, students solve exercises. Students will be divided into three groups and the forum will publish results of their work.

Fifth hour:

It collected information on equations and inequalities in Z . Using examples, students solve exercises such operations. Students will be divided into three groups and the forum will publish results of their work.

Sixth hour:

Presentation of the final products of groups, carry out evaluation / self-presented product. After the presentation, teacher discuss with his students in order to analyze the extent to which students have acquired knowledge and developed skills of collaboration, communication, creativity.

5. Evaluation

Students will fill in a KWL chart to identify knowledge needs of students. The teacher will ask students to write in the first column what they know about integers and the second what they want to know about it and in the third – what they learned. Students will be divided into groups according to their level of understanding, will work differently from completing worksheets developed by teacher and will complete lists of progress. To communicate, exchange views or improving certain content, to view products, it will be used discussion method and the forum.

Analyzing portfolios will be as follows:

- Presentation - the key criteria for presentation
- Students will complete the table-I know I want to know - I learned to appreciate progress.
- Each student will complete a feedback form on the forum for his colleagues' presentations.
- Each student will be assessed with a mark.

I used initial assessment, formative assessment and summative evaluation.

Negative numbers are used to measure, especially in winter temperatures.

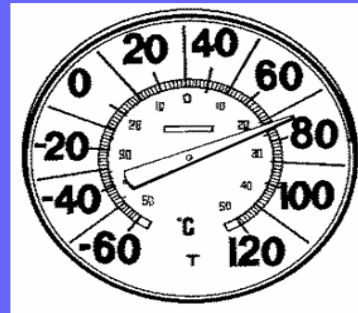

Figure 5. First application

6. Conclusions

I noticed that students are very attracted to this type of learning, though things started hard, students of rural environment had not benefited from the advantages of urban students. KWL chart (I know, I want to know, I learned) has been a very effective tool and highly appreciated by students. They have learned to express ideas, knowledge, to discuss, collaborate in teams, something new for them. It was difficult initially to make them think by themselves, take initiative and to express ideas using brainstorming method. To explain the concept of integer, I use many applications and examples from real life, because only this way I managed to attract their attention and make them understand.

I concluded that only if you consistently apply this method at least over a full cycle of four years, results can be achieved with the students.

Examples:

Negative numbers are used to measure depth below sea level.

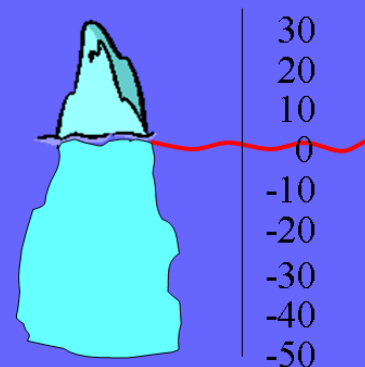

Figure 6. Second application

7. References

- [1] <http://www.didactic.ro/index.php?cid=cautar&action=search&words=Numere+intregi&cat=10&cls%5B6%5D=true&disciplina=0> [03/27/2010]
- [2] Textbook course Intelteach
- [3] Textbook for grade VI-th, Dana Radu, Eugen Radu-Editura Teora.



INQUIRY BASED SCIENCE EDUCATION – APPLICATION IN CHEMISTRY

**Hana Čtrnáctová, Monika Petriláková,
Veronika Zámečnicková**

Charles University in Prague, Faculty of Science, Department of Chemical Education, Czech Republic

hana.ctrnactova@natur.cuni.cz,

mpetrilakova@goachodov.cz

veronika.zamecnikova@omska.cz

Abstract. *Science, which plays an irreplaceable part in life of every human, should be among educational subjects the students understand well. However, both practice and research prove that this is not so. IBSE suggests itself as one possibility of resolving these problems and improving science education.*

This contribution starts by short characterization of IBSE and sketching its main aspects. It shows the overview of important projects about this method and it characterizes the IBSE situation in Czech Republic. It also delineates themes in chemistry education at primary and secondary schools that are suitable for the application of this method and shows the model activities from the field of chemistry at secondary schools.

Keywords. Primary and secondary schools, teaching and learning innovative methods, inquiry based science education, inquiry based chemical education

1. Introduction

In recent years a number of international studies have been implemented monitoring both

knowledge and skills of students/pupils, and also their interest in science subjects. It is apparent that the scientific knowledge that students have are at good level; a major problem is the explanation of phenomena, understanding the laws of nature, abstract concepts and explanations of the attitudes [9,16]. Students/pupils have problems mainly with the creation and formulation of hypotheses, using research methods, with experimental activities and interpretation of data. The reality is also a decreasing students' interest in science subjects.

A similar situation prevails not only in the Czech Republic but also in other countries of the European Union. Therefore, in 2007, an EU study was published, which recommends the innovation of the content and application of new methods of teaching in science subjects, especially those that use inquiry based approach [12]. Such a method is particularly the method of inquiry based science education (IBSE). The results of recent research confirm that this method is effective in increasing students' interest in science subjects, motivates both students/pupils and teachers and brings a deeper understanding of curriculum of these subjects and thereby a deeper understanding of natural sciences [5].

2. Inquiry Based Science Education

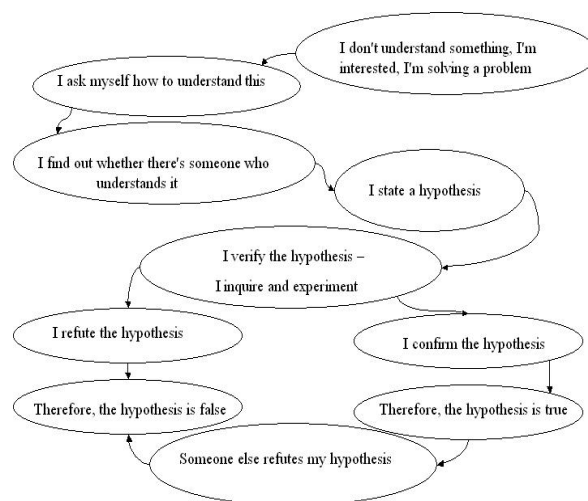

Figure 1. Vědecký postup [13]

The essence of the method of inquiry based science education is the exploration of students themselves, acquisition of knowledge and skills through problem-solving. This method provides students/pupils with the ability to formulate questions, gather information and integrate them

into a meaningful context, propose both the solutions to the problem and a working procedure, discuss findings, and actively acquire the necessary knowledge and skills. This method of teaching is to simulate the scientific procedure (see Fig 1). The teacher does not pass the curriculum to students/pupils through interpretation, but he/she rather plays here a role of a coordinator of students/pupils, which helps to achieve the desired objectives. He/she encourages students/pupils to know how to search for information, assess their relevance, choose those that are necessary to solve the task and how to use the information so acquired to solve the problems.

However it would be mistaken to assume that students/pupils will be able from the beginning to do scientific research independently.

In terms of teacher's assistance, IBSE can be divided into four levels, which allow the involvement of students/pupils according to their evolving capacities [1]

level IBSE	questions (determined by the teacher)	procedure (determined by the teacher)	solution (determined by the teacher)
confirmation	yes	yes	yes
structured	yes	yes	no
guided	yes	no	no
open	no	no	no

Table 1. Four levels IBSE [1]

Confirmation inquiry

Students/pupils are made familiar with the results in advance and they subsequently validate them. They follow the instructions to perform the experiment, record the data, and evaluate the results.

Structured inquiry

The teacher determines the question and procedure; students/pupils explain the results using the evidence gathered.

Guided inquiry

Students/pupils will be given a question, they propose the solution procedure, they practically verify it and explain the acquired data. Apart from the skills to interpret data for mastering of these explorations they need to learn different procedures of how to plan experiments, to record data, etc. The teacher can confirm the meaningfulness of their

plans.

Open inquiry

Students themselves choose a question, create a hypothesis, devise a way of its verification, perform its validation, record data, explain it and generalize.

The proportion of students/pupils and teachers' work in various stages of research work is shown in Table 1.

3. IBSE in the Czech Republic

In the Czech Republic, since 2005, new curricular documents have been introduced into schools; these documents in their general part proclaim to develop the skills and competencies of students/pupils, but in practice they virtually do not bring any changes. However, the importance of IBSE method is here realized by more and more didactic specialist and teachers. Czech agencies approve the projects focused on this method such as 3V, Researchers, Generation Y, Science is no science, etc. The Czech Republic is involved in EU projects addressing this issue (POLLEN, PROFILES, S-TEAM, ESTABLISH, etc.) These projects aim to provide quality education in science subjects, within which educational and methodological materials are created using IBSE for both the students and their teachers. Courses and seminars are organized for teachers; these help the teachers to understand new trends in science subjects teaching and facilitate the implementation of IBSE in teaching. An overview of the most important projects currently solved in the Czech Republic with a focus on IBSE is stated e.g. in the publication of Nedomová [7].

In the field of natural sciences, the highest number of studies is now devoted to IBSE as a tool for teaching of biology and ecology. They e.g. process the aspects of this method, issues related to its implementation in schools and they also offer specific tasks for teaching of biology and ecology (Papáček [10] Stuchlíková [15], Nikrýnová [8]). Other science subjects such as chemistry and physics are also gradually involved in these studies.

4. Selection of chemistry curriculum content for IBSE

Tasks for chemistry inquiry based education have not been yet developed in greater extent. In

addition to the above projects, only a few doctoral theses are currently devoted to this area. This lack can be explained by the concern with processing of difficult topics in chemistry teaching and also by quite strict safety rules in a chemical laboratory. However, if our intention is to make science subjects more attractive for students/pupils, should not be solving of chemical tasks just the right challenge? Finally it is necessary to overcome an antipathy to hours of chemistry and decline of interest in this field of study. The selection of topics for IBSE in chemistry should therefore be a motivation for all who create textbooks for students/pupils, textbooks for teachers, tasks for both teachers' demonstrations and experiments for students.

A selection of curriculum content for inquiry based education can be the selection of the didactic content of the educational course, i.e. from both framework educational programs and school educational programs and also from existing textbooks. However, it can also be a selection beyond the content of textbooks, especially in the case of teaching undertaken as project days, etc. Generally speaking, the choice of curriculum for IBSE may be subject to substantive and syntactic topic content and to characteristics important for IBSE such as dynamics of knowledge development, a story and an action. Other important moments of choice are critical assessment of the topic in respect of educational objectives and verification of effectiveness in teaching process after the topic taught by IBSE method has been applied in a real lesson [10].

5. Limits to IBSE implementation in schools

A decline in student interest in science subjects has previously led to the formation of activation teaching methods. IBSE elements are included in educational approaches such as problem learning, project based learning, collaborative teaching, activation teaching, experiential learning. Vališová also defines one of the methods of practical student activities similar to IBSE: Laboratory work of heuristic nature allows students/pupils to discover for themselves, through problem solving tasks, new facts, relationships, to experiment and search and then acquire new knowledge [19].

Therefore the conclusion can be arrived at that various forms of activation teaching where the main role is primarily attributed to the

student/pupil have already been here earlier. However, a fundamental change in the teaching process has not appeared in practice. So why teaching of problem-solving tasks, projects, and other forms of active learning have not been previously applied in a larger extent? Where can teachers see the complications in the implementation of activation methods into teaching?

IBSE advantages are after all obvious, and we can summarize their main points as follows:

Advantages of IBSE:

- Initiative of students/pupils through observation, devising of processes, measurements, analysis of results
- Improved capabilities and skills necessary to work with information
- Development of creative thinking of student/pupil
- Easier to understand the outside world, nature
- Interest in the above issues

However, limits to IBSE implementation into teaching should be discussed in somewhat broader context.

As seen by the teachers, the main difficulties in implementing of IBSE into schools are the lack of time, teachers are afraid of not meeting the established school programs. However, current curricula introduced in schools offer more space both for creativity of teachers and also for lesson planning. It is up to the teacher whether a given topic will be acquired by students/pupils using IBSE or traditional frontal teaching. Of course, with frontal teaching, much more of the curriculum can be managed, but the question is whether the students/pupils will acquire the curriculum really in a long time horizon or they will only remember it for a short time. Moreover, facts are also in today's world easily accessible; therefore a valuable skill is rather to understand the information than to memorise it [11].

In addition, teachers fear that they do not have sufficiently equipped classrooms and laboratories, or sufficient funds to implement this method. There is certainly nothing to worry about, now there are tasks that are not at all demanding in terms of tools or chemicals.

Another risk is insufficiently trained and prepared teacher to run IBSE. An essential fact in this respect is that in the Czech Republic there have not yet been many studies devoted to IBSE more theoretically with the aim to bring it closer

to professional public, the concept of IBSE has not been fully defined and neither has its functional content. Similarly, unlike the situation in the USA and Western Europe, in the Czech Republic there are not available textbooks and methodological manuals dealing with constructivist concept of teaching and IBSE in natural sciences for student teachers and novice or experienced teachers in practice [11].

As a step forward, it is therefore education of chemistry teachers through workshops, where they can watch or try a ready demonstration of IBSE in the role students/pupils, further they can obtain procedures for already created tasks and finally they can acquire the IBSE method and its practical applications.

6. IBSE in chemistry

Suitable topics taught using the IBSE method in general chemistry curriculum are e.g. topic areas such as substances, mixtures, acids and alkali, metal reactivity, redox processes, etc. For inorganic chemistry, teaching tasks are created for individual elements, or for groups of elements and their compounds, especially with regard to their practical application in everyday life. Topics difficult to understand such as the structure of organic compounds and their isometrics have been selected for IBSE method in organic chemistry. Furthermore, this area is also devoted to reactivity of alkanes and alkenes, alcohols, carbonyl compounds, carboxylic acids, and other topics.

To illustrate this, there is an example of task Solubility adjusted for the level of guided inquiry at secondary school.

In the introduction to the task, students/pupils inquire the relevant information available (answer the questions: What is solubility? What is a solvent? What is a dissolving substance? What is a mixture? What is the difference between homogeneous and heterogeneous mixtures?). Furthermore they draw a mind map on the topic Mixture. This activity is introduced by the teacher using the questions: Where can you find a mixture and which examples of mixtures come to your mind? What have you known about mixtures?

Then, through the game, the students/pupils are presented with a problem: What is a saturated solution? Students/pupils discuss in groups and try to define the concept. They design an experiment, which may confirm their hypothesis and defend their definition. They are helped by

the tools that are available, diagrams and pictures (see Fig 2, Table 2, and Table 3).

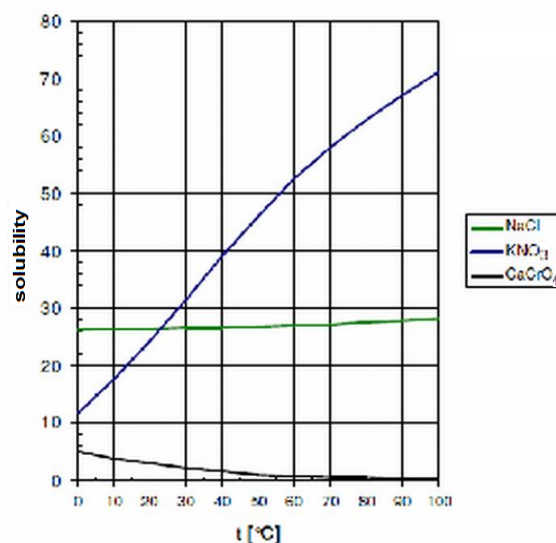

Figure2. Solubility curves of NaCl, KNO₃ and CaCrO₄ [14]

Students record the results of experiments, and finally discuss the relevance and provability of their approach, because with the experiment the actual execution is not the only important task, but the correct interpretation of the results is also necessary. The teacher guides them through their work by leading questions, but he/she does not confirm or disprove the direction of research. Students/pupils themselves derive the concept of saturated solution and are able to further use it. It is clear that in this way the acquired concept will be more permanently stored in the memory and understanding of its principles may also help in learning. The task can be supplemented with the issues of factors affecting solubility (influence of solvent, dissolved substances, presence of other substances in the solution, temperature, pressure), further the properties can be illustrated of dissolved substance and solvent (in terms of polarity loop), etc.

6. Conclusion

In this article we have tried to summarize the most important aspects of the IBSE method, to highlight its importance and the reasons why we pay attention to it. Despite some problematic aspects of this method, we see its great potential which can help students to deepen their acquired knowledge and skills and to understand the principles of chemical structures, phenomena and processes. Last but not least, we hope that

teaching by IBSE will motivate students to study science subjects, or at least raise their interest in natural phenomena with which they encounter in life. Using simple experiments with students/pupils will also encourage their ability to think critically, act logically and verify information and its sources, all of which are the skills necessary for contemporary life.

°C	NaCl	NaNO ₃	KCl	K ₂ SO ₄	AgNO ₃	KNO ₃	CaCrO ₄
0	26,28	42,2	22,2	6,87	53,5	11,6	5,0
10	26,32	44,6	23,8	8,47	61,5	17,7	3,8
20	26,39	46,8	25,5	10,03	68,3	24,1	3,0
30	26,51	49,0	27,2	11,49	73,8	31,5	2,2
40	26,68	51,2	28,7	13,1	77,0	39,1	1,6
50	26,86	53,3	30,1	14,2	80,0	46,2	1,1
60	27,07	55,5	31,3	15,4	82,5	52,5	0,9
70	27,30	57,6	32,6	16,6	84,6	58,0	0,7
80	27,55	59,7	33,8	17,6	86,7	62,8	0,6
90	27,81	61,7	34,9	18,6	88,4	67,1	0,5
100	28,15	63,5	36,0	19,4	90,1	71,1	0,5

Table2. Solubility of substances depending on temperature (number of g substance per 100 g solution) [14]

Látka	x	Látka	x
ZnCl ₂	78,5	KNO ₃	24,1
AgNO ₃	68,3	Na ₂ SO ₄	16,1
K ₂ CO ₃	52,8	K ₂ SO ₄	10,03
FeCl ₃	47,9	KMnO ₄	6,0
NaNO ₃	46,8	KClO ₄	1,7
CaCl ₂	42,7	PbCl ₂	1,0
CuCl ₂	42,2	Ag ₂ SO ₄	0,77
NH ₄ Cl	27,1	CaSO ₄	0,203
Al ₂ (SO ₄) ₃	26,6	CaCO ₃	1,4•10 ⁻³
NaCl	26,39	BaSO ₄	2,3•10 ⁻⁴
BaCl ₂	26,3	AgCl	1,7•10 ⁻⁴
KCl	25,5	AgI	2,3•10 ⁻⁷

Table3. Solubility of some inorganic substances (x-number of grams of substance in 100 g of saturated solution at 20 ° C) [14] (Látka = Substance)

7. References

- [1] Banchi H, Bell R. The Many LevelsofInquiry. Science and Children, Vol. 46(2), 2008. p. 26-29.
- [2] Bílek M. Zájem žáků o přírodní vědy jako předmět výzkumných studií a problem aplikace jejich výsledků pedagogické praxi. Acta Didactica, 2008. p. 1-5.
- [3] Held L, Žoldošová K, Orolínová M, Juricová I, Kotuláková K. Výskumne ladená koncepcia prirodovedného vzdelávania (IBSE v slovenskom kontexte). Trnava: Pedagogická fakulta Trnavském Univerzity; 2011.
- [4] Janoušková S, Maršák J. Inovace přírodovědného vzdělávání z evropského pohledu. <http://www.rvp.cz>. [visited 20-March-2013]
- [5] Mayer R. Shouldtherebe a three-strikes rule againstpurediscoverylearning? The case for guided methods of instruction. American Psychologist; 2004. p. 14-19.
- [6] MŠMT. Důvody nezájmu žáků o přírodovědné a technické obory. Výzkumná zpráva http://ipn.msmt.cz/data/uploads/portal/Duvody_nezajmu_zaku_o_PTO.pdf [visited 20-March-2013]
- [7] Nedomová K. Badatelsky orientovaná výuka v přírodních vědách. Praha: Přírodovědecká fakulta Univerzity Karlovy; 2010.
- [8] Nikrýnová A. Badatelské metody ve vzdělávací oblasti Člověk a jeho svět: semena, plody, mladé rostliny. Praha: Pedagogická fakulta Univerzity Karlovy; 2012.
- [9] Palečková J. a kol. Hlavní zjištění výzkumu PISA 2006: Poradí si žáci s přírodními vědami? Praha: ÚIV; 2007.
- [10] Papáček M. Badatelsky orientované přírodovědné vyučování – cesta pro biologické vzdělávání generací Y, Z a alfa? SCIED, 2010. p.33-49
- [11] Papáček M. Limity a šance zavádění badatelsky orientovaného vyučování přírodopisu a biologie v České republice. In: Papáček M, editor. Didaktika biologie v České republice 2010 a badatelsky orientované vyučování; 2010.
- [12] Rocard M, Cesmrely P, Jorde D, Lenzen D, Walberg-Herniksson H, Hemmo V. Science education NOW: A Renewed Pedagogy forthe Future of Europe. European Commission; 2007 http://ec.europa.eu/research/science-society/document_library/pdf_06/report-rocard-on-science-education_en.pdf [visited 20-March-2013]
- [13] Sdružení Tereza. Projekt 3V – vědě a výzkumu vtříc. 2010 <http://www.projekt3v.cz> [visited 20-March-2013]
- [14] Stránský P. Rozpustnost. 2008. <http://www.gvi.cz/index.php?o=1000279> [visited 20-March-2013]
- [15] Stuchlíková I. O badatelsky orientovaném vyučování. In: Papáček M, editor. Didaktika biologie v České republice 2010 a badatelsky orientované vyučování; 2010.
- [16] Tomášek V. a kol. Výzkum TIMSS 2007: Obstojí čeští žáci v mezinárodní konkurenci? Praha: ÚIV; 2008.

- [17] Trnová E, Trna J. Přírodovědně nadaní žáci a IBSE (Science gifted students and IBSE). In: Janda M, Šťáva J. Nadaní žáci ve škole. Brno: Masarykova univerzita Brno; 2011. p. 127-138.
- [18] Vališová A, Kasíková H. Pedagogika pro učitele. Praha: Grada; 2011

Acknowledgements

GACR P407/10/0514 Pupils' skills in biology, geography and chemistry: research on intended, realized and acquired curriculum in curricular reform implementation phase.

Project ESTABLISH (FP7-SCIENCE-IN-SOCIETY-2009-1 Grant Agreement Number 244749).



HANDS-ON SCIENCE COURSE FOR UPPER PRIMARY AND LOWER SECONDARY SCHOOLS IN POLAND – A CHALLENGE FOR USING IBSE METHODOLOGY IN DEVELOPING PRACTICAL AND EXPLORING SKILLS

**Bożena Karawajczyk,
Marek Kwiatkowski**

*University of Gdańsk, Faculty of Chemistry,
Gdańsk, Poland*

*karawana@chem.univ.gda.pl,
kwiatm@chem.univ.gda.pl*

Abstract. *In 2010, the UE project was launched, whose aim was to develop a separate hands-on course for the students of upper primary and lower secondary schools, meant just for the development of practical and exploring skills. The course, called ZPB (the acronym for Polish "Zajęcia Praktyczno-Badawcze"), was first introduced in Elbląg powiat as a pilot study. A total of 96 students' groups from upper primary and lower secondary schools, as well as 24 experienced teachers of science, biology, chemistry and/or physics, took part in this project. The ZPB course is run in accord with Inquiry Based Science Education methodology (IBSE). Every activity starts from introducing the*

problem by the teacher. Then students formulate hypotheses, plan and run experiments that are supposed to verify the hypotheses, analyse the outcome, draw conclusions and present the results of their work to other students. Students work in small groups, thus training the co-operative skills. The questionnaire study run after the pilot first-year cycle of ZPB course at schools has revealed quite positive attitude of all important stakeholders (teachers, students and school authorities) towards the course. In their opinion, the course should be introduced to the national curricula of upper primary and lower secondary schools in Poland.

Keywords. hands-on course, Inquiry Based Science Education methodology, practical and exploring skills

1. Introduction

The new Polish National Curriculum for primary and secondary education [1], introduced in 2009, specifies in detail the scope and content of educating students in so called "natural sciences subjects" (science, biology, chemistry, physics). This document stresses the importance of developing a group of specific skills among the students, that can be jointly termed "practical and exploratory skills". They include (among others):

- scientific thinking – formulating conclusions based on empirical observations of nature and society, using the acquired knowledge to problem identification and solving
- mathematical thinking – using of basic mathematical tools in everyday life, formulating opinions based on mathematical reasoning
- making use of modern information and communications technologies
- searching for, classification and critical analysis of information
- team work.

The recent reports of Polish Central Examination Commission [2] indicate that realization of this important task by schools is far from being satisfactory. Natural science subjects are still generally taught in a traditional way, with passive students listening to a teacher, who is the main source of new knowledge. There are many reasons for this state of affairs. The most important one seems to be a vast range of new content required to be absorbed by the students,

compared to a limited time assigned to natural science subjects in education programmes. The teachers are generally aware about this situation and try to activate students by running chemical demonstrations, showing video clips with chemical experiments, asking questions. Students only occasionally have opportunity to work in groups on specific tasks: most often text analysis, solving exercises, examining and comparing objects. Experiments planned and run by the students themselves are still rather rare in educational practice. As a result, students have very limited opportunity to train their practical and exploratory skills by running experiments, collecting observations, formulating hypothesis, drawing conclusions, etc. This is not conducive to the development of students' creativity, independent thinking or working in groups. For example, the analysis of the results of external competence tests for the graduates of Polish lower secondary schools indicates that "... students still have major difficulties in performing tasks that verify application of knowledge to solving of problems, in appropriate using terms and concepts specific for natural sciences, in describing the cause – effect relations..." [2].

2. The concept of "Practical and exploratory workshops" (ZPB)

The new course "Practical and exploratory workshops" (abbreviated as ZPB from Polish "Zajęcia Praktyczno-Badawcze") is a complex proposition that attempts to address the problems outlined in the short analysis above. This course has been developed as a result of EU project "Practical and exploratory workshops in Elbląg powiat. Pilot programme for implementing a new course to educational programmes of upper primary and lower secondary schools" and still is being under evaluation in selected schools in Northern Poland [3].

The ZPB course is based on the content for natural science subjects outlined in National Curriculum, but its goals are different. While the particular subjects concentrate on knew knowledge, ZPB is aimed first of all on developing practical and exploratory skills. A set of separate educational standards has been developed for the course [4]. They do not refer to any specific content. Instead, they specify particular competences that a student should achieve by completion of ZPB. They include:

- using appropriate terminology in describing observed objects and phenomena
- planning and running observations and measurements
- identification and solving problems
- analyzing data and generalizing
- application of knowledge and science methods in new contexts
- operation of simple instruments and tools

The final choice of standards has been completed on the basis of diagnostic survey conducted in the selected Polish schools. The survey has indicated that the students have major difficulties with integrating the knowledge from science subjects, applying this knowledge in practical situations or solving problems by themselves.

An educational programme for the ZPB course has been developed [5], as well as the textbook for students [6] that contains propositions of students' activities on ZPB classes. The content of the programme conforms the National Curriculum for natural science subjects: Science for upper primary school, and Biology, Chemistry, Physics for lower secondary school. Nevertheless, the programme for the lower secondary schools does not follow the division of science education to separate subjects. Instead, it proposes an integrated approach to learning science at this level, which is new in Polish education system.

ZPB activities are run in accord with Inquiry Based Science Education methodology (IBSE) and they are substantially different from typical classes of natural science subjects. Above all, they are based on students experimenting activity, carried out in small groups. At the beginning of each class, students are introduced to a particular problem by the teacher, who starts from some observation, reported result of an experiment, theoretical reasoning, etc. Students try to identify the problem, postulate hypotheses, try to verify them experimentally, come to conclusions that they present publicly in front of other students. The formula of activities stimulates students' engagement, trains co-operation in groups, makes possible to assign tasks according to individual preferences and aptitudes of students. Even the students that do not perform well on traditional science classes have chance to discover their talents and to get satisfaction from their achievements.

Also teachers play a different role on ZPB activities. They are no longer in a position of a

person who decides about every element of teaching process, who directs, controls and appraises students' actions. Instead, they become rather experts and advisors, moderators who discreetly leads students through the activity and encourage them in their efforts. They do not offer ready solution or systematised explanation, but rather expect the conclusions will be provided by students themselves. They should create the atmosphere that encourages students to pose questions, learn from their errors, look for the relevant information in available sources, or come to individual decisions. They should be open to the individual ways students reach their conclusions, supporting the development of their personality. The ZPB laboratory should become the place, where students are free to observe, to experiment, to explore.

3. Implementing ZPB in selected schools

ZPB has been implemented as a pilot course in five primary schools and five lower secondary schools in Elblag powiat (county), altogether 96 student groups participating in these activities. For the purpose of this course, the schools have been furnished with laboratories, fully equipped in instruments and tools necessary to run the desired experiments.

Teachers for ZPB have been selected based on their practice in teaching natural science subjects (Science, Biology, Chemistry, Physics). Since none of them had any former experience with activities of the ZPB type, they have been trained by the authors of the educational programme. The training included new content for teachers non-specialists in a particular subject (eg. chemistry content for Biology teachers), as well as methodology of ZPB and organizational aspects of this course.

Educational Internet platform [7], created particularly for the ZPB project, makes possible exchanging information among students and teachers. Using the platform, students exchange their observations, seek teachers' advice, look for current information about organization of the activities, etc. They also make use of educational materials uploaded by teachers, report their results, check their scores, share opinions on various subjects. Teachers place information important for the students, upload scores and comments, verify students' progress.

An innovative system for the evaluation of students' achievement has been proposed for ZPB. Students are not given formal notes, as for

other subjects, they also do not take part in routine tests, oral questioning, etc. Instead, they score points for various aspects of their activity: creative thinking, communication, searching for information, actions. The scores are meant to stimulate the personal development of the students, to discourage rivalry among them and to promote co-operation and responsibility. Students are assessed by the teacher and by the other students for their performance during activities and for the results obtained in the individual projects, realised both in the school laboratory and as a homework. Table 1 shows the exemplary scoring system used for the assessment of students performance in the ZPB course.

On the first ZPB activity, students are acquainted with the goal of the course, rules of participation, the preliminary schedule of activities and the safety measures that must be observed in the school laboratory. Then, together with the teacher, students work out the guidelines for realization of the projects, homework, participation in excursions and field activities.

The ZPB textbook contains many propositions of activities in form of separate units. Every unit can be realised independently, according to the preferences of students and teachers. Of course, teachers and students can propose independently activities of their own concept and design. The typical unit contains a short introduction to the subject, and suggestions how the particular activity should be organised.

4. Preliminary evaluation of ZPB

The ZPB project has been run already for almost two years, and still continues at the present. It is too early to present the full results of the whole project, but some conclusions are evident from the preliminary questionnaire studies carried out at the end of the first-year cycle of ZPB course. The limited size of this article does not allow to discuss all the collected data in full, therefore only some most general conclusions are presented below.

Teachers who have conducted the ZPB activities (24 persons) express very favourable, even enthusiastic opinions about the course. According to them, ZPB activities address correctly the main goal of the project, focusing on developing practical and exploratory skills that have limited chance to be acquired during the regular Science, Biology, Chemistry and Physics classes. Students actively participate in

ZPB classes, showing positive, emotional attitude to the realised tasks: they discuss, ask questions, seek answers in available sources, cooperate with one another and with a teacher, present their achievements.

Even the students who are rather passive on other classes, have shown substantial engagement during the activities.

ZPB course develops the students' interest in natural sciences, stressing the unity of all natural sciences. This enhances the chance that students will pursue that interest in the future education. Skills acquired on ZPB activities will be helpful in their further learning and adult life. Teachers see also the synergy effect: active participation in ZPB results in better performance on other classes (Science, Biology, Chemistry, Physics). In general, teachers positively assess the components of the ZPB course: modular textbook, internet platform, scoring scheme, though they also have come up with many valuable suggestions of improvements.

Teachers are unanimous that there is a genuine need for such a course in the curricula of upper primary and lower secondary schools in Poland. In their opinion, it is entirely plausible to introduce the ZPB course from the organizational point of view, though they are far from thinking that it could be just added to the existing courses. They see it rather as a complex reworking of existing school programmes to accommodate ZPB with no substantial increase of student's time spent on classes. All teachers stress the importance of well-equipped school laboratory and appropriate funding as the critical condition for the ultimate success of the ZPB course. Some of them do not feel comfortable with the interdisciplinary character of ZPB. They point out, that it is difficult to run ZPB activities in the area of one discipline (e.g. chemistry) by the teacher who is a specialist in another discipline (e.g. biology). Since the special workshops for teachers carried out at the preliminary stage of the projects seem to be not sufficient, the development of a special guide for teachers with detailed instructions and safety measures is under way.

Teachers' views are generally shared by the students, who have taken part in the ZPB activities (total 1199 students), though conformity of their opinions is lower (70-85%). Students generally accept the innovative formula of ZPB, seeing the activities as interesting and inspiring. They have acquired and developed their practical skills in using laboratory

equipment and modern communication means (interactive whiteboard, internet platform). They feel satisfied because of their participation in ZPB and they declare the increased interest in natural sciences and further education in this direction. Surprisingly, students' views are not biased by the gender stereotype – most of them think that women can have the same achievements as men in the professions related to natural sciences.

	Co-operation & communication	Creative thinking & searching for information	Actions	Maximum points per student per year
1. Assessment during the activity in the school laboratory.	max. 3 pts	max. 4 pts	max. 3 pts	$\frac{400 \text{ pts}}{40 \text{ activities}} = 10 \text{ pts}$
2. Projects	Assessment of the projects realised in small groups outside the laboratory.	max. 15 pts	max. 15 pts	$\frac{320 \text{ pts}}{8 \text{ projects}} = 40 \text{ pts}$
	Assessment of the projects realised individually outside the laboratory.	max. 15 pts	max. 15 pts	$\frac{80 \text{ pts}}{2 \text{ projects}} = 40 \text{ pts}$
3. Test of science practical skills based on highly simulated tasks.	max. 10 pts	max. 15 pts	max. 15 pts	200 pts = 4 test * 50 pts
Total in one year				1000 pts

Table 1. A point scoring scheme proposed for the assessment in ZPB [5]

Reception of ZPB by school authorities (7 persons) has been equally warm. Directors support the idea of introducing ZPB to the curricula. They also welcome new, well-equipped laboratories in their schools. As a result of the project, some schools spontaneously decided to erect their own hothouses for carrying out biological experiments.

5. Conclusions

After the first-year cycle of ZPB course in selected Polish primary and lower secondary schools, the opinions of all important stakeholders of the project: students, teachers and school authorities, jointly point out that this course is very desirable in modern education of young people in Poland. The evaluation study paints a picture of non-conventional course, uniquely developing practical and exploratory competences, engaging students by its attractive formula, creating a positive image of natural sciences and complementing traditional science education at schools. This positive opinion is accompanied by the conviction, that introducing the ZPB to national curricula of upper primary and lower secondary schools is absolutely plausible, though this is a complex process that requires taking into account many other factors.

6. Acknowledgements

Authors acknowledge support from WND-POKL.04.04.04-00-007/10 and 530-8140-D198-12.

7. References

- [1] Podstawa programowa z komentarzami. Tom 5. Edukacja przyrodnicza w szkole podstawowej, gimnazjum i liceum. Załącznik do rozporządzenia Ministra Edukacji Narodowej z dnia 23 grudnia 2008 roku w sprawie podstawy programowej wychowania przedszkolnego oraz kształcenia ogólnego w poszczególnych typach szkół (Dz.U. z dnia 15 stycznia 2009r.)
- [2] CKE, 2009, 2010 egzamin gimnazjalny – <http://www.cke.edu.pl/pl/66-informacje-o-wynikach.html> [visited 17-May-2013]
- [3] Home page of the project "Zajęcia praktyczno-badawcze w powiecie elbląskim. Pilotażowy program wdrożenia nowego przedmiotu nauczania w szkołach podstawowych i gimnazjach". <http://www.zpb-innowacje.pl/>
- [4] <http://www.zpb-innowacje.pl/dokumenty> [visited 17-May-2013]
- [5] Kossobucka A., Karawajczyk M., Semczuk M., „Zajęcia praktyczno – badawcze. Program nauczania dla klas I – III gimnazjum”, Gdańsk - Elbląg 2011 <http://www.zpb-innowacje.pl/dokumenty>
- [6] Karawajczyk B., Przedpeńska K., Semczuk M., „Zajęcia praktyczno – badawcze. Podręcznik dla klas I – III gimnazjum”, Elbląg 2011 <http://www.zpb-innowacje.pl/dokumenty> [visited 17-May-2013]
- [7] <http://www.zpb-innowacje.pl/ipi/account/users/login>



BELIEFS OF TEACHERS OF MATHEMATICS ABOUT TEACHING IN A CONSTRUCTIVIST WAY

Mgr. Veronika Hubeňáková
Doc. RNDr. Dušan Šveda, CSc.

Institute of Mathematics
Pavol Jozef Safarik University in Kosice,
Faculty of Science
Slovakia
veronika@student.upjs.sk,
dusan.sveda@upjs.sk

Abstract. *Constructivist approach to mathematical education and inquiry-based mathematic instruction in mathematics are among educational scientists considered suitable, good and sometimes necessary alternatives to traditional approach.*

However, it is not a government, school, or researchers who make a key decision about whether this method is applied in practice or not. The key decision depends on a teacher and his/her beliefs about mathematics and its teaching.

Therefore, if we want to improve the quality of mathematics teaching in Slovakia, we need to understand beliefs of Slovak teachers about good education and afterwards find ways to influence these beliefs in a positive way.

These goals were achieved through qualitative research based on the following questions:

- *What beliefs about mathematics and its learning do Slovak teachers have?*
- *What are the beliefs of Slovak teachers about constructivism and inquiry based methods?*
- *What is the base of their beliefs?*
- *What are the ways to influence these beliefs?*

These questions were answered by a qualitative analysis and interpretation of data obtained through in-depth interview with teachers of mathematics and observations in classrooms.

Findings and conclusions of the research are presented in this paper.

Keywords. Beliefs of teachers, constructivism, inquiry based science education

Introduction

Constructivism is a theory of learning, which was produced by psychologists like Jean Piaget, Lev Vygotsky, and Jerome Bruner whose point of view was different from that of behaviouristic theory based on principles of operant conditioning. Constructivism underlines that everyone constructs his/her knowledge by him/herself. This means that it is impossible to teach a person without his/her own activity. At present, education systems in various countries are experiencing the same opinion gap as cognitive psychology at the beginning of the 20th century. Is it necessary to let children “construct their knowledge by themselves” through inquiry or is it better to give them direct instructions? We have experienced both of ways. Research and educational policy emphasize the need of transformation of our educational system into inquiry based. In contrast, many teachers do not adopt this approach in such a way which would be measurable by international assessments (TIMSS, PISA, etc.). One of the reasons is beliefs of teachers about mathematics and its teaching (in Guffin, 2008). Therefore we decided to answer these research questions: What beliefs about mathematics and its learning do Slovak teachers have? What are the beliefs of Slovak teachers about constructivism and inquiry based methods? What is the base of their beliefs? What are the ways to influence these beliefs? We consider a qualitative methodology the best way to find the answers. The methods are described in the next chapter. Next, we analyse

constructivism as “asking the right questions” and then we identify teachers’ beliefs which make them decide about whether they will teach in constructivist way. In conclusion we provide suggestions concerning future research and practice.

Methodology

In our research we cooperated with three experienced female teachers from Košice. All of them signed informed consent in advance. The teachers’ names were changed in this paper. Sophia is markedly constructivist oriented and she teaches at secondary grammar school like Catherine whose opinion is not that clear and elements of constructivism occurred spontaneously in her teaching. Third, Julia, teaches at elementary school and employs methods similar to Catherine’s. First, we observed two lessons and then we conducted an in-depth interview. It was followed by the second in-depth interview a week later. The creation of observational scheme and formulation of interview questions were inspired by The Questioner of Mathematical Beliefs (in Guffin, 2008). Later, we transcribed the interviews. We analyzed the data collected in this way by categorization, relations marking and creating of a theory. Research findings were sent back to the teachers to comment on their own quotes and correct possible distortions made by researchers’ interpretations. These quotes were not modified in the presented paper. They were translated as close to the original quotes as possible.

Constructivism as “Asking the right questions”

The lesson taught by Sophia to 13-14 years old children at secondary grammar school was strongly constructivist. She began with a task focused on repetition; we could classify it as a “routine exercise”. Two pupils solved it from behind the blackboard, the rest of class computed by themselves in their exercise books. Assignment was as follows:

- In my pocket there are “x” Euros.*
- a) *Peter has $\frac{3}{5}$ of that. How much does he have?*
 - b) *Johnny has $\frac{1}{3}$ less. Write an expression.*
 - c) *Marta has 75% of my budget – from “x”. How much does she have in her pocket?*

One of the students standing behind the blackboard revealed the right solutions to the rest

of the class. The other one's solutions were these: a) $\frac{3}{5}$ from x ; b) $x - \frac{1}{3}$; c) $x - 25\%$. Teacher commented on this situation later: "...when I have seen troubles which have arisen, I've considered it important to "chew" it. Otherwise, we won't be able to move on with next word problems." That is why she engaged the whole class and asked them the following questions:

- *If this is a problem for you, imagine a concrete number. How would you count it, if you had 300?*
- *How differently did you count it?*
- *Who of you got it right? (voting)*
- *How did you get it? (asking the one without right solution)*
- *Who has $x - x/3$? Who has $x - 1/3 * x$? Who has $x - 1/3$? (voting)*
- *I imagine that I have 300. So how much does Johnny have?*
- *Ok. Why? (asking a girl who has problems counting it) Let her answer it.*
- *Which of these expressions is right?*
- *When I said that Johnny has $1/3$ less, how many thirds does Johnny have?*
- *Modify $x - x/3$!*
- *Why is $2/3 * x$ the same as $2*x/3$?*

The teacher seeing serious deficiencies of her students turned the routine exercise into inquiry tasks by asking all these questions.

Another teacher, Catherine, teaches students in their first year at secondary grammar school. The topic of an observed lesson was Euclidean theorems. They focused on their utilization in construction problems. At the end of the lesson she provided the following problem and consequently she asked these questions:

Let's have a rectangle ABCD. There is a point X in it, which divides the rectangle into four triangles. Their areas are 4, 14, 15 and "?". What is the area of the triangle AXB?

- *Any constructive idea?(short pause without ideas)*
- *OK, when this is "b", how much is this?*
- *How do we count the area of the triangle AXD?*
- *How do we count the area of the triangle BCX?*
- *Do we know from this expression what it is?*
- *Students: And now we will do the same.*
- *When the area of green parts is 19, what is the area of non-green parts? (Two triangles are marked with a green chalk.)*

This problem is quite new for students and therefore it is very useful for inquiry. The teacher gave them only a short time to look for their own solutions. Then, by asking questions she changed the new problem into smaller familiar problems.

Our observations and interviews point at the fact that the assessment of questions asked by teachers is crucial for determining whether a teacher teaches in constructivist way. In addition, it is obvious that time given by a teacher to students to answer the questions plays a very important role, too. Neither the type of a problem (routine exercise or inquiry) nor using a modern technique imply a type of solution (algorithmic or inquiry). Moreover, this specification of constructivism as "asking the right questions" is independent of type of school and its equipment. Asking the right questions depends only on teacher's decision in the concrete lesson with the concrete class. Research confirms that an interaction between a teacher and a student is vital for performance of mathematical education (Kilpatrick, Swafford, Findell, 2001). In the next chapter we discuss the beliefs, which strongly influence teacher's decision about whether he/she asks the right questions and whether he/she provides students with enough time to answer.

Beliefs influencing teacher's decision about way of teaching

Beliefs about talent and effort

Teachers consider a talented pupil, who also devotes effort, clearly successful in mathematics:

„Practically, Anton is the one who is naturally intelligent. And because he was led at home, his parents used to give him some problems to solve all the time, so he was constantly improving“
 (Sophia)

In contrast, an untalented pupil, who does not take any effort, is not successful in mathematics:

“Certainly, those children fail in mathematics who don't have predispositions and who don't even try to change that“
 (Julia)

There was a high consistency in opinions of the teachers.

It is more interesting to see what teachers' beliefs about situations are when one of these conditions is not fulfilled. Firstly, a pupil may be gifted but spares no effort:

“There are pupils who aren’t willing to learn at all, but because they pay attention during lessons, they can’t do worse at the exam, even if they wanted to. Simply said, they grasp it during the lesson”

(Julia)

“There are many people in that class, who have the mathematical talent, but they didn’t want to improve. Lessons are „OK“, but math didn’t catch their hearts. So they sort of stunted”

(Sophia)

It is obvious that teachers observed success in terms of school duties. However, they believed that there is some kind of failure, too, because students did not develop their abilities appropriately. It is the belief, which was quoted by A.H.Maslow (1954): “What a man can be he must be”

Secondly, we can target at students who are not talented, but they work hard. We reckon that the attitude toward this situation is the key in teacher’s work. There are several reasons: First of all, usually there are not a lot of students who are labelled as talented and, furthermore, this term is practically understood unprofessionally. Only occasionally a teacher knows results of psychological measurements. It is hard to distinguish if someone is not talented or if he/she does not develop his/her talent. Therefore, in the present paper we understand talent only from the teacher’s point of view. Moreover, a hardworking student is the one, who cooperates with a teacher – in other words, the teacher’s tasks will be fulfilled by the student (or the student will try to fulfil them). Due to this fact, teacher’s beliefs about possible success influence considerably what mathematical experiences the student will have. In addition, research (Riordan, Noyce, 2001) emphasizes that pupils taught in an inquiry way achieve better results than their peers taught by a direct instruction. We notice two types of beliefs:

(1) *“Those who work systematically, also at home, well, they won’t become geniuses, but I think, they can achieve quite a good level”*

(Sophia)

(2) *“They can be partially successful. They can learn to solve some kinds of problems, especially the algorithmic ones, thus, they can earn it. But it will never be “IT“. Mathematical thinking won’t get into their minds, it can’t be learnt.”*

(Catherine)

The teachers agreed on a principle determining the choice of problems for students: they were adapted to their level. But there was a noticeable difference between the methods which were chosen for their solutions. The teacher who believed that a hardworking student can give a good performance did not change the method of solution. She asked inquiry questions to both – talented and untalented students. The following is what she said about avoiding this approach with weaker students:

“I reckon, when the students are weaker, and they don’t see it there, then it will be recognized. It means, that it will be obvious with weaker students first”

(Sophia)

On the other hand, the teacher who understood talent as inevitable for success, used inquiry questions mainly in the class of clever pupils. In contrast, she chose explaining in the class with mathematically less skilled children:

“Let’s say this class, where we were just now. They are a little slower, I can only occasionally give them thoughts to ponder and make links between them”

(Julia)

Beliefs about students’ preferences

On the one hand, teacher’s beliefs about students’ possible results play a role in his/her teaching. On the other hand, it is also important to know what he/she thinks about students’ preferences, how they imagine a good math lesson. The teacher who is markedly constructivist guesses that students *“like to think about it...”* (Sophia) and even denies potential resistance of students, because it is her priority, to let her students think. Although it is not necessarily simple:

“Sometimes, I was in situations, when I knew that some of the students weren’t listening to me but others were. Well, it certainly wasn’t with the younger ones. It was the older students, to have peace in the class. To avoid provocative questions, such as: “Why?”, “For what?”. To grasp the atmosphere in the best way, to explain in the most effective way, to get them where I wanted.”

(Sophia)

We assume that we should take into account the influence of class atmosphere, teacher’s own

answer to question “What is mathematics good for?” and ability of to motivate students as perceived by a teacher. To better explain the relations between these elements we need to integrate students’ opinions, too. That is why we do explore the relations in more detail in the presented paper.

Beliefs about outer conditions

Outer conditions are those which cannot be significantly influenced by teachers or students. These conditions can be a support, barrier or indifferent toward constructivist education. The teachers had difficulties with naming supporting conditions and they pointed out these barriers: too many students at lessons, lack of time, inappropriate textbooks and inappropriate preparation of teachers. The main difference between teachers is in their copying with the above mentioned barriers. For some teachers they pose a challenge; others perceive them as obstacles which cannot be overcome. In the following parts we discuss each of these conditions and based on our data we specify reasons for these differences.

Too many students

“I could imagine teaching a lesson in this way in a group of eight people. Certainly, it would be ideal. There we could work more effectively. If they worked in smaller groups, they’d compete with each other, everyone would make up some ideas, we’d discuss solutions ...But I can’t manage teaching thirty-two children in this way”
(Catherine)

The teacher’s belief about a degree in which a large number of students in the class is a barrier to the constructivist education is dependent on his/her ability to manage the concrete class and also on his/her noise tolerance. The teachers agreed that lessons taught in a constructivist way are noisier and more difficult for classroom management.

Lack of time

“It is true, that I’m often late with my plans, when I teach in this way. I mean, it is true, when someone says he has some plan and he has to stick to the plan then he has to leave out something or teach it only superficially”
(Sophia)

Teachers face a dilemma between “everything but superficially” or “in-depth but not everything”. On the one hand, teacher’s perfectionism plays a role. This feature exerts inner pressure and forces him/her to do things in the way they are planned. On the other hand, we can see outside pressure, e.g. upcoming school leaving exams or admission exams, control of headmaster or school inspection. There is, however, the difference in how particular schools put teachers under this pressure and how teachers can cope with it.

Inappropriate textbooks

“So, in my opinion, textbooks and collections of exercises and tasks could help. Now, there are none. There are new textbooks by one author, and the textbook for the ninth class wasn’t even published. It was written by a different author and published but with millions of mistakes.”
(Sophia)

This objection can be interpreted in two ways. Firstly, a textbook may be inappropriate for an individual teacher, because it is “too constructivist”. Its use in the classroom requires more time and extra preparation for a teacher. It is important to consider teachers’ experiences with textbooks written in other than a constructivist way. So it can be expected that they will have troubles with new type of textbooks.

Secondly, a textbook can be “not enough constructivist”. It is true, that students should use and search for more learning resources (NCTM, 2000). But in these days it is a teacher, who often has to do that. Inexperienced teachers could have serious difficulties in finding appropriate resources or creating their own teaching materials. Finally, to be a teacher does not automatically mean that a person is exceptionally creative and skilled to prepare good materials.

Inappropriate preparation of teachers

“Anyway, it is necessary to become familiar with this method. Teachers themselves should master the issue. Because if they want to do something well, they have to know what it is about. So, they should self-study or attend some lectures, simply said, acquire knowledge and then apply it in practice”
(Catherine)

The preparation of pre-service teachers is a great

challenge. Pre-service teachers nowadays have no personal experience with constructivist education. Research pinpoints that sufficient preparation of teachers in terms of applying a new method is one of key determinants which influences its putting into practice (Klein, 2004). Nevertheless, there are teachers who employ constructivist methods, which could be accounted for by their personality type which is “naturally constructivist”. They have a great need for self-reflection, they look for chances to improve their teaching, they share their experiences with colleagues, they are creative, etc.

Conclusions

To sum up, we can say that we observed a strong relation between the beliefs of the teachers proclaimed in the in-depth interview and their teaching methods observed during their lessons. This is fact that we assumed before we conducted our research based on the previously published data (in Guffin, 2008). We have considered the constructivist education as “asking the right questions”. This point of view enabled us to ignore the type of school and its equipment. Then we listed the beliefs influencing teachers’ decisions about whether they will “ask the right question”, namely: beliefs about talent and effort, beliefs about students’ preferences and beliefs about outside conditions. Future research could involve students and possibly measure beliefs of teachers in a quantitative way.

Based on our findings we add to those researchers who emphasize the following recommendations:

- In teachers’ education pay more attention to:
 - Education about constructivism as the theory of learning,
 - development of their ability to manage a class effectively,
 - development of their ability to motivate students.
- Concerning teaching materials, they should include student’s books as well as teacher’s books or a methodological guide for a teacher should be provided.
- Priority of quality over quantity should be clearly communicated and endorsed by the number of lessons in accordance with the curriculum.

References

- [1] Guffin, B. Teacher Beliefs Toward Inquiry-Based Mathematical Instructional Strategies in South Dakota Elementary Schools. United States. South Dakota: University of South Dakota, 2008 ProQuest Dissertations & Theses A&I. ISBN 9780549865513.
- [2] Klein M. The Premise and Promise of Inquiry Based Mathematics in Pre-Service Teacher Education: A Poststructuralist Analysis. *Asia-Pacific Journal Of Teacher Education* [serial online]. 2004; 32(1): 35-47. Available from: ERIC. [visited 13-May-2013]
- [3] Maslow A. *Motivation and Personality*. Harper & Row publishers; 1954.
- [4] Kilpatrick J, Swafford J, Findell B, eds. National Research Council. *Adding It Up: Helping Children Learn Mathematics*. Washington, DC: The National Academies Press, 2001.
- [5] NCTM. *Principles and Standards for School Mathematics*. Reston, VA; 2000.
- [6] Riordan J, Noyce P. The Impact of Two Standards-Based Mathematics Curricula on Student Achievement in Massachusetts. *Journal For Research In Mathematics Education* [serial online]. 2001;32(4). Available from: Academic Search Complete.



CYBERNETICS FROM THE POINT OF VIEW OF THE HANDS-ON PRINCIPLE

Max Igor Bazovsky

Abstract. *In this paper we introduce a three-phased person model (TPM) to provide a model of the student in the learning process, to provide insight into learning, and to provide Hands-On activities related to the TPM. The TPM is a metacybernetic model of the student, with a semi-duality in the nodes of the feedback loop. This Duality in Learning provides the student and teacher with new opportunities for better self-regulation, and better “self-production” as students/teachers.*

Keywords. Three-phased Person Model, TPM, Duality in Learning, reflexivity in learning

1. Introduction

Cybernetics is the science of control by feedback signals. That is, the output of a system is controlled to lie within a desired range of values by observing the output and taking action to regulate it. This is what education is about. After a brief discussion of some early cybernetic components we focus on meta-cybernetics, which in general is an excellent method for the highest form of self development. Then, to be more specific we use metacybernetics as a constructivist tool, a method to gain insight about teaching and self-learning.

1.1. Automatic feedback

This occurs in some designs, such as,

- a. the Watt steam controller, which controls by centrifugal force lifting or lowering two balls which in turn open or close a vent for steam
- b. the bimetallic switch which controls the input signal to a room heater or cooler by means of uneven expansion of two different metals joined together.
- c. The pressure cooker spring loaded vent valve; a safety device controlling pressure. The electric fuse, another safety device, controlling current
- d. Intelligent traffic lights for traffic control based on sensors implanted under the road surface, to sense the presence and flow of cars

1.2. Human-in-the Loop feedback

There are many examples: gas pedals, faucets, switches, policemen directing traffic at a football game or at a Rock star concert, etc. The human observer is also the decider in how to control, and when to control. We can call him/her/them the OD, observer/decider.

2. Innovation and Design As Metacybernetic Activities or Projects

Metacybernetics, or cybernetics of cybernetics (Refs.1,2) is the science of looking at cybernetic systems from a wider, and/or more abstract perspective. It is theoretically interesting as a

reflexive activity. It is a sort of controlling the controller - However, when we abstract the idea of "control" we realize that "controlling the controller" really means innovation of any sort! This understanding of metacybernetics helps and encourages the students to become innovative. What is needed is to provide feedback to make a solution that fulfills the original purpose and this will be done according to the consciousness and knowledge of the student.

We get a better idea of metacybernetics when we consider that Ramaprasad (1983) defines feedback generally as "*information about the gap between the actual level and the reference level of a system parameter which is used to alter the gap in some way*", emphasizing that the information by itself is not feedback unless translated into action. (Ref 3)

However, we propose, that "gap" needs to be replaced by something much more general in a metacybernetic context of education. We propose that the "gap" is the difference between "What is" (in a fixed limited focus of the student "as is") and a "vision of what the student could become". In this "incorporation", there might not yet be a definite "reference level", just a feeling of dissatisfaction. The student/teacher then has another "gap" to "solve" first. Before he/she can close the "original" one that gives a solution, a more definitive diagnosis is needed. The secondary or instrumental gap is the gap is between the feeling of dissatisfaction and the wish to solve the cause of the dissatisfaction. This secondary gap can be closed by finding some technologically realizable possibilities for solving the problem.

3. Duality in Learning: the Student as a Cybernetic Learning System

The learning process occurs by means of feedback loops such as learning from mistakes. Other sorts of feedback loops are, asking questions and getting answers, getting homework and responding to it, taking challenges and making efforts to solve them. In general these all are about getting information or stimuli and responding to them, creatively by means of various feedback loops that are key in student/teacher growth/development. This is modeled in Figure 1, described next.

There are four types of main nodes or components in the feedback graph of the TPM of the student/teacher. Each type appears exactly twice, but the "pairs" are different and separate.

Thus the feedback graph has eight nodes that are grouped together into four pairs to give two value systems, two project systems, two worlds, and two types of decision systems. (By “projects” we mean a set of coordinated action deliberately chosen by the student to achieve some values.

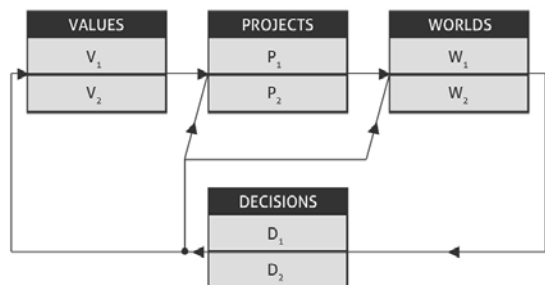

Figure 1. *The Eight Nodes and Four Feedback loops of Student Growth*

There are four types of main nodes or components in the feedback graph of the TPM of the student/teacher. Each type appears exactly twice, but the “pairs “are different and separate. Thus the feedback graph has eight nodes that are grouped together into four pairs to give two value systems, two project systems, two worlds, and two types of decision systems. (By “projects” we mean a set of coordinated action deliberately chosen by the student to achieve some values.

It is this duality that makes the TPM so useful and important, as the following detailed definitions will indicate,

- V1 the value system driven by hormones, feelings, moods and general body functions with little or no intercession from the mind
- V2 the mentally developed value system that is built up by the mind through the student’s learning experiences and the reactions to them
- P1 The projects that are actually designed, or chosen, to accomplish chosen values from V2
- P2 the projects that are intended to be designed or chosen to accomplish the deliberately chosen values of V2
- W1 the real world, or “neck of the woods” in which the student lives, including economic, social and stressor-physical environment
- W2 the world that the student’s mind builds up and develops over time. It

is the world as the student pictures it, and thinks he/she lives in

- D1 The decision system which the student uses during/in the project, or “in medias res” when executing a particular project and making “in the midst decisions
- D2 the decision system that the student uses “post hoc”

The nodes in the feedback graph in Figure 1 show how the student changes during the education process. For example, the student can decide to react to a poor test result by either dropping the course, restudying the material, changing majors, or making more drastic (e.g., disciplinary) changes to his/her lifestyle. These changes are modeled into the graph as the feedback to the various nodes.

3.2. A Model of the Mind-Body Complex

Figure 2 shows the body (body box) situated in the systems of the world, and then the mind (mind box) proceeding from the body. V1 and V2 are the two value systems also shown in Fig 1. The body is affected by the society, by education, by family interactions. The signals it receives are processed in the brain, by the mind. The mind interprets the sensor signals then it strives to explain and understand them in terms of predictabilities and patterns. (These patterns are interlaced with the babies/child’s/student’s actions). Finally it makes decisions to alter his/her W2, and V2 and now we are already “deeply” in the feedback loops in Fig.1.

3.3. Details of Mind Cybernetics: Start-Ups, Closing the Gaps

The baby’s mind learns through the body’s reactions, to develop pictures of the world. It reaches out and touches. It picks up and turns an object. It is developing its very elementary Mental World W2. It couples the body’s actions with the use of like/ don’t like, or pain and pleasure. It is using the body’s V1 value system, a given of pain registers, and pleasure reactions (nerves, hormones) to open gaps, or close them.. It is making decisions based on W2 and V1, and in doing so it is learning/ exploring W1 as well as developing itself.. In a way we can say the baby is „modifying gaps“ in a cybernetic sense.

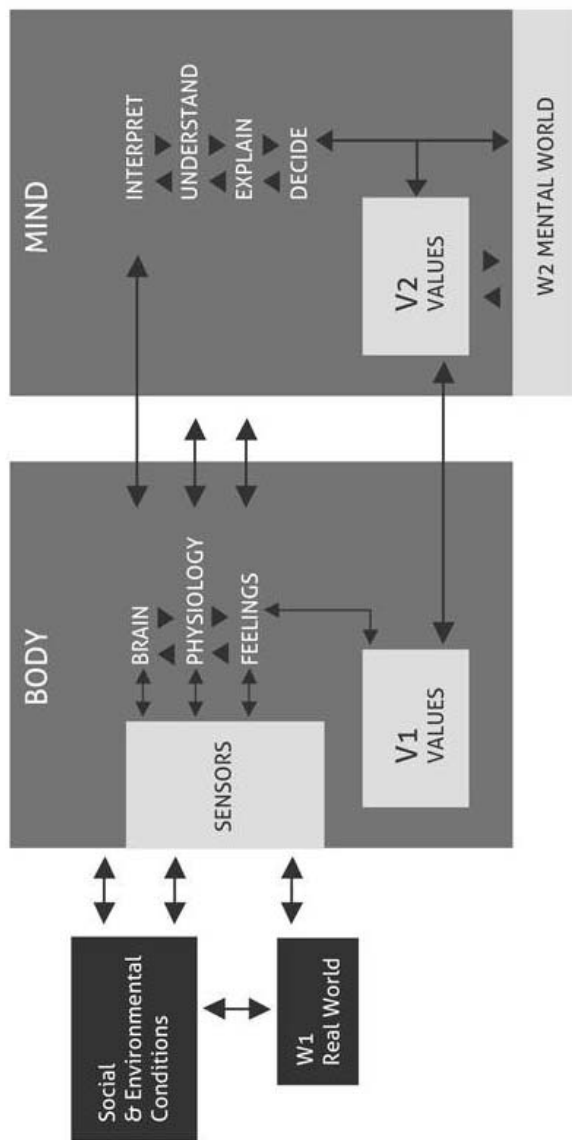

Figure 2. *The Mind-Body Complex Flows and Mental Productions*

As the baby grows in discernment, it learns to predict the pain or pleasure per learning some truths as consequences to actions and things. Now, with this predictionability, the baby is developing a mental value system, V2., and starts making decisions by coupling the growing W2 with the growing V2. At first the W2 has very small overlap with W1, but this continues to grow with experiences that the baby's mind-body complex encounters in the higher entities. As the child becomes more „savy“, there is a more purposeful attempt to build a good W2. E.g., when it encounters new phenomena, new experiences it sees things, it asks questions. It seeks to understand, explain things All this in W2. Finally it decides what to do to V2, and to W2, even if this decision takes place

subconsciously.

4. Hands-On Activity 1, Human Sensor System

Figure 2 shows inputs to the sensors in the body box. What are these sensors, or senses? Activity 1 studies the senses in more detail.

4.1. Starter Activities.

Students are to discuss sensors, using a Hands-On, Minds-On approach.

Discussion: it might be a semantic problem whether everything into the body is „sensed“. E.g., if the conscious mind does not sense it, then the body still can be harmed, and it is a question whether the subconscious mind „knows“ this, and if so, in what „sense“, does it know? Are there more sensors than the five senses (seeing, hearing, smelling touching tasting). E.g., sense of nausea from foul toxins, even if there is no sight or smell to the gas being breathed, or a sense of temperature, etc. Certainly the brain, and hence the mind is affected by inputs other than those coming from the „classic five senses“. Cf, the mathematician and physicist Blaise Pascal, said, in a rather punnish way,

„The heart has its reasons of which reason knows nothing.“

We also note that in a certain „sense“, The body has senses of which the conscious mind knows little or nothing.

Students list as many senses as they can think of. They discuss the conscious/subconscious aspect of sensing, and agree on a less ambiguous, more precise definition of sensors - -at least for the purposes of their current understanding/decisions.

Activity 1: One question is about the interrelation of senses. E.g., can you tell where a sound is coming from when your eyes are closed? When only one ear is used? Is there a significant difference between sound from the back and from the front of the body?

Answering this involves students blindfolding one of them while another moves a sound source (bell, beeper) around.

Activity 2: Another experiment involves students mapping their visual field using pins with a nice colored blob of cotton wool, while one student sits with eyes fixated constantly on a spot directly in front, on the board where the pins are being placed. This way the students map the

boundary of the limits of seeing (of „STILL“can see”, and „NOW, it disappeared“).

Activities 3, 4 and 5: Taste, Smell, and Touch are nicely described in “Neuroscience for kids” (Ref. 4).

5. Hands-On Activity 2, Reaction Times in Humans and in Cybernetic Feedback

We know that reaction time is important in feedback. Who has not experienced a room temperature airconditioning system that “hunts”, i.e., that overshoots to very cold temperatures and then overshoots to hot temperatures?

Activity 1: To show that different people have different variable reaction times. Each student is tested with “catching the stick” activity. A stick is placed just above a student’s hand, and let go without warning. The “experimental subject” is to react by catching it between thumb and pointing finger. The length of fall of the stick is measured and recorded for each student on various times, and various days. Each student then draws a graph of their results.

As an add-on activity, the stick can be given a push. Yes this will be a variable push, but the results will still be relevant. They show that reaction time is also a function of how quickly the “controlled” signal is changing.

Activity 2: To simulate how hunting can occur if the reaction times are slow with respect to the output signal being regulated. This student simulation game-activity illustrates the influence of delays upon the feedback system. The control signal must arrive in time before unwanted effects occur in the controlled output. The following simple game illustrated this nicely.

Required materials

- a. a set of different graphs such as two parabolas, one on a vertical axis, the other on a horizontal axis, an S shaped curve, and various other curves, including oscillation curves, drawn on graph paper with Time as the horizontal axis, and parameter Magnitude on the vertical axis. Each graph has its number. They are numbered consecutively.
- b. A set of easy linear kinematic problems that can be solved in a minute or two by the students (e.g., problems stemming from the equations of motion in E1 above).

Activity 3: The students simulate control of the

temperature of a device with a “known” response curve, given by its graph of uncontrolled response (e.g., growth) and its feedback response curve that shows how the output temperature decreases when it receives the signal.

Simulated Delays The delays in control are simulated by the time that a student takes to solve a problem picked at random from the problem box. Then a student reads off the appropriate graph to determine what level the output temperature has reached (it could be critical, (meltdown) if the problem is not solved at all, or it could be “damaged” if the solution arrives late.). If the solution is timely, the other graph gives curves for the temperature control. Overshoots can be modeled in this way too. If the overshoot is large, and the responses are always a little too long, “Hunting occurs”. This is simulated too.

6. References

- [1] Glanville, Ranulf, Second Order Cybernetics, <http://www.facstaff.bucknell.edu/jvt002/BrianMind/Readings/SecondOrderCybernetics.pdf>
- [2] Principia Cybernetica Web, <http://pespmc1.vub.ac.be/CYBSNAT.html>
- [3] Arkalgud Ramaprasad, "On The Definition of Feedback", Behavioral Science, Volume 28, Issue 1. 1983. Online PDF last accessed 16 March 2012.
- [4] Neuroscience for kids, <http://faculty.washington.edu/chudler/chte.html>

Acknowledgement

We are very grateful to Jozef Mikula, freelance artist, Rohov, Slovakia, for the artwork in figures 1 and 2.



SUMMER CAMPS SCHOLA LUDUS: EXPERIMENTÁREŇ

Viera Haverlíková
SCHOLA LUDUS, Fmfi Uk,
Bratislava, Slovakia
viera.haverlikova@gmail.com

Abstract. *The paper summarized ten years of "SCHOLA LUDUS: Experimentáreň" summer camps focused on active inquiry based non-formal physics education. Presented are didactical principles, goals and working methods used in summer camps.*

Keywords. non-formal education, physics, summer camp

1. Introduction

SCHOLA LUDUS project is focused on non-formal, progressive education for all, through personally gained experience in context of environmental imperatives. Its integral parts are scientific-cognitive programs and thematic tasks in the form of games, creative-discovery workshops, three-dimensional exhibits, non-traditional multimedia and a unique science popularizing and educational websites [1, 2]. Since 2003 SCHOLA LUDUS realized every year the physics summer camp Experimentáreň at the Faculty of Mathematics, Physics and Informatics, Comenius University, Bratislava. The camp is intended to children aged 9-15 years. They observe natural phenomena, perform experiments, build their own measuring instruments, discuss and play for a period of five days.

2. Addressees

Main addressees of the SCHOLA LUDUS summer camp Experimentáreň are children at lower secondary school level. There is no other limitation except of age.

According to a constructivists view ages 9 to 15 sees a finish to the concrete operational stage (till 11) and the beginning of formal operational stage (between the ages 11/12 to 14/15). Therefore this age is characterised by a shift from action (doing) to mental operations which are at first connected with concrete subjects. Younger children cannot list factors which influence some phenomena. If they look for the cause of the

phenomena, they begin directly with action – trial and error. They are capable of concrete problem solving. They are good in inductive logic. Older children can design a hypothetical list of factors and inquire each factor separately. They become able to think about sentences, whether they are true or not and began to understand the process of hypothesising. Successively they are able systematically test hypotheses and consider several aspects of the phenomena at the same time. Little by little they can use and construct abstract concepts and generalize.

Though Experimentáreň is a physics camp, neither former science education nor talent is required. In fact most of participants are interested in science and technology. But some children come to the camp because of their parents' interest and persuasion, that participation in the camp can help to build positive attitudes to science education.

3. Goals

The main goal of the camp SCHOLA LUDUS: Experimentáreň is to inspire children with science, maintain their curiosity and encourage their discovering.

The general goal of all educational activities realized in summer camps Experimentáreň is to develop children's cognitive skills: to define the problem, ask questions, produce and verify hypothesis, propose an experiment and perform it, collect and interpret experimental data, solve the problem creatively and, last but not least, to be aware of own cognitive progress – to understand the value of knowledge and value of the way it was constructed. The emphasis is put on development of competencies to obtain, to prepare and to evaluate information; and to development of communication skills including ability to enforce own opinion in an appropriate manner, to argue as well as to listen and accept other opinions.

Nowadays children, especially those, who live in urban area, have only little opportunity to gadgeteering. They have very limited experience with handling various materials and with using technical instruments. One of our goals is therefore to give participants opportunity to fill this gaps.

Besides cognitive goals, communication and interpersonal competencies are developed.

4. Program set-up

In the first year the program of the summer camp was composed as a set of five relatively independent parts. Each day was focused on specific physics branch. Activities were interconnected through stories of baron Munchhausen and the task: Decide which part of the story is a truth and which is a lie. The content variousness increased participants' possibility to meet their preferred branch, but at the same time decreased possibility of in-depth understanding. Since the second year the scientific program of the camp was focused each year on one special topic – either part of physics, or a material used for experimentation. Seemingly this is a constraint. In fact it enables immersing into the topic encourage deeper understanding.

- 2003 – Unbelievable adventures of Baron Munchhausen, or what is a truth and what is a lie?;
- 2004 – Optics;
- 2005 – Balloons;
- 2006 – Water;
- 2007 – Acoustics;
- 2008 – Centre of gravity;
- 2009 – Paper physics;
- 2010 – Energy;
- 2011 – Meteorology;
- 2012 – Food physics.

The scientific content of the camp is chosen in order to attract children's interest and support understanding the role of science in various areas of our lives.

The requirement of the accessibility of investigated phenomena, their connection to participants' daily lives and the possibility to make connection to contemporary science are taken into account during development of particular activities.

5. Experimentáreň

The name Experimentáreň means the place where experiments can be carried out. The summer camp SCHOLA LUDUS: Experimentáreň is a unique space for:

- children's experimentation - mainly with

natural phenomena and real object; including the process of planning the experiment and children's respective interpretation of results,



Figure 1. Making a wind indicator, 2011 - Meteorology

- authors experimentation – with different forms and methods of teaching and learning, with different types of motivation, stimulation of cognitive processes and feedback.
- The basic approach used in camp is inquiry based learning that is hands-on, minds-on and hearts-on. The summer camp Experimentáreň helped to develop the form of creative-discovery workshop (CDW) [3] and educational game as a teaching method [4]. The SCHOLA LUDUS learning cycle [5] is applied.
- pre-service and in-service teachers experimentation - first-hand experience with innovative teaching methods, educational activities, unique opportunity to investigate children's alternative concepts and approaches. Because the teachers' presence influences children's feeling of freedom and comfort, separate camps for teachers are offered. Selected activities developed for the summer camp are published every year as teachers' guides.

6. Experience

Children's (and parent's) annual interest in summer camp SCHOLA LUDUS: Experimentáreň proves that designed programs are attractive to them. Approximately two third of participants took part in the camp more than

once, arranged truly friendly relations to other participants as well as to facilitators.



Figure 2. CDW Deformation, 2012 - Food physics

Children's replies show that the suggested activities respond to their interest, and stimulate their knowledge and skills development.

Children are not used to work systematically. Most of them are satisfied with first idea, first solution. Without facilitator guidance children do not critically analyze their proposed problem solutions and realized them immediately.



Figure 3. Modelling game, 2004 - Optics

It is necessary to hold children's concern for presented issues by continuous questioning and step by step raising difficulty of tasks.

Motivation through the whole-week-story providing the learning context and the whole-week-competition are well proven. The prize is not important. Children just like to be admired.

Creative-discovery workshop and conclusive game, where children demonstrate acquired skills and knowledge are identified as the most popular forms of activities. Several workshops and games were adopted for using in school science

education.

7. References

- [1] www.scholaludus.sk
- [2] Teplanová K. SCHOLA LUDUS Virtual Science Centre: Building e-framework for New Paradigm of Teaching and Learning. Proceedings of 14th International Conference on Interactive Collaborative Learning; 2011 September 21 – 23; Piešťany, Slovakia, IEEE, 2011, p. 608-610
- [3] Haverlíková V. SCHOLA LUDUS serious educational games: The problem of mechanic balancing in virtual and real games. Proceedings of 14th International Conference on Interactive Collaborative Learning; 2011 September 21 – 23; Piešťany, Slovakia, IEEE, 2011, p. 615-619, art. no. 6059660
- [4] Haverlíková V, Hodosyová M: SCHOLA LUDUS Creative-Discovery Workshop in Formal and Nonformal Education. Proceedings of the Conference of Slovak Physicists 2009, September 16 – 19; Bratislava, Slovakia. Bratislava: Slovak Physical Society, 2009. p. 99 - 100
- [5] Haverlíková V. SCHOLA LUDUS serious educational games: The problem of mechanic balancing in virtual and real games. Proceedings of 14th International Conference on Interactive Collaborative Learning; 2011 September 21 – 23; Piešťany, Slovakia, IEEE, 2011, p. 615-619, art. no. 6059660
- [6] Teplanová K. SCHOLA LUDUS Theory of Teaching and Learning. Proceedings of the Conference of Slovak Physicists 2009, September 16 – 19; Bratislava, Slovakia. Bratislava: Slovak Physical Society, 2009. p. 93-94



KNOWLEDGE THROUGH SCIENCE AND ART

Stefureac Crina

“Mihai Bravu” Technical College,
Bucharest, Romania

crina.stefureac@gmail.com

Abstract: *The reality is investigated either by science or by art. Science and art are areas considered often distinct. In this paper I support the idea as well as, between them, there are not only differences but also many similarities.*

The reality, the surrounding world is better investigated, explored, understood, played back, interpreted and used by dialing to both aspects: science and art. A comparative analysis is interesting. Science and art are complementary because society needs both civilization and culture. In a way, doing science is an art, but also science is a rigorous field based on logical reasons. Scientific knowledge is possible in the repeatable events or processes. Science tries to represent fundamental aspects of reality. In fact, there is no understanding without symbols or abstraction. This is the level of mind where imagination was born. Art is not reflected by definitions. Here is a clear distinction between science and art. Art handle or reflect unique events, unrepeatable moments, inimitable points. Art expresses knowledge, is linked to science but is led through the eyes of the author, and is presented in terms of author emotions having individual tent.

Knowledge of reality through simultaneous use of the two methods, science and art, occurs less in the school curriculum in Romania. In school textbooks this aspect is represented only in some optional lectures. I support the idea that using simultaneously the method of investigating both by science and art, would increase interest and attractiveness to study science. Thus, we should start by introducing lessons in the curriculum on which the two aspects interfering and especially in the clubs for students with extracurricular activities, summer schools, long term projects etc.

For specialists is necessary, of course, delimiting the domain of investigation. For students, however, use of interactive investigation by science and art has undeniable advantages: harmonious development, discovery of unsuspected, hidden talents, increase creativity, imagination and spirit of investigation.

The paper contains basic ideas on ways or modalities of investigating reality through science and art. Are highlighted personalities of humanity belonging to both categories, without being able to put borders between areas to which they belong: Leonardo da Vinci, Jules Verne, Escher. They are complex minds or talents, fine observers, investigators, interpreters and connoisseurs of the mysteries of nature.

In this paper I propose several topics for interactive study of phenomena or aspects of nature, accompanied by several arguments, indicating the possibility of their use in both areas: science and art, together in school. I have obtained good results with students by supporting of such lessons.

I'll do some references on my participation to mobilities in Lifelong Learning, for continuous forming of teachers, in Comenius, Study Visits and Grundtvig programs.

Keywords: abstract representation, architecture, art, biology, chemistry, classroom, comparative analysis, complementary domains, computer, computer graphics, computer drawings, creativity, decorations, different, emotional, investigation, interpretation, knowledge, literature, mathematics, music, own perception, painting, paradigms, physics, reality, repeatable, science, science fiction, similar, unique.

1. Introduction

The world is as we see and how we feel!

Science and art develops due to the experience (Aristotle). I'll quickly memorize a few examples about how much humanity has accumulated experience from Aristotle to the present, focusing on science-art symbiosis.

I teach physics for 37 years in a high school. A few times I have the opportunity to apply what I'll support below. Most of the methods proposed in the present paper I support in extracurricular activities because curricula in Romania provides and allows very few lessons of this kind. These activities are: the club "Friends of Science and Art", workshops, roundtables, meetings with scientists and artists, symposia, publications in the school magazine, creative competitions on topics of science festivals, sketches with these themes.

I begin by quoting some of the personalities opinions about aspect of duality Science-Art:

*“Why does the eye see a thing more clearly
in dreams than the imagination when
awake?”*

Leonardo Da Vinci

*“The most beautiful thing we can experience
is the mysterious. It is the source of all true
art and science”*

Albert Einstein

*“You see things; and you say why? But I
dream things that never were; and I say why
not?”*

George Bernard Shaw

*“The most exciting phrase to hear in
science, the one that heralds new discoveries, is
not “Eureka!” ... but “That’s funny!””*

Isaac Asimov

2. About cognition and our brain

Our left-brain is home for our linear and mathematical side. Here lives the part that enjoys systematic planning and outcome measurements, research databases and long check-off lists.

The art of fundraising is primarily right-brained. Perhaps our most important right-brain fundraising tool is our ability to listen to and tell stories.

Why is this distinction important? Because by understanding both the science and art of fundraising, we can help somebody reframe his life, moving from scarcity to abundance.

Should use both left and right our brain, the linear and creative parts of our brain.

There are Bridges between the two sides. Some people have brains developed very special with many bridges! We believe that the early years of education in both directions are important. The human brain is the most complicated and mysterious thing. Each person has brain structured differently so that we can say that on the Earth is billions of ways of perceiving the world.

3. Differences which separate art from science

Science and art are fundamental creations of the mind and understanding, serving to reflect reality and to shape nature from spiritual and practical needs.

So, where exactly is the separation, barrier between art and science?

Addressing simply to this problem we can separate science from art.

When we think about the scientific process, a specific vocabulary comes to our mind: experiments, objectivity, facts, measurements, research, laws. In the passive sense of the scientific paper, we imagine a perfect reflection of the real world. On the other side, paintings can be profound, but means products that influences and affects our senses, emotions and intellect.

Science is useful, makes our life easier. Art is beauty, makes life more pleasant.

Science is the study of how nature works in the universe. Art is expressing human’s emotions, feelings, and views about the world.

Everything is science to the mind. Everything is art to the soul.

Science is about establishing truth, while art is a matter of the perceptions of the creators.

Science is the representation of natural order, while Art is the representation of human thought.

We must proof things in science. We don’t have to proof anything in art.

In science we explain, in art we create.

When we talk about science we must be exact, logical and know how to explain or demonstrate on the basis of laws or theories with “art”. When we talk about art, whether it is music, painting or film, we appreciate its value through the impact it has on us, this value coming from the intertwining of talent and passion with “science”. Scientific truth is based on an objective analysis, while truth can’t avoid subjectivity in art.

Knowledge in science is the researcher's own perception. In art, knowledge is emotive, based on aesthetic reflections.

Scientific knowledge is possible for repeatable events or processes while art detects unique.

Science can’t give up to the definition of the concepts which operates while art is not reflected in the definitions.

Science is characterized by its universal character while art expresses the feeling of uniqueness.

Language of the two forms of investigation, art and science, differ.

Knowledge in science uses a specific language, unambiguous and builds unmetaphorical analogy with common language. The formal language establishes a functional dependency relationship between concepts. Definitions determine the connection between concepts and terms, ensuring the link between knowledge and language. Scientific knowledge should be public, and the transmission of knowledge is done by describing the respective process, by recourse to a language as close to natural.

Scientists employ a variety of advanced technologies that stretch their ability to observe events far beyond normal human experience. Using a satellite telescope, an electronic microscope, brain-scanning devices, particle accelerators, and other scientific instruments, modern research techniques and mathematical tools make it possible for researchers to: see deep inside our brains, discover everything possible about the Earth, Moon, and Sun, examine the behavior of various plants and animals, including humans, observe microscopic life forms, examine the tiniest known particles, search for life beyond Earth.

Language of art resort also to concepts, but that's much closer to the natural and therefore better understood by the public. Expression in art is often rhetorical and knowledge in this area is actually a form of the personal experience of each artist. This knowledge is empirical and has, largely, a magic, supernatural substrate. Art is representational. Through the use of symbols, such as visual shapes and colors, musical tones, words, body movements, art represents, or points to, those things that we care most about. Art raises social and cultural awareness, makes the invisible visible, connect the improbable, breaks down artifice and presumption.

Any reality that can be passed on artistic or technical or scientific way should be an abstraction. However, the abstraction in art is different from that of the science, because it tends to symbolize subjective experiences, feelings, emotions.

4. Where Science & Art Intersect or Have Common points

"Science and art are not separate each from other. They assist us in observing nature. With the help of science we can discover the routines of nature. Through art we can describe the emotions of nature."

(Cheng-Dau Lee, Nobel Laureate in Physics)

Scientists and artists have a lot in common. Science and Art need Each Other.

Science and art are intertwined, representing nature in all it has more beautiful and deeper. They are complementary domains and in no way exclude each other.

Centuries ago, science and art were not separated like they are today. An artist and a scientist were often one in the same person. Today, science and art are more specialized, more divided. But there

is a new interest in closing that gap. Scientists are beginning to make art that is related to their work, while, at the same time, artists are incorporating scientific concepts into their art. Both are beginning to think like one another, as it used to be in the days of Leonardo da Vinci or Jules Verne. They are complex minds or talents, fine observers, investigators, interpreters and connoisseurs of the mysteries of nature. Many personalities of humanity belonged to both categories, without being able to put borders between areas to which they belong.

Consider the Duomo (Milan Duomo/Cathedral). It is the result of collaboration of science with the art in human hands. Therefore the name expresses this (D'homo)

One of the ways that artists and scientists confront change is to ask questions. At the center of most successful art works and scientific research is a simple question, something the artist or scientist is attempting to understand or explore. And it is our curiosity – the questions that we ask – that leads us to the kind of creativity that makes a difference.

Art and science share the goal of identifying with nature, including a predictable fascination with human emotion, thought and behavior. Both science and art aspire to truth without compromise. Both challenge the way we see the world as individuals and community.

Art and Science can be compared to the Chinese Taiji symbol „Yin and Yang” where Art is the Yin and Science is the Yang. Yin is the dark, passive, cold, mysterious part, associated with our imaginative, creative brain, while the Yang represents the luminous, hot, active, strong, clear part that is associated with the logical brain that enjoys science. The circle that encompasses them both represents everything, wholeness. In the Taiji symbol the Yin has a dot of Yang and vice versa meaning that every opposite has a part, or a seed of the other, and all is interconnected in the magical dance of life. In the same way Art and Science interconnect together making our life complete and beautiful.

It is well known the theory of light duality affirmed in 1926 by Niels Bohr. Light behaves either as an electromagnetic wave or, as a particle, depending on the conditions of its interaction with the material. This aspect was the subject of much dispute among physicists. Niels Bohr solved this contradiction by saying that light is not just a wave, nor just a particle; it has a dual nature, are both, a wave and a particle. A similar duality exists between Art & Science.

There are many Museums of Science and Art that successfully bring in evidence this aspect: Art is used as a means to illustrate science, and Science is instrumental in creating art. Such a combination between Art & Science in a museum is unique, making it the first of its kind. Also, should look like many of the lessons/activities developed by teachers with their students.

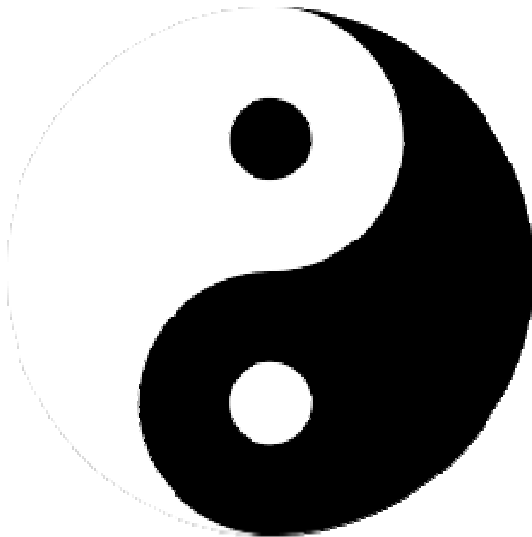

Figure 1. The symbol „Yin and Yang”

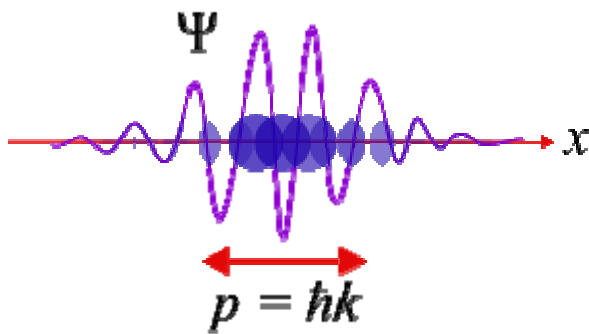

Figure 2. Wave–particle duality: $p = \hbar k$

Twenty-first century science, especially new discoveries in evolution, genetics, neuroscience, physics and chemistry, is changing the way we see ourselves and our societies. And it is causing us to think differently. To establish this new vision of nature-dependent values, it will require artists working closely together with scientists, to lead the way.

Art and science awakens and keeps alive in us the sublime order and elegance of Nature. The experiences resonate with us, because we too are Nature.

The architect is not only an artist but also a

scientist. He must have knowledge of mathematics, of physics constructions, etc. The teacher of physics is not only a scientist but should have more knowledge about the arts to fully explain the laws of nature.

Artists have always been interested in big scientific discoveries and ideas. Big ideas have emerged from a variety of disciplines at different times and places throughout history. The best art changes the way we see the world, and it is often big ideas that drive that change. Today many big ideas are associated with science and are continually attracting the interest of artists. The best of who we are is represented in our art and science, viewed as a whole. Art and Science make predictions about the future together.

The art without the science values (from math, physics, chemistry, biology) is only a part of the whole, but is also true that the science without art is only the second part of the whole.

By science and art our life became comfortable and enjoyable.

Art is associated with beauty, but beauty means harmonious proportions, and this is based on geometrical shapes and mathematical equations. Art is the highest form of expressing human feelings but it is difficult to be a great artist without having a solid scientific basis, without using tools from mathematics, physics, chemistry, biology, strength of materials, or others.

Today, and in the future, we must require the collective voice of the science and art community, world around, to help mediate the exciting and frightening challenges that loom ahead. It is well to keep in mind to educate the future generation in Science through Art, and vice-versa.

There are many museums in the world that shows us The Science and Art in One Face, as a whole but I think there should be much more for the harmonious development of our children.

5. Examples of bridges or similarities between Science and Art in Human History

"Leonardo da Vinci, scientist and artist" (1452-1519), painter, sculptor, architect, musician, mathematician, engineer, inventor, anatomist, geologist, cartographer, botanist, and writer.

As painter he has developed a "theory of knowledge" in which science and art are intertwined, are interconnected. In his treatises, he has made studies of "Science of Painting" in

which Leonardo wanted to prove that painting is science. He sought to create illusion in painting, bringing the painter to a deeper knowledge of the principles of mathematics and optics. He gave practical advice on how should painted visual effects such as light, shadow, distance, atmosphere, smoke and water or on how to show certain aspects of the human body, such as facial expressions or body proportions.

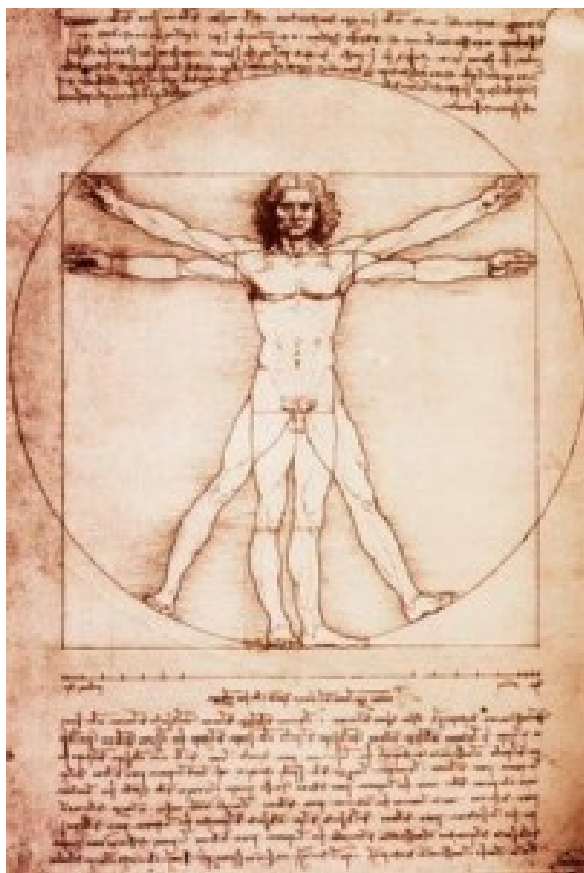

Figure 3. *The Vitruvian Man (1485) Leonardo da Vinci*

Leonardo da Vinci studied anatomy as obligatory part of the preparation of the artist and has made many observations on the proportions of the human body. Leonardo was an excellent architect, but also a very good engineer. He reflected the mechanisms of nature, was inventive builder, military engineer, hydraulic engineer. Some inventions are: machinery and tools, demonstration models, threads, gears, joints, hydraulic levers, and pulleys swivel mechanisms, fortifications in Florence, flying machine based on the study of bird flight. Mention studies on the water and air, the water and air properties, laws of motion in fluids and of fluids currents. Leonardo da Vinci was perhaps

the artist most identified with science or the scientist most identified with art.

The arts can help us reattach sciences to the world that we investigate. Works of art lead to new scientific experiments, which lead to new works of art and so on... Instead of ignoring each other, or competing, or co-opting each other in naive or superficial ways, sciences and arts will truly impact each other. If we are open-minded in our answers to these questions, we will discover that poems and paintings can help advance our experiments and theories. Good example is Jules Verne.

Modern science has stimulated and boosted the avant-garde artists' imagination, which revolutionized the artistic language and art, in turn, has predicted and even raised questions in scientists' minds, which meant that art contributed to the development of scientific theories, too. Good examples are Dali, Escher, Picasso.

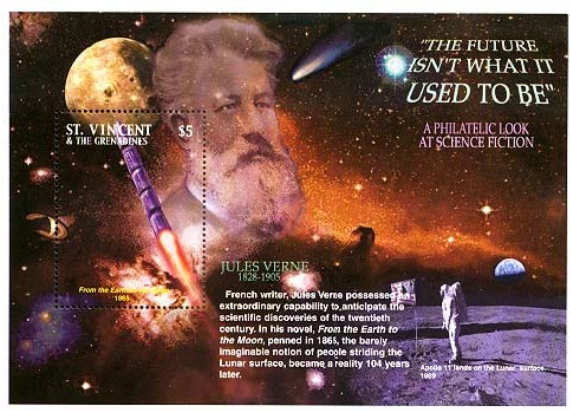

Figure 4. *Anniversary stamp*



Figure 5. *"Persistence of Memory" Dali (1931)*

Jules Verne (1828-1905) was one of the first authors whose work could be called Science

Fiction. He used the enormous technological progress of his age as a catalyst for telling stories. He was passionate for science, was futuristic prophet, artist but also scientist, through the talent which he describes the mechanisms and nature in his famous novels as: A Journey to the Center of the Earth, Twenty Thousand Leagues Under the Sea, Around the World in Eighty Days, Captain Nemo.

Dali was a Spanish artist (1904-1989), a surrealist painter, who performed essentially realistic representations of unrealistic subject matter. The subject matter itself is representative of something, but that depends on the painting and the artist. Dali was constantly concerned with theories that have revolutionized science: Einstein's relativity, the discovery of DNA. His paintings are strongly influenced by these scientific discoveries. Einstein, on special relativity theory (1905) showed that the time, as well as the space, is not an absolute, universal quantity, because is dependent on the observer, specifically, is relative to the system of reference, or to the speed at which travelling relative to another system of reference. In 1915, in the publication of general relativity, he further showed that gravity is a curvature of space-time, and that in higher gravity, time also slows down. This has since been confirmed experimentally countless times, to increasingly astounding, mind-boggling precision. Although Einstein achieved an unprecedented degree of recognition amongst the general public for a scientist, but his theories have not become instantly well-known to the average, non-technically-trained individual. However, at least among the intellectuals, including the artists, his ideas made some major waves. So, his most well-known work, Dali's "Persistence of Memory" (1931) documents the warping of one of the fundamental pillars of reality, time itself. Dali illustrates how time can be fluid, as in a dream. But a more essential and threatening association concerns our dependence upon clocks. The world runs by the clock, scheduling events is essential for life to function normally. If clocks melt, time becomes meaningless, and there is no way to control activities, leading to chaos.

Einstein's theories on space and time are not only interesting but necessary to many fields of theoretical, experimental, and even cutting-edge applied physics. However, for most people, at least until we will travel to other planets at near-light speed, or living in major gravity wells, time

dilation and other relativistic effects, don't seem to be a part of our everyday experience. But one of those effects, relativistic mass, turned out to be very relevant to the everyday citizen. Einstein showed that, since mass is relative to one's velocity, but simultaneously, velocity is also related to one's kinetic energy there is something called mass-energy equivalence. Einstein came up with the world's most famous equation to show exactly what this equivalence represents: $E=mc^2$. Forty years later, the top Allied physicists saw the fruits of their works. They figured out how to found energy from inside the atom, just as Einstein said, by converting mass into energy. This energy is practically boundless. Such a disaster has occurred in Hiroshima, then Nagasaki. Over 100,000 people died in two separate, very short moments. Dali represents this in a painting, called "The Disintegration of the Persistence of Memory". Now he shows us the revenge of relativity theory. Dali's new painting simultaneously depicts the end of the world as we know it. If even the atom itself, whose name means "indivisible" in Greek, is not safe, what is left to us? The apparent fragmentation of reality image, where all absolutes things seem to crumble, parallels the loss of security and permanence in everyday life in the post-war era. Imagine the sense of vertigo after two cities are wiped off the map with a weapon of god-like power. There are several images suggesting chaos, including the ocean fragmenting into atomic bits, its skin like edge lifted to reveal a fish fluorescing. Yet there are other images that suggest continuity as well, particularly in the details of Dali's beloved landscape. The image is a mixture of disintegration and continuity at the same time. Time is interrupted but in the same time it is fluid and elastic. Looking under the ocean's surface, we discover both disintegration and order. Dali leaves the answers to the viewer.

Here, at the advent of the Cold War, is suggested that a weapon is poised that could annihilate its target, but only while irrevocably altering the world and the future. Maybe suggested that, for another forty years after this, the world will live waiting for nuclear war? No hope from humanity, no hope from science. This wouldn't be the last piece by Dali to feature the horrors of nuclear war as a subject.

Dali was also fascinated by DNA and the tesseract (a 4-dimensional cube). Biology was radically changing the world by the late 1940. Was determined the chemical ingredient in the

chromosomes that carried an individual's genetic information, the so-called code of life, was a particular kind of molecule called deoxyribonucleic acid. In 1953 scientists were finally able to figure out what it looked like. This discovery captured the public imagination. This elegance was called "the Mona Lisa of modern science".



Figure 6. "The Disintegration of the Persistence of Memory" Dalí (1950)

Dalí created work "Butterfly Landscape" (1957) being inspired by this discovery. Though this was the first work, created only a few years after Watson and Crick's announcement of the double-helix, but DNA was shown up in many of Dalí's next works. It is perhaps easy to see how butterflies are born and rises from the iconic structure in this painting. It seems that Dalí used DNA to symbolize not only creation, but also the greater idea of God and this may be how some of the molecular structure is visibly jutting from the clouds.

Physics has dominated the public imagination for more than the first half of the twentieth century through radio, the discovery of the atom, nuclear weapons, spaceflight but the biology, also fought for attention, through the elimination of smallpox that seemed to suggest an eventual defeat of all disease and genetics. Salvador Dalí created a lot of works and certainly took inspiration from a myriad of different topics, not only from science subjects. He had something to say on different subjects: history, politics, science, art, and even on the future, addressing religious symbolism, political figures, or any combination of the above. Dalí's expansive artistic repertoire included film, sculpture, and photography.



Figure 7. "Butterfly Landscape" Dalí (1957)

Escher, "Master of Infinite" (1898-1972), was a Dutch graphic artist known for his often mathematically inspired woodcuts, lithographs, and mezzotints. He was fascinated by impossible constructions, explorations of infinity, unrealizable architecture, 3-D objects on a 2-D plane and tessellations. He used extensively in his work geometric ideas, particularly those of Euclidean, hyperbolic, and elliptic geometries, Logarithmic Spirals and Projective Geometry. M.C. Escher was mind-bending art of mathematical perfection. Escher's inner visions connected him to complex ideas of mathematics and physics in artistic manner or representation. Escher has used multiple elements of physical reality: earth, water, sky, fauna, flora. Escher has created otherworldly optical illusions. His interlocking figures, shapes and mirror images, presented in black and white, have the role to enhance their implausible dimensions.

Escher's artwork is full of duality work between the natural world and his imaginative vision. His art is generated from complex and abstract ideas. Escher used art to represent mathematical concepts, often using unusual perspective and viewpoints: stair that seems to simultaneously ascend and descend, a waterfall that flows uphill, and hands that draw themselves. Many of Escher's paintings explore a tension between the confined figure and infinite space. As a philosophical speculation, it's aware that good

and evil remain in eternal and unresolved tension. It is famous his work called Moebius Ants. Moebius Ring (Ants) is formed out of ants walking forever and covering both sides of the ring.

Infinity is not just one divided by zero for Escher. His approach to infinity creates life in it. Humans can only imagine infinity, but never experience it. Escher's challenge was to capture infinity in a "closed" composition so as to give the observer some feeling of what infinity looks like. He sought to "capture" infinity by means of regular division of a plane, or by reducing the size of some basic configuration.

For example, in "Circle Limit III", infinity is demonstrated by outward size reduction. The fishes keep diminishing, each time to half their preceding size, where a circle encloses an infinite number of fishes. "Circle Limit III" may also be looked upon as a wonderful demonstration of fractals. Thus, Escher may be also regarded as the first "fractalist", another example of how art serves to illustrate scientific concepts, something not so readily comprehended. The work named "Whirlpools" represents two nuclei with tiny infinitesimal figures. The two rows of fishes are swimming head to tail and moving in opposite directions, undoubtedly suggesting the complete range of infinity, i.e. from minus infinity to plus infinity.

Escher can be rightly called surrealist due to impossible objects imagined and created. An example is "Double Planetoid" or double tetrahedron (1949). Two regular tetrahedrons, piercing each other, float through space as a planetoid. The light colored one is inhabited by human beings who have completely transformed their region into a complex of houses, bridges and roads. The darker tetrahedron has remained in its natural state, with rocks, on which grow plants. The two worlds are together and make a whole but have no knowledge of each other.



Figure 8. "Whirlpools" Escher

One of the most popular and interesting works of Escher is the lithography "Relativity". It depicts a world in which the normal laws of gravity can't apply. Is a representation of three-dimensional images in a two-dimensional space.

The architectural structure seems to be the center of an idyllic community. There are windows and doorways leading to park. In the world of Relativity, there are three sources of gravity, each being orthogonal to the two others. Each inhabitant lives in one of the gravity wells, where normal physical laws apply. The structure has six stairways, and each stairway can be used by people who belong to two different gravity sources. This creates interesting phenomena, such as in the top stairway, where two inhabitants use the same stairway in the same direction and on the same side, but each using a different face of each step; thus, one descends the stairway as the other climbs it. This popular work of Escher has been used in a variety of ways, as it can be appreciated both artistically and scientifically.



Figure 9. "Double Planetoid" Escher (1949)

What about Picasso? His works are art or optics? He is one of those who launched the art movement known as Cubism and produced 3D images in 2D space.

Of course, the string of personalities from the art often associated with science and vice-versa can continue. They were extraordinary minds, difficult to understand for ordinary people who, most often, have provided discoveries for over a hundred years before.

The sculpture named "Endless column" of

Romanian sculptor Constantin Brancusi is for us and for humanity a symbol. Looking to this endless column anyone can understand that science ends where the pure art begins and each other. In this case the words are in addition.

6. Science and Art in the Computer Age

I have to say something about "Art and Science through Informatics".

Computer entered increasingly more in our lives over the last twenty years. The programs developed have led to some unspeakable things years ago. Computational Creativity is the sub-field of Artificial Intelligence research, where people study how to engineer software which can take on some of the creative responsibility in arts and science projects. Example of such project: "The Painting Fool" is a computer program by title of aspiring painter. This program was designed in 2001 to recognize human emotions and to reproduce them through graphic creations, artwork image, the so-called "Machine Vision and Computer Graphics".

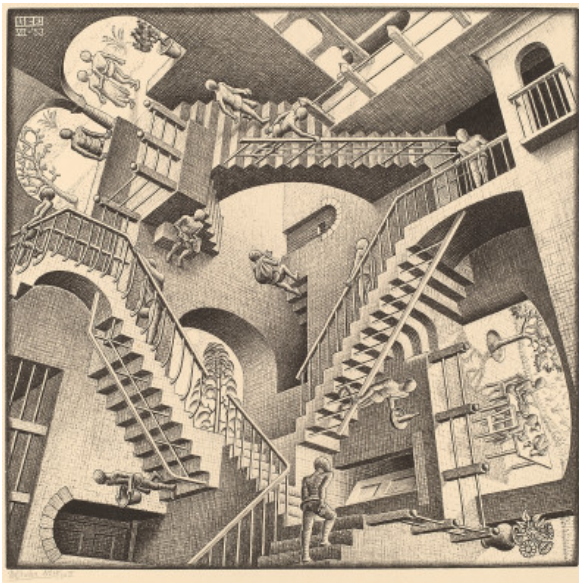

Figure 10. "Relativity" Escher (1953)

I point out examples of output of Computer-Science, Computer-Graphics, Computer Design, Computer-Art: Hyperbolic Patterns - These models are drawn in the Poincare circle model of hyperbolic geometry by Computer, ArtMathic - Modular Graphics Synthesizer - realized Confined Figure and Infinite Space by Computer Programs.

Such projects have several advantages: animation, 3D models in a virtual world,

increased abilities to create meaningful collages which illustrate news stories. The big disadvantage is that people are living increasingly longer in a virtual world, away from nature and create their own world in and by the computer.

New jobs occurring such as: computer musician, computational artist, digital sociologist, artist and researcher in Artificial Life, or new concepts as: digital art, artificial life simulation, cybernetic concept of ecosystems (artificial ecosystem). Do people prepare to live on another planet? Here are some examples of programs with this theme, very complex, including both science and art: future space-based ecosystems, Utopia innovative artificial ecosystem, The Potential of Synthetic Biology in Space. Future Hybrid Ecology is the complete integration of art and science in our life.



Figure 11. The Endless Column by Constantin Brancusi

Last but not least should be noted "Robots Design" that involve a lot of science, engineering computer and as much art.

Very interesting are applications of mathematics and computer in drawing fractals, which often can be considered works of art. Fractals start

with a process called iteration. An operation is repeated over and over again. Modeled fractals may be: digital images, electrochemical patterns, illustration, sounds, trees, ferns, cells of the nervous system, crystals, various vegetables (cauliflower and broccoli). Doing "Mathematical Fractal Art" means to create and explore new complex algebraic expressions which generate imagery never before seen by human eyes.

Also I have pointed out the powerful but dangerous role of the computer as "Learning Resources".

Future world will be 100% VIRTUAL? Many people express concern about this but more and more are the ones that create increasingly in the virtual domain. It is extremely dangerous. We risk, at a time, that the new generation to know only the virtual world, not observe the real world.

In these conditions it has become a question from Albert Einstein's Affirmation: Imagination Is More Important than Knowledge? Now it is the time to secure our future.

7. Some ideas on education for knowledge using both science and art (Art of sciences and science of arts)

I am sure that in many cases we can say: "Hands-on Science by Art" as well as "Hands-on Art by Science".

It's good that our students to know/learn during education, at least all those related above.

Teachers of science: mathematics, physics, chemistry, biology are fascinated by the universe of science and dedicated their entire existence to unimaginable beauty of a formula derived by calculations and assumptions in entire nights. The same way arts servants are fascinated by combining color science, poetry, writing, declamations, musical notes, words and reality of the mysteries of nature. Both sides express in a way what they saw in nature but why not show as a whole?

I suggest some ideas in this sense to the three stages of development: the youngest "researchers" in art and science (kindergarten), children aspiring to artists or scientists, adolescents almost formed.

Knowledge by Science and Art at very early age: In kindergarten we can use boards, sheets, coloring books with drawings that can give different explanations about: fauna, flora. On these models we can give topics to create plants and animals from plasticine, may be colored with

watercolor.



Figure 12. Study of PreHistoric Animals and Reptiles by plasticine



Figure 13. Study of PreHistoric Animals and Reptiles by colored with watercolor

Educative can be play areas, with pieces designed on educational themes, with abstracted forms from nature, involving science and art (eg. Denmark).



Figure 14. Play area for kids in Denmark

A lot of LEGO games and puzzles can develop children's imagination and creativity.

It is recommended that primary school pupils to

read Jules Verne to which we have sunk to the "Center of the Earth" to spend then "Five Weeks in a Balloon" or make "Around the World in Eighty Days" with "Captain Nemo" or to travel "Twenty Thousand Leagues Under the Sea". Surely develop their imagination. At this age they have to visit museums, to experiment in physics, chemistry, biology, learn to play different musical instruments. Also children should be conducted using the computer to develop imagination, attention, skills, knowledge of science by lessons, documentation, Computer Games, video Games, Matrix etc.

Easy Ideas Combining Science and Art (primary and gymnasium)

Theme: Pendulum Painting

Science objectives: gravity, force and motion, pendulums

Art objectives: symmetry, viscosity

Reasons: Science can be fun and art can be meaningful. You don't need to be an artist or have a classroom of expensive supplies to create art integration that is fun and purposeful.

Summary: The motion creates a symmetrical splatter. Different mediums can be experimented for viscosity testing. Students learn about the effect of gravity, the movement of a pendulum, and how different forces act. Try the project several times with different swinging speeds and rope lengths, graphing the results.

Theme: Good Vibrations

Science Objectives: sound waves, vibrations

Art Objectives: music vibrations

Reasons: Art isn't just about visuals! Music can lend some fun to your science routine. Music is an art form whose medium is sound and silence. Its common elements are pitch (which governs melody and harmony), rhythm (and its associated concepts: tempo, meter, and articulation), dynamics, and the sonic qualities of timbre and texture.

Summary: Take a small plastic or paper cup and put a tight lid of aluminum foil on top. Hold it in place with a rubber band and then spread salt or sugar granules on the surface. Students make different sounds with instruments, clapping their hands or using their voice near the cup (but without blowing air on the surface). The salt will jump in response to the vibrations. Student will notice bigger jumps for louder and lower sounds. It will even "dance" when near a loud speaker. Students can actually see the vibrations made by

sound waves. In physics, a wave is a disturbance or oscillation that travels through space time, accompanied by a transfer of energy. Wave motion transfers energy from one point to another, often with no permanent displacement of the particles of the medium—that is, with little or no associated mass transport. They consist, instead, of oscillations or vibrations around almost fixed locations. Waves are described by a wave equation which sets out how the disturbance proceeds over time. The mathematical form of this equation varies depending on the type of wave.

Theme: Insect's habitat

Science Objectives: arthropods, insects, metamorphosis, habitats, reading diagrams

Art Objectives: models, materials

Reasons: children need to know the surrounding world through models, by hands-on. Insect experiments for kids are an excellent way to learn about the natural world. A number of creepy, crawly bugs are outside your door, in your house, or available at the store, waiting for kids' observational skills to take root. Not only will they have fun, kids will learn a ton too.

Summary: Introduce insects and arthropods with an interactive website, and students identify their main parts. Then we look at field guides and online images of different insects. Try to have real insects in viewing boxes or under the microscope for a close-up look. Then students create an insect out of Model Magic or other clay. Student must have the necessary parts to get a grade for the project, but allow their colors to be whimsical. Finally, they create realistic backgrounds out of box lids or 2-liter bottles with the bottom removed. We display the insects in the hallway with insect trivia.

Later, in high school we can develop themes as:

- "Music between Science and Art" (design and construction of instruments, composing music, musical notes, vocal or instrumental interpretation)
- "Integrating Art and Thinking" (which allow an opportunity to hone both their thinking and artistic skills)
- "Discovering Science through Art Experiences" (topics covered are water and air; light and sight; motion and energy; reaction and matter; and nature and earth)
- "Science and Art of Visualizing Information"

- “The Power and the Beauty of Diagrams” (Computer Graphics and Mathematical formulas)
- “Einstein, Dali and Time” (cruel, pitiless, heartless crossing of time)
- “Dali's and Einstein's Relativity” (At the speed of light, length shrinks to zero while mass and time approach infinity)
- “Geometry and Escher” (impossible and surrealist geometrical constructions)
- Physics and art in connection with reality - two apparently different directions but with the same final purpose
- “Abstract and concrete in science and art”
- “Sound in Physics and Music”
- “The musical instruments and Physics”
- “Colors in physics and art” or “The Science and the Art of Colors”
- “Architecture means art, engineering and physics”
- “Living Space by Computer Programs”
- “Science and art in restoration of architectural monuments”
- “The light in our house”
- “Photography, painting, film are visual art or science?”
- “Physics in the Literature”
- “Sculpture, between Art and Science”
- “Painting and optical”
- “Art, science and technology in popular domestic objects”
- “Jewels, the result of art and science”
- “Shows and acoustic of show rooms means science and art together”
- “About Physics in Science-Fiction Literature”
- “Sounds and Electronic Music”
- “Mathematical Fractal Art”
- “Contributions of computer programs to integrate sciences and art”
- “The Photoshop - the program of Science for Art”

A smart magician would take lessons from nature: for example the golden ratio and Fibonacci number, the universal law in which is contained the principle of all beauty and harmony, are just a consequence of natural science and art working together (Fibonacci or Leonardo of Pisa, 1170-1250). So, be a magician, create a parallel dimension where both science and art could touch, and the illusion of perfection would be completed.

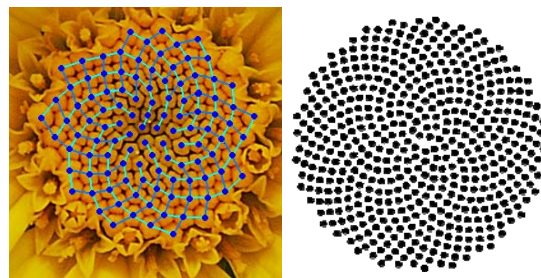

Figure 15. Sunflower Models - arrangements involving consecutive Fibonacci numbers

8. About the role of Comenius in-service training for teachers

I got in touch with these new, European methods of understanding and approaching the reality through the common tools of Science and Art by my participation in-service training for science teachers: “Science and Art - So Different, So Similar!” (2011, Santiago de Compostela, Spain).

The main purpose of the course is to provide participants with ideas, issues, which they may use in science classes, to give students the idea that science and art are, in a profound sense, a similar thing though, at first sight appear to be two totally different areas. Methodology of the course focused on the use of the ability to communicate and address issues about different forms of art but mostly about their relationship with science. The course alternated presentations, lectures and exhibitions of European teachers, recognized internationally, tours and thematic visits with scientific, cultural, artistic and ecological purposes and workshops in mixed groups.

In the presentations, lectures and exhibitions were addressed topics such as: painting, music, architecture, literature, physics, mathematics, biology, chemistry, computing, urbanism and ecology, everything from relationship perspective science-art.

We visited the Park for Renewable Energy and The Museum of Energy in Sotavento, a new concept of wind park that brings together aspects of technology, scientific, ecological, artistic, commercial and educational.

I appreciate and recommend this course, for the perspective offered to study and explore similarities between science and art, for the professionalism of lecturers who have confirmed topics of the course, also as a "trip", incursion, cross the limits of arts and sciences and also for the opportunity to know the values of cultural

European heritage. The course provides identification of skills at European level, the ways in which they can be learned, practices and solutions, tested at European level, to adapt students, teachers and the partners at changing society. Lecturers gave us new ideas about using the common language of science and art. The course provides broadening cultural horizons by visiting historic sites, through direct contact with the culture, customs and traditions of other European countries. The course promotes education for harmonious, multilateral development of our students.

9. Some conclusions, Some opinions

Art and science are antagonistic or complementary?

Art and science are always in harmony, never are in discordance. Without art, and also without science, humanity could not exist. So varied in purpose, expression and impact! So important to people and society in so many ways! These things are true for science as well as for art.

Almost any object produced by humanity includes and need both science and art. The creativity and products in both cases requires similar mental procedures such as observation, analysis and synthesis, proportional thinking, visual presentation and graphic representation.

As with all things in the real world, science is not always utilized as a high moral force: builds bombs and poisons gardens and forests. Also, art in the public sphere is not always used for the benefit of humanity. More often it is used to promote products or boost conspicuous consumption.

But we need to: Explore, Discover, Creates. Knowledge must be performed through hands-on creation and exploration but integrating art and science. Art can be a tangible means to illustrate Science: artificial human brain, human cloning, metamorphosis, time and space, "Godfather". A painting's unique contribution to society is the same as that of a physical theory or a bio-medical technique. When it comes to imaginative process, however, scientists and artists share thinking tools and talents. Certainly, the best scientists are also artists at heart. The passionate synergism of reason and emotion, analysis and intuition show us that power is all imaginative thinking.

Try today to unleash express children's creativity through integrated science and art and we can change the way to see the world.

Our world might be a better and more enlightened place if all of us dropped the whole supposed left-brain/right-brain theory. Let's open our whole minds to the full realm of human imagination. Say no separation of the world in the art world, the humanities world, the science world. Ultimately we all live in one world and it's worth trying to understand each of the perspectives in it.

There are a growing number of science-art collaborations this era, where artists are brought into the lab to spend time with researchers, and come away inspired to create works that give us not only an insight into science, but also a new insight to ourselves. Supercomputer-generated simulations of fusion energy interactions to high-resolution imaging of the space are been aided by artists to understand an image in an intuitive way, and gain insights that might lead them to better comprehend highly complex problems. Neurobiologists, engineers, geographers and computer scientists, draws together to develop new tools that help visualize complex scientific data and the physical phenomena they measure. These include complex using centuries of experience from art and perceptual psychology.

Art for art's sake and science for the sake of science!? If there is science without art and art without science mean they are not well done!

There are fabulous examples of art contributing directly to scientific advances. Art also plays a vital role in helping the general public to visualize the extraordinary worlds of science, understand complex discoveries and concepts that would otherwise remain a complete mystery. And science inspires artists.

We can write full libraries about science and art. Who can say which is the first scientific paper or the first work of art in human history? It is important that our students to perceive the world and to understand its laws as a whole!

Only Leonardo da Vinci as a painter, sculptor, doctor, engineer, alchemist, poet, all in one, could solve the mystery of science-art symbiosis.

10. Acknowledgements

Thanks to Mr. Manuel Costa for the opportunity he gave us, to participate in Hands-on Science activities, thanks to the organizers from Slovakia and to all partners and initiators of the projects we were involved.

11. References

- [1] http://en.wikipedia.org/wiki/Leonardo_da_Vinci
- [2] <http://www.davinciec.com/leonardo-da-vinci.html>
- [3] http://en.wikipedia.org/wiki/Salvador_Dal%C3%AD
- [4] http://en.wikipedia.org/wiki/M._C._Escher
- [5] http://seedmagazine.com/content/article/the_future_of_science_is_art/
- [6] <http://www.virtualdali.com/>
- [7] <http://www.bgu.ac.il/museum/escher.html>
- [8] www.thepaintingfool.com
- [9] <http://www.descopera.ro/>
- [10] <http://agorayouthclub.blogspot.ro/2012/09/arts-science.html>
- [11] <http://www.cosmosmagazine.com/opinion/art-and-science-just-peas-a-pod/>
- [12] <http://usuaris.tinet.org/klunn/artists2.html>



A STUDY OF ELEMENTARY STUDENTS' MODELING ABILITY AND LEARNING TRANSFER

Jen-Chin Lin, Chien-Liang Lin,
Fu Yi Shieh

National Kaohsiung Normal University,
Nan-Jeon Institute of Technology
National Yangming Municipal Junior High
School
Taiwan

jclin@nknuc.nknu.edu.tw
jnlnlin@gmail.com
lkksfe@ms47.hinet.net

Abstract. *This research intended to explore the elementary school students' characteristics of modeling ability and learning transfer, and analyzed the efficiency of concept learning transfer as well as teaching processes. According to the modeling-based inquiry teaching strategies, the researchers designed four teaching units for elementary school 5th grade students to do the modeling inquiry. This science inquiry involves four units: electrostatic, thermal expansion, light reflection and atmospheric pressure. In the quantitative study, the research takes analysis of Repeated*

Measures to explore the whole performance of 30 elementary school students' modeling ability of the lateral and vertical transfer of learning. This study also employed qualitative analysis. The data collection includes learning sheet, classroom observation, video recording. It is based on the classification of concept and analysis indicators of modeling ability. Next, consider the ability of elementary school students, to build capacity analysis indicators in order to evaluate the level of the measure of each student's modeling ability. The results shown that it is appropriate to separate the ability analysis indicators of elementary school students into 5 levels, the learning transfer of scientific understanding was more obvious, but on the lateral aspect, the learning transfer of modeling abilities was more slowly. Ordinarily, the effect of the learning modeling was influenced by teachers' guidance on processes of modeling inquiry.

Keywords: Modeling Ability, Modeling-based Inquiry, Transfer of Learning, Teaching Processes.

1. Introduction

Scientific model, the key to understanding the natural world, is an application between theory and concept. Over the past decade, models and modeling have gradually been recognized as an important approach to science learning objectives (Giere, 1991; National Research Council [NRC], 1996). The research points out that one of the critical approaches is the scientific modeling to achieve the goal of science learning (Justi & Gilbert, 2002). The NRC (1996) indicates that models have many forms, including physical objects, plans, mental constructions, mathematical equations and computer simulations. Based on previous assumptions, the researcher concluded three kinds of models, including object model, conception model and mathematical model (Lin & Hung, 2011). Modeling is a kind of inquiry and modeling learning can enable students to share their models and their perspectives. Nowadays science education focuses on scientific inquiry frequently. teachers commonly use models to explain ideas to students (Duit 1991).

For junior high school students, they can explore science knowledge and cultivate the ability of thinking, if we adopt the course which is based

on Model-based Inquiry. However, for elementary school students, this method has yet to be developed and verified.

In summary, the purpose of this study is that the assessment of elementary school students the ability to model and explore elementary school students the ability to model the transfer of learning situation, as well as modeling the process of teaching. Therefore, this study investigates the questions include:

- What are indicators of analysis of elementary school students' scientific modeling ability?
- How are the effects of learning transfer of elementary school students' scientific modeling?
- Which are the teaching processes of elementary school students' scientific modeling?

2. Overview of MIT and learning transfer

Current experimental courses in schools, teachers always conduct recipe-type experiments, but they rarely conduct thought experiment (Lin, 2012). This research believes that not only emphasis hand on doing science but also mind on thinking activity. Therefore, only when the outcomes of this mental activity seem successful that actual empirical testing takes place, where this is possible.

2.1. MIT mode

The MIT (Modeling-based Inquiry Teaching) mode is according to the framework of MCSI teaching mode (Lin & Hung, 2011), which includes four phases in the teaching, "Question & Analysis", "Prediction & Experimentation", "Explanation & Interaction" and "Synthesis & Application" (show on the Fig.1).

To MIT teaching model can be applied to elementary school students, the modeling process can not be too complicated, this study revised four stages, including: 1. initial model, 2. model construction, 3. model revise, 4. model application.

Based on social constructivism, the goals of the phase of "explanation & interaction" are that the teacher conducts students to explain and to discuss their models. Through this phase, students can share their models and perspectives. In this way, students can learn more about scientific knowledge and method of

argumentation.

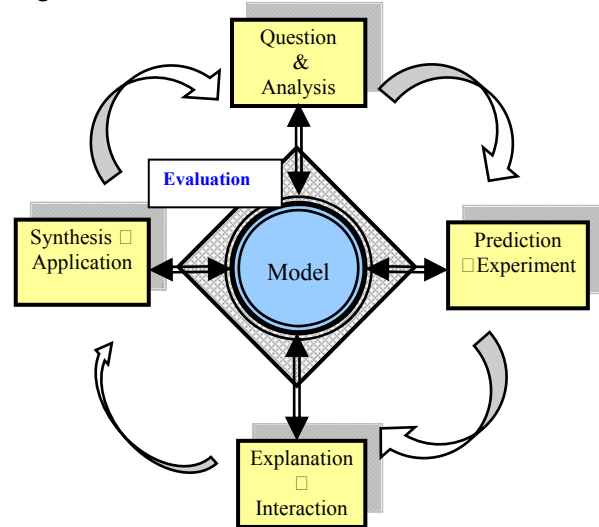

Figure1. The framework of MIT mode (modify from Lin & Hung, 2011)

The core of the four phases is to construct the model and the teacher evaluates students' performance in each phase. According to students' opinions and suggestion from others, the teacher realizes their perspectives and then conducts them to discuss their models. Finally, the students gradually accept and establish the correct model like the scientist. To analyze the modeling processes, research always concerns about the cooperation and competition modeling teaching (Clement, 2002).

2.2. Learning transfer

There are two types of "learning transfer". One is "vertical transfer" and the other is "lateral transfer". People take their previously experiences to solve similar and identical problems. For instance, the questions in the same unit have the same characteristic things and analogous conception. Students apply the concept they have and learned to solve the similar problems. That is "vertical transfer". Combine the methods of problem solving and the conceptual knowledge to solve the more complicated problems and it forms more advanced learning than previously experience. This way of learning transfer makes the learners improve their learning ability and use the knowledge they having to solve new problems. For example, learning of theory and Modeling-based Inquiry, both of them combine two or more than two concepts and induce some relationships or patterns of knowledge. By doing so, the learning combines theory and conception

and cross new knowledge. This way of learning is “lateral transfer”.

3. Research method

This study employed qualitative and quantitative methods.

3.1. Experimental design

The participants of pilot study are 30 in 4-6th grade elementary school student and the goals were to develop the Analytic Index for modeling ability assessment and learning sheet. Then, the formal study also is 30 participants in 5th grade elementary school student. Both two classes were taught with MIT teaching mode by the same teacher who is an Elementary School science teacher more than 30 years. By the way, he has a doctorate in science education and has published two papers about models and modeling, well versed in science teaching, as well as in the MIT teaching mode had good communication with researcher.

Modeling inquiry teaching sequence, in accordance with of Electrostatic, Thermal expansion, atmospheric Pressure and Light reflection. Two hours per week teaching activities, each unit for two weeks, a total of 8-week course.

3.2. Research tools

To finished the purposes and answered the questions, this research developed some tools including, learning sheet, Modeling Ability Analytic Index and learning effeteness questionnaire.

3.2.1. Learning sheet development

Learning sheet can guide the students have a clear tasks and the students are asked to complete their learning tasks based on a printed learning sheet after listening to the teachers' instructions. But it can not cause the imagination and creativity restrictions, to students drawing can lead to students' ideas, as well as the mental model. Finally, the establishment of an analysis of indicators, the MIT can based on the learn Sheet to assess the effectiveness of learning.

- 1). Predict the result of the experiment.
 - a. Your predicted :
 - b. Because

- 2). After being the experiment, record the phenomenon.
- 3). Moreover, compare the phenomenon students observed in the experiment with the prediction at question number one, and illustrate opinion in each term.
- 4). After discussing with teammates and being guided by the teacher.
- 5). Explain the reason why the balloon inflates when the candle is burning? Explain and illustrate the phenomenon that the balloon will be inflated while the candle burning in your terms.

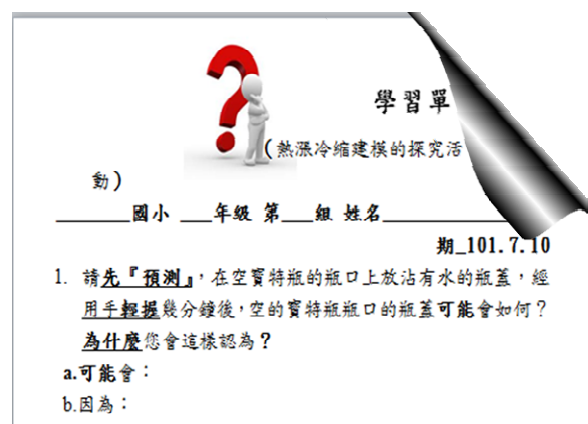

Figure 2. Modeling-based inquiry: Expansion and Contraction

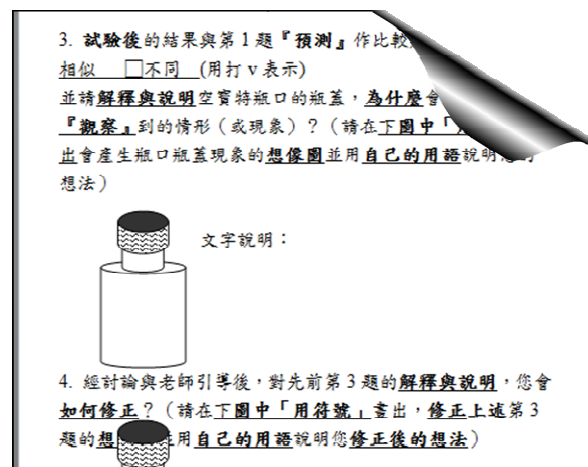

Figure 3. Experiment, comparison and modification

In order to assess elementary school students' modeling abilities, we must consider the ability of students, the levels of the Analytic Index can not be too much. So, reference scholars define the Modeling Ability Analytic Index (Biggs & Collis, 1984; Vosniadou, 1994), and decided five levels in each modeling process, as shown in

Table 1:

- Level 0 □ No response.
- Level 1 □ Replying an intuitive experience.
- Level 2 □ Replying within self-experience more than scientific knowledge.
- Level 3 □ Replying within self-experience less than scientific knowledge.
- Level 4 □ scientific model

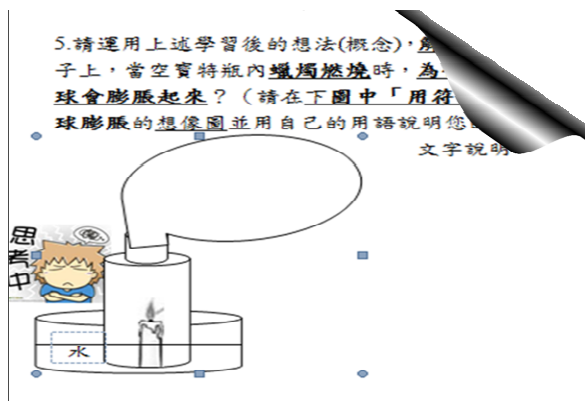

Figure 4. Explanation, reflection for concrete model

3.2.2 Modeling ability analytic index

The elementary school students Modeling Abilities Analytic Index separate into 5 levels, then based on the 5-point Likert Scale to set up the Analytic Index shown in the table 1. Waiting for the completion of each unit and according to the Analytic Index table, the two experts begin to assess the learning sheet. Therefore, the researcher can counts of the effectiveness of the learning transfer as well as calculate the inter-rater reliability assessment by equal to 0.822. Modeling Abilities Analytic Index - take the activity of Expansion and Contraction as example. “Please predict the result of the experiment. Dip the rim of a bottle in water and hold the lip of the bottle for some minutes. What will you see ...”

3.2.3. Learning effectiveness questionnaire

To survey the elementary school students' viewpoint of models and modeling, the questionnaire is divided into six items:

- 1) To understand the model is an important tool to explain the phenomenon of nature.
- 2) To understand the people can Use a variety of models as a scientific prediction.
- 3) To understand the people can use the “non-single model” to explain the science.

- 4) To realize the "Model selection" is based on the support of the theories and facts.
- 5) To realize that model has the function of explanation.
- 6) To believe that “creation of model” has duration and temporality.

	1. Initial model prediction	2. Model construction
Level0	Don't know Can't do Can't find	Don't know Can't do Can't find
Level1	The cover will move.	Gas will be washed out and the cover will move.
Level2	Temperature Hands temperature	Cold and hot Temperature
Level3	Hands temperature causing move.	Thermal Expansion and Contraction
Level4	Hot causing Expansion and Cold causing Contraction	Thermal Expansion and Contraction, causing the substance to expand

Table 1. Modeling ability analytic index

3.3. Teaching processes

The teacher leads his students to do “Modeling-based inquiry” by learning sheets step by step when they are doing activities of each unit. Based on the aforementioned MIT, teacher will invite each team to draw a diagram (Mental model) on the blackboard after students discussing at the phases of explanation and communication. Then, the teacher will appoint each team to illustrate the diagram and everyone focus their eyes on the speaker. Moreover, students in the same team will bring up some questions and debate to each other in order to figure out the main conception of science. In the teaching process, we should follow the MIT's teaching mode and take the model as a core. Teacher's job is to timely questions and guide students to think deeply. When the idea of each group there are contradictions that is the best opportunity to promote students' thinking. Allow students sufficient rebuttal and argument, so the students can clarify the problem step by step and ultimately to establish the correct model.

4. Research result and discussion

The result of this research included students' modeling ability and learning transfer, and analyzed the efficiency of concept learning

transfer as well as teaching processes.



Figure 5. Each team to illustrate the diagram and explanation and interaction



Figure 6. Teacher encourages students to do the explanation and competition

4.1 Efficiency of concept learning transfer

There were four units as the teaching activity, The Table 1. the "Teaching Units" column. A as Thermal Expansion Experiment, B as Atmospheric Pressure, C as Light reflection and D as Electrostatic.

The results of post comparison with LSD, and all of teaching units shown the phase4>phase3>phase2>phase1. These displays the learning transfer of scientific understanding was more obvious.

4.2 Efficiency of modeling ability

The results of post comparison with LSD, only shown Unit 3> Unit 1, Unit 4> Unit 1 and Unit 4> Unit 2. These shown the learning transfer of modeling abilities was more slowly. Modeling learning will not be effective immediately, it is slow progress. Such an outcome with Justi and Gilbert (2003) same viewpoint.

4.3 Teaching process in explanation and interaction phases

In order to understand the MIT teaching

processes, the Learning pathway Discussion of modeling and UciNet was used in qualitative analyses. The researcher activity, Accretion mode: Teacher guide students to accrete the model step by step, but in this research the variables are reduced by the cooperation modeling-reduction mode.

Teaching Units	Sum of Squares	df	Mean Square	F	Sig.
A	1038.408	1	1038.408	1318.373	***
B	1074.008	1	1074.008	1102.847	***
C	1184.408	1	1184.408	1872.667	***
D	1267.500	1	1267.500	1986.892	***

*** p<.001

Table 2. Summary of concept learning transfer

Source	Sum of Squares	df	Mean Square	F
Intercept	18204.033	1	18204.033	2801.116***
Error	188.467	29	6.499	

*** p<.001

Table 3. Summary of modeling ability learning transfer

5. Conclusions and recommendations

5.1. Conclusions

The effect of modeling-based inquiry teaching is divided into two aspects to discuss. On the vertical aspect, the learning transfer of scientific understanding was more obvious, but on the lateral aspect, the learning transfer of modeling abilities was more slowly.

A drawing allows students to show their thinking of mind more concretely. Besides, teachers can observe the realization of students by diagrams and guide them to create a correct concept and model step by step.

On Quantitative and Qualitative Analysis, the effect of the learning modeling was influenced by teachers' guidance on processes of modeling inquiry, especially the phases of explanation and interaction.

5.2. Recommendations

Modeling inquiry teaching should pay attention to teachers to guide the interpretation and communication phase, therefore, it is recommended that new research can further

explore the characteristics of argumentation in the interpretation and exchange phases to enhance the effectiveness of learning transfer of modeling.

In the new study to further explore the interpretation and exchange phase to strengthen the strategies of guided reflection to promote the learning of the modeling abilities.

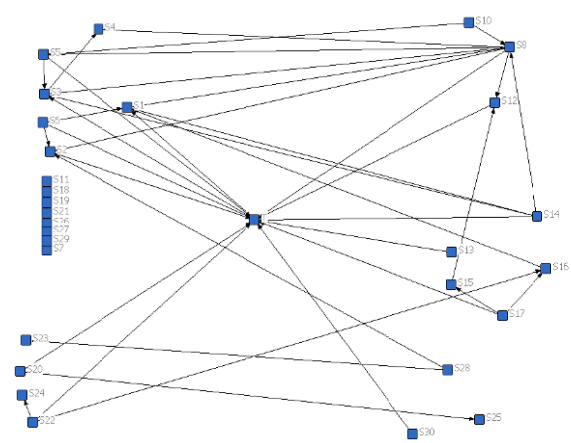

Figure 7. Teaching Process in explanation and interaction phases. (Ex. Learning activity of “expansion and contraction”)

Acknowledgments

This study is supported by the National Science Council, Taiwan, under contract numbers NSC 101-2511-S-017-003-MY2

References

- [1] Biggs JB & Collis KF. (1982). *Evaluating the Quality of Learning: the SOLO taxonomy*. New York: Academic Press.
- [2] Clement J and Steinberg M. (2002) Step-wise evolution of models of electric circuits: A "learning-aloud" case study. *Journal of the Learning Sciences* 11(4), 389-452.
- [3] Giere R. (1991). *Understanding scientific reasoning*. Orlando, FL: Holt, Rinehart, and Winston, Inc.
- [4] Justi R & Gilbert JK. (2002). Modeling, teachers' views on the nature of modeling, and implications for the education of modelers. *International Journal of Science Education*, 24(4), 369-387.
- [5] Justi RS & Gilbert JK. (2003). Teacher's view on the nature of models. *International Journal of Science Education*, 25(11), 1369-1386.
- [6] Lin JC & Hung JF. (2011) A Study of Modeling-based Teaching with Computer Simulation Inquiry. NARST 2011, Orlando, FL, USA.
- [7] Lin JC. (2012) A Study on Enhancing the Thought Experiment in Modeling-Based Science Teaching to Improve the Learning Effect. *NARST Annual International Conference*, Indianapolis, Indiana, USA: March 25-29, 2012.
- [8] National Research Council [NRC]. (1996). *The national science education standards*. Washington, DC: National Academy Press
- [9] Vosniadou S. (1994). Capturing and Modeling the Process of Conceptual Change. In S. Vosniadou (Guest Editor), Special Issue on Conceptual Change, *Learning and Instruction*, 4, 45-69.



EXPERIENCE WITH THE IMPLEMENTATION OF INQUIRY-BASED ACTIVITIES ENHANCED BY DIGITAL TECHNOLOGIES AT ONE OF THE SLOVAK GRAMMAR SCHOOLS

Veronika Timková¹, Zuzana Ješková¹,
 Mária Horváthová²

¹Faculty of Science, University of P.J. Šafárik in Košice, Slovakia

²Grammar school, Košice, Slovakia
 nikafek@gmail.com, zuzana.jeskova@upjs.sk,
 horvathovam@gmail.com

Abstract. *The currently running educational reform in Slovakia has brought many changes concerning the organization of education as well as its content. Concerning the content, in science education, in particular, the main attention is paid to scientific inquiry with emphasize to the students active independent learning. In order to fulfil the new goals in science education students should work more independently being in the role similar to that of a scientist carrying out inquiry activities. This requires also new approaches from the teacher who needs to be educated in the field of inquiry-based science education (IBSE). Except from well-educated teacher IBSE requires much time to carry out activities with strong emphasize on students'*

independent work. However, this is in contrast to the current dramatic decrease of number of compulsory science lessons. The paper describes experience from implementation of inquiry activities at a grammar school within a special physics-informatics interdisciplinary course created within a school curriculum. The developed inquiry activities are enhanced by digital technologies such like datalogging, videomeasuring and modelling tools and there is the first feedback from the use of the developed activities in teaching described.

Keywords. Inquiry-based science education, inquiry skills, digital technologies, datalogging, videomeasurement, modeling, physics teaching

1. Introduction

The currently running school reform in Slovakia has brought significant changes concerning the content, extent and the way how science is taught. Concerning the content, in science education, in particular, the main attention in curriculum [1] is paid to the scientific inquiry with emphasize to the students active independent learning. In order to fulfil the new goals in science education students should work more independently being in the role similar to that of a scientist who formulate a problem, design an investigation, carry out experiment, collect and analyse data, create models and draw and discuss conclusions. This requires also new approaches from the teacher who needs to be educated in the field of inquiry-based science education (IBSE). Except from well-educated teacher IBSE requires much time to carry out activities with strong emphasize on students' independent work that also needs working in small groups. However, on the other hand, the number of compulsory science lessons has dropped dramatically with a number of about 30 students in the class. As a result, science teacher has a dilemma: he is obliged to do inquiry but does not have conditions for this within the state curriculum.

2. Slovak state and school curriculum in physics and its potential towards IBSE

The content of the upper secondary schools (grammar schools) (ISCED 3A) [1] is divided into 7 educational areas including: Language and communication, Mathematics and information, Man and nature, Man and society, Man and values, Arts and culture, Health and movement.

The subject of physics (chemistry and biology) is a part of the area named Man and nature. The main objectives in physics education are determined within 6 areas, namely World around us, Communication, Science knowledge and ideas, Scientific inquiry, Data processing, Experimentation. In each area there are concrete goals specified that should be achieved at the end of the course. The last three areas clearly identifies different elements of IBSE (tab.1)

<p>Scientific inquiry</p> <ul style="list-style-type: none"> ▪ to formulate a problem, research question, that can be answered by experiment, ▪ to formulate a prediction, ▪ to test a prediction, ▪ to plan an appropriate experiment, ▪ to formulate a conclusion according to observation and experimentation, to comment on measurement errors, ▪ to formulate the validity of conclusions based upon a series of measurements, ▪ to evaluate the overall experiment including the procedures used in it.
<p>Data processing</p> <ul style="list-style-type: none"> ▪ to organize, present and evaluate data in different ways, ▪ to transform data presented in a form into another form (including calculus, tables, diagrams), ▪ to identify possible trends in data, ▪ to create predictions based upon data, ▪ to suggest conclusions based upon data, ▪ to use knowledge to explain conclusions,
<p>Experimentation</p> <ul style="list-style-type: none"> ▪ to follow written or oral instructions, ▪ to select and use safely the experimental setup, materials, technology appropriate for measurement, ▪ to carry out the experiment safely, to record data gained by observation and measurement, ▪ to use appropriate tools and technology to collect data.

Table 1. Elements of scientific inquiry included in Slovak curriculum in physics

The physics teaching is organized the following way. Within the state curriculum the teacher can use altogether 5 lessons (2,2,1,0 lessons per week during the 4-years study). There are about 30 students in a class. The classes may be divided into two halves for science lessons but at many schools this is not done. As a result, to fulfil the goals of the state curriculum is not an easy task. The inquiry activities are time consuming and taking into account the conditions that teachers

have for meeting the educational goals they very often teach the traditional teacher-centred way with emphasize on the content knowledge of their students.

There are several ways how to overcome this problem in order to change the traditional way of teaching to more student-oriented with emphasize not only on the content but also on inquiry skills development. Except from the state curriculum the school can create its own school curriculum in two ways.

Within the school curriculum the number of compulsory lessons can be increased by additional lessons. However, this strongly depends on the school priorities and the willingness of the school management towards these changes. Another way is to create new subjects in order to design their goals, content and organization within the school curriculum. Such specific subjects can also support the school priorities in order to attract students to the school by its dominant focus of interest (e.g. scientific literacy or languages, etc.).

4. Implementation of inquiry-based activities in the framework of the new interdisciplinary science course

One of the grammar schools in Košice, Slovakia, has decided to design a new course that would support scientific literacy of their students. This is a result of their long-term effort in the field of mathematics education support that they tried to extend to other sciences, as well. Within the school curriculum there has been designed and developed an interdisciplinary subject involving mathematics, informatics and physics with a number of two joined lessons per week for half of the class aimed at students in the first year of their study at the grammar school (aged 14-15). The main goals of the subject involve developing inquiry and digital skills using ICT in physics and programming skills in the field of informatics. The physics lessons are alternating with the programming lessons, so that half a class experience the physics part once in two weeks. The activities were developed in order to complement the topics of regular physics lessons that include mainly mechanics. The lessons were carried out in a computer lab equipped with the COACH6 system [2] that supports the use of datalogging, videomeasuring and modelling tools. Over the course students carried out inquiry activities at different levels of inquiry in order to enhance conceptual understanding and

developing inquiry skills, mainly in the field of doing investigation and modeling. After experiencing different lower levels' inquiry activities students were asked to carry out an open inquiry activity in a way of a research project.

5. Examples of activities

The activities developed for the course were created at different level of inquiry, mainly at interactive demonstration, guided discovery and guided inquiry level [3,4]. The activities students carried out were adapted from the existing activities offered by the COACH system [2] or there were new tailor-made activities developed. Students' independent work was supported by the worksheets with instructions. The role of the teacher was to facilitate students learning.

5.1 How does a toy car move?



Figure 1. Student experimenting with the toy car

The main goal is to find out how the real motion of a toy car is represented in position and velocity graphs. The experimental setup of a toy car with an ultrasonic motion detector was situated in front of the whole class. Teacher was carrying out interactive demonstrations [5] on a car motion. The students were asked to draw their predictions about the position/velocity graphs for each of the motion. Their prior ideas were identified and then were confronted with the experimental results. The results were analysed in order to point the important features of the graph (tendency, slope, sign, etc.) (fig.1).

5.2 Match the graph

This activity was carried out in a reverse order.

The graph was already prepared and students should walk in order to fit the graph. Students working in groups firstly had a look in the picture in order to analyse the graph and describe in words what the certain parts say about the motion. Finally, students checked their ideas by real experiment when they were moving in front of the ultrasonic sensor in order to match the graph as well as possible (fig.2).

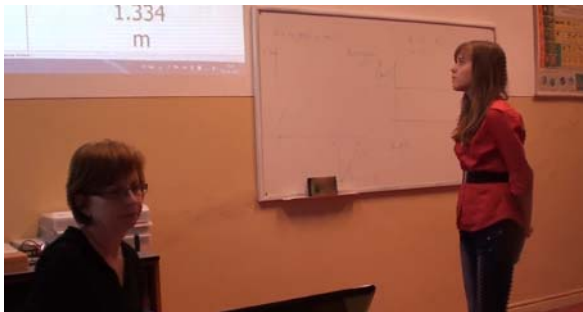

Figure 2. Student moving according the graph

5.5 Model of the bathtub

One of the goals of the subject reflecting to its interdisciplinary physics-informatics approach was to try out activities aimed at modelling of phenomena with the help of computer dynamical modelling tools. In order to do this for situations and processes in physics student were first introduced the idea how the dynamical modelling approach works on a simple activity aimed at the bathtub that gains water through a tap and loses water through a drain. First they learn to create a graphical model of a bathtub with constant water input (output). When they understand the meaning of the state variable and the inflow and outflow representing the speed of water income or outcome they can move on to the next step. They are asked to try to make the model more realistic. In order to taking into account that the outflow depends on the amount of water in the bathtub they modify the model. This is the first experience with modelling so that a lot of teachers help is needed.

5.6 Model of a runner

Having experience with modelling of a bathtub in this is activity students were asked to create the model of a runner. Based on the instructions in the worksheet students first created a model of a runner moving uniformly. In the next step they were expected to create a model of the runner who has just started running. Students modelled

this situation as a uniformly accelerated motion. Students worked in pairs in front of the computer, however all the steps were guided by the teacher who communicated a lot with students asking questions, drawing and comparing predictions about the resulting graph on the blackboard as well as setting the appropriate variables and constants (position, speed, acceleration), flow quantities and connections between the quantities (fig.3). After successful model of uniformly accelerated motion students were asked to modify the model in order to represent the runner who is going to stop.



Figure 3. Modeling the motion of a runner

5.7 Fall of a heavy ball

This activity was divided into two parts when students worked in pairs in front of the computer with the help of worksheets. Firstly they analysed the already recorded video on the free fall of a heavy ball in a guided discovery way. They expected to verify the already known relationships for this kind of motion.

In the second part they created a model of the free fall based on the knowledge gained during the previous activities. Finally they compared results of modelling with the experimental results gained by videomeasurement.

At the end students were asked to do a home assignment to model the raindrop fall considering it as a free fall motion.

5.8 Fall of a light ball

This activity was a guided inquiry activity aimed at discovering the difference between the free fall and the fall of lighter objects in the air. Students measured the position of the falling styrofoam ball in order to find out that the results are different from that of the free fall. They are asked to formulate the reasons for these results in terms of forces acting on the object.

This activity is then followed by modelling this

motion. They have to look at this situation from the dynamical point of view expressing the net force acting on the ball. Concerning the force opposing the motion students are asked to formulate their own hypothesis what the drag force depends on. With a help from the teachers they can verify the hypothesis about the linear (quadratic) dependence on the speed. They check the correctness of their hypothesis comparing the model with the experimental results (fig.4).



Figure 4. Modeling in class

5.9 Research project

After experiencing different lower levels' inquiry activities students were asked to carry out an open inquiry activity in a way of a research project.

The project topic was motion. Students were asked to create their own research question concerning motion of the objects. The research question was supposed to be answered by investigation with the help of digital technologies using datalogging, videomeasurement and modelling tools. At the end conclusions with discussion should be formulated. Students were expected to work in groups of four and they had a month to work on the project.

Here are the examples of the best projects.

5.9.1 Remote-controlled formula toy car

The research question of this project involves the question about the formula car highest acceleration that can be achieved accelerating from the start. Students recorded their own video of formula toy car motion in a gym. They carried out the videomeasurement and the analysis showed $a=2,86m.s^{-2}$ (fig.5).

Following on from this they created a model of motion that was compared with the experimental results finding the appropriate parameters.

5.9.2 Kick the ball

The research question here involves the motion analysis in terms of what happens due to the kick and how the kick in a direction opposite to the motion influences the ball's motion. Students recorded a video of this motion and carried out videomeasurement on this. Then they created a model of motion with velocity change during the ball – leg contact (fig.6). They found out that the horizontal component of velocity is constant on the way there and back with changing size after the kick. From the change of the velocity and the corresponding time interval they estimated the force acting on the ball during the kick (knowing the ball mass).

6. Experience from teaching

During the whole school year we gained a lot of feedback from teaching. We came across a lot of difficulties during the lessons. The main problems concerned the lack of physical background of students and lack of mathematical skills. Even if all the theoretical background was the part of the regular physics lessons, students still suffered from not enough understanding of the kinematics concepts as well as Newton's laws conceptual understanding.

During the activities students were expected to work independently. This seemed to be a problem in many situations. Students still expect detailed instruction and guidance from the teacher. Sometimes their passivity made the whole process slow. A lot of effort was needed from the teacher who tried to make them think and work actively and independently as much as possible. As lessons went on students got more familiar with this way of teaching.

However, on the other hand, when it came to the research projects, students worked quite independently. They were quite enthusiastic and they were even able to divide the work among the group and spent a long time working on the task in order to meet the goals and prepare a final presentation. Nevertheless, there were also students for whom this task was too demanding and they were not able to formulate an appropriate research question and they only presented some partial results of measurements or modelling. It can be seen that the highest level of inquiry is not adequate for all the students. To sum it up, there were about 30% of students who carried out the open inquiry project excellently with all the required inquiry elements. About

80% of students could get data from the videomeasurement and only about 50% of students were able to create a model.

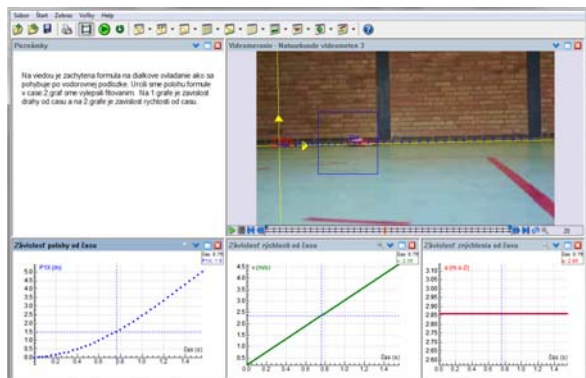

Figure 5. Videomeasurement: Remote-controlled formula toy car

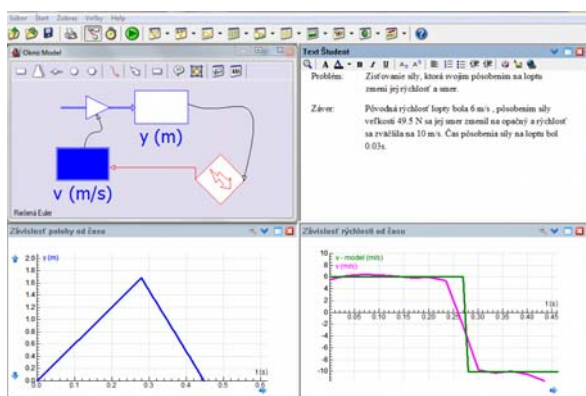

Figure 6. Modeling: Kick the ball

7. Conclusion

In the school year 2012/13 we have tried to develop and implement inquiry-based activities into teaching within a new course of the school curriculum. The teaching was carried out with the first-year students of the grammar school. All the designed activities were aimed at inquiry skills development connected with the abilities to formulate a research question, design an investigation, carry out experiment, collect and analyse data, creating models and draw and discuss conclusions. The evaluation of the whole process show some difficulties concerning with the lack of necessary theoretical background of students. Also, when forcing the students to work independently, they firstly showed some resistance towards this way of teaching. On the other hand, it has been seen that there was a progress as the lessons went on during the school year. Surprisingly, students showed quite a large amount of independence when they had to face

their own group task within the final open inquiry project work.

The positive experience from the course makes us optimistic for the future. We feel that if students experience more systematic IBSE approach not only in a single course but across more subjects they get more familiar with this teaching method and their inquiry skills will be developed to higher level. Using this experience we plan to continue with the course the next school year again taking into account all the feedback that we gained during first run of the course.

8. Acknowledgements

We thank the partners of the international FP7 project Establish (No. 244749), for the motivation towards promoting the idea of Inquiry based science education. This work is the result of the international 7FP project ESTABLISH (European Union's Seventh Framework Programme FP7/2007-2013 under grant agreement n° 244749).

9. References

- [1] National curriculum in physics for grammar schools, ISCED 3, available on <www.statpedu.sk>
- [2] COACH 6 system, available on <<http://cma-science.nl/english>>
- [3] Wenning, CJ. Using inquiry levels learning sequences to teach science, Journal of Physics Teacher education online, 2010, 5(3), 11-20
- [4] Establish project, available on <<http://establish-fp7.eu/>>
- [5] Sokoloff, DR, Thornton RK. Interactive lecture demonstration, 2004 John Wiley et Sons, Inc., ISBN 0-471-48774-0
- [6] Ješková Z et al. (2010) Využitie IKT v predmete fyzika pre stredné školy, Elfa, s.r.o. Košice, ISBN 978-80-8086-146-9, 2010



STUDYING SCIENCE WITH MILK CANDY MAKING

Prof. William Stebniki Tabora

Taller De Ciencia, Montevideo, Uruguay
tallerdecienciauruguay@gmail.com

Abstract. *In 2009 the curriculum of Primary Education in Uruguay suffered a modification through which the contents were segmented by scientific disciplines. With 3500 dairy farms, Uruguay occupies a privileged place in the world, consuming 230 liters of milk per person. All full-time public schools have kitchens where food is prepared for children. Most of the public schools in a single shift and all private schools have heaters and cooking. Therefore, the production of caramel by children attending schools is perfectly possible. Interconnected concepts are included: LIVING-MATTER-ENERGY through classroom research, hypothesizing, experimentation, observation, questioning, predicting, completion and communication.*

Keywords. Inter-multi-transdisciplinarity, matter, milk, science

1. Introduction

In 2009 a new program proposal began in Uruguay. It was made by the Primary Education Council in order to integrate into formal education Early Education Programs, Policy, Rural and Special.

In this framework, the Natural Sciences were organized into disciplines (Biology, Physics, Chemistry, Astronomy, Geology) which different views could be grouped by the inter-multi-transdisciplinarity, which allows: unifying concepts and methodologies, facilitates contextualization, adapt to the integral development of the student, promotes knowledge transference, points to systemic learning and maintains a view that recognizes and sees that there are links between disciplines and solidarities.

The new approach pays special attention to the ongoing interaction between science and society. Knowledge in the area of Natural Sciences are organized and interrelated concepts from three subsumers: **living - matter – energy**. Notions of "diversity-unity", "change", "interaction" and "system" will complement this approach with the

"balance", "transformation", "continuity" and "conservation."

The teaching of Natural Sciences installs question, doubt and generates rank curiosity as a tool, develops hypothetical-deductive thinking, and inductis reasoning by analogy.

The strategy used for the child to develop these cognitive activities are based on: hypothesis, investigation, experimentation, observation, question making, prediction, classroom investigation, drawing conclusions and communication.

This is a progressive teaching role, emancipatory, which places children in educational situations where their knowledge is not sufficient to ensure the conceptualization and construction of thought.

In short, the general objectives in the area of Natural Sciences can be grouped into four main pillars:

- 1) Teaching scientific knowledge that can bring provisional explanations and reflect on the diverse dynamic and changing natural environment.
- 2) Recognizing the non-neutrality of scientific knowledge and its connection with the construction of a systemic view of the world.
- 3) Teaching us to reflect on the scientific and human production, historical and ideological.
- 4) Assessing the scientific methodologies in knowledge production through the introduction of classroom observation, the sequence of experimental models of representation and outreach materials.

1.1. Plan Ceibal

Its name **Conectividad Educativa de Información Básica para el Aprendizaje en Línea** (Basic Information Educational Connectivity for Online Learning) is a project which aims to reduce socio digital division, inclusion and equity in access to education. This means a computer for each child and the mission is to match technology to all children of Uruguay. Became operational in the first half of 2007 and was completed in 2010, where all children in public schools in the country had access to the XO. Many private schools also joined the Plan Ceibal for students acquiring the XO laptops. This made it possible for children to become project participants who gathered information both in their school or

college at home.

The project's operational techniques used guided and structured inquiry.

1.2. Program content of Natural Sciences

1.2.1. Level 3 years: (N3)

Chemistry (Ch): The aggregation states of matter (S and L)

Physics (Ph): The colors. The pigments. Temperature.

1.2.2. Level 4 years: (N4)

Ch: The organoleptic properties of solids (S) and liquids (L) (color, taste, smell). The sieving (method of separation of heterogeneous systems).

Biology (B): Human nutrition: daily intakes, the transformation of food in the body.

1.2.3. Level 5 years: (N5)

Ch: Changes of State of Matter: Melting and solidification. Variation temperature and state changes. Heterogeneous systems: L-L, L-S, S-S.

B: The human dentition.

1.2.4. Level 1: (N 1 °)

Ch: Liquid solutions: L-L, L-S. Decantation.

Ph: Changes in motion. The contact forces.

B: Human nutrition: ingestion, digestion, excretion.

1.2.5. Level 2: (N 2 °)

Ch: Liquid solutions: L-G. Solutions: Solute and solvent. The separation of gases. The filtration. The crystallization.

Ph: Temperature changes produced by different processes: heat and work.

B: Nutrition: food and nutrient, diet, cavities. The digestive system. Mechanical processing of food.

1.2.6. Level 3: (N 3 °)

Ch: Macroscopic properties of matter. Thermal expansion in solids, liquids and gases. Gas compressibility. Chemical transformations: The combustion of organic substances: fuel, oxidizer and products.

Ph: The temperature and its measurement.

B: Organic and inorganic nutrients essential for the proper functioning of the body: the energy requirement of human beings.

1.2.7. Level 4: (N4 °)

Ch: State changes of different substances: evaporation and condensation. Intensive properties of various substances: melting and boiling point. Effect of temperature on solubility. Ph: Difference between heat, temperature and sensation towards temperature. The weight and mass.

B: The features, location and function of the equipment and / or systems related human nutrition. The digestive system and digestion in animals omnivores, herbivores and carnivores. Sexual reproduction in animals.

1.2.8. Level 5: (N5 °)

Ch: Chemical elements: metals and non-metals.

Ph: The transfer of heat energy: thermal balance. Energetic balance and power.

B: Artificial sexual reproduction in animals: artificial insemination in cattle and sheep. Energetic and plastic nutrients.

1.2.9. Level 6: (N6 °)

Ch: Density as intensive property of the systems. Corpuscular model of the matter: atom and molecule. The mass conservation law. Lavoisier law.

Ph: The energy and conservation. The thermal energy and temperature.

B: The levels of organization: ecosystem (species), cellular (cell), molecular (DNA). Genetic improvement of plants and animals: the transgenics. Heterotrophic nutrition chains, networks and trophic pyramids. Cycles of matter and energy flows.

2. Logistics project

2.1. Activity 1 (Motivator)

Individual work N3,4,5,1st, 2nd, 3rd, 4th, 5th, 6th.

We shared a snack consisting of milk, cocoa, sugar, cookies and fudge. (They took in their original containers: whole milk, low fat, skimmed milk, and powdered extracalcium milk). Transparent containers were used to place milk.

We used two jars of caramel of different consistency (one creamy and one firm). The teacher asked the students to observe the color, smell, taste and appearance of the milk in the glass and enter their observations in their Science Journal (SJ). He asked the students to observe the color, smell, taste and appearance of

caramel on the cookie and write down in their SJ. Students of N3, 4, 5 who could not read or write, had milk envelopes, bags photos and also photos of a cookie with creamy and firm caramel pasted on their SJ to mark another consistent observation.

Questions as these ones arose: What is milk? What is the cow like? Why is milk white and caramel brown?

2.2. Activity 2

Individual work N3, 4,5,1st, 2nd, 3rd, 4th, 5th, 6th.

We visited to the local supermarket and asked students to write down in their SJ brands and varieties of milk sold, and their due dates. The same was done with caramel and were asked to write down in their SJ whether to tilt or shake the container, if the consistency was perceived "creamy" or "firm". With students N3, 4,5,1^o we worked with photographs and made a game where each child was a product that had to be placed in the refrigerator or on the shelf. We also envisioned milk advertising spot and inquired about the interpretation of his message for the children.

Questions as these arose: Why is the milk bag in the refrigerator and not the one that comes in the box? Why is the caramel on the shelves and not in the refrigerator? What do you mean by "pasteurized and ultra-pasteurized"? What is Omega 3? What does partially "delactosed" mean? Why is the expiration date of the milk box larger than the stock market? Why does caramel last longer? Why is there a "harder" and a "softer" caramel? Among them they were wondering: what kind of milk was used in their homes?

2.3. Activity 3:

Teamwork (4 to work with the milk and 4 with the caramel) N3rd, 4th, 5th, 6th.

We made another visit to the local supermarket and asked students to write down in their SJ, the chemical composition (nutrition), the energy value and the price, in a group of milk and other caramel.

Why this milk is more expensive than this one if they bring the same amount?

At the bakery and deli section we asked the workers what uses they had for milk and caramel. We collected data and the results were recorded in a table that each child kept in his SJ.

From this interpretation of the same new questions arose: Which is the most expensive milk? Why do you think it is more expensive? What chemicals do all milks have in common? What chemicals does caramel have (that milk doesn't)? What chemicals does milk have (that caramel doesn't)? What would be more nutritious: eating caramel or fresh milk? What kind of milk do you think will be most suitable for making the caramel?

2.4. Activity 4

Teamwork experiments with Kit. (*) N3rd, 4th, 5th, 6th

2.4.1. Investigating the presence of water in the milk.

30 drops of milk placed in a test tube. Heat to boiling and placed above a metal spoon. The same is fogged due to condensation of water vapors detached. See also the condensation of water on top of the tube.

2.4.2. Research Carbohydrates present in milk.

To recognize the presence of carbohydrate Fehling Reagent is used. **Use safety glasses.** Place in a test tube 10 drops of Fehling Reagent "A" and 10 drops of Fehling Reagent "B", stirred, heated and adds 20 drops of milk. Reheated. The appearance of a reddish color indicates the presence of carbohydrate.

2.4.3. Investigating the presence of lipids in milk.

In a test tube placed about 20 drops of whole milk, adding a few drops of lemon juice or vinegar to observe that the milk is "cut". Place a small portion of the solid part of curdled milk in a brown paper, leave a few minutes, remove the solid and dry with paper hairdryer.

A translucent stain is when dry, will indicate the presence of fatty materials.

2.4.4. Investigation of the protein in milk.

To verify the presence of protein in the milk, you used in the Biuret Reagent: placed in a test tube 10 drops Biuret Reagent "A" and 10 drops of Biuret reagent "B", add 20 drops of whole milk and gently heated. The appearance of a violet color indicates the presence of protein.

(*) Kit designed for experiments in teams of 4 children, consisting of: 10 test tubes, rack, alcohol burner, plastic lighter, safety glasses, wooden pipe clamp, 6 slide and cover glass, 4

Plastic pipettes, Fehling Reagent (A and B) Biuret Reagent (A and B), kraft paper, thermometer.

We shared of information obtained and the results were recorded in a table that each child kept in his SJ. From the interpretation of the same new questions arose.

2.5. Activity 5

Individual work for class and home. N3rd, 4th, 5th, 6th

They were asked to investigate XO laptops using the Internet:

2.5.1. Location of the geographical areas of Uruguay with higher milk production.

2.5.2. Cattle breeds used in Uruguay to produce milk.

2.5.3. Biography and historical review of Louis Pasteur's investigations.

2.5.4 Historical research on the origin of caramel.

2.5.5. Search for recipes for making caramel.

We shared of the obtained information.

2.6. Activity 6

Visit to a dairy. N3, 4,5,1st, 2nd, 3rd, 4th, 5th, 6th

2.7. Activity 7

Teamwork. Making milk candy (fudge)

N3, 4,5,1st, 2nd, 3rd, 4th, 5th, 6th

2.7.1 Recipe

Heat to high heat in a copper or aluminum pot, stirring until sugar dissolves: 3 liters of milk and 1 kg of sugar. By breaking the boil off the heat add: $\frac{3}{4}$ teaspoon baking soda dissolved in $\frac{1}{4}$ cup of milk. Simmer, stirring with a wooden spoon, periodically and continuously in the beginning to the end. The sweet should thicken and take a tan.

Is about whether to pour a drop on a plate, takes consistency and water hovers on the edge. Remove from heat. Packaged.

Questions as these ones arose: What are the physical states of the ingredients we used to make the candy? Why do you think the pot should be copper or aluminum? What kind of chemicals are these? Place them looking at the periodic table. What is formed by adding sugar to the milk and stirring? Which one the solute and which one the solvent? Is this a homogeneous or heterogeneous system? What happens to sugar as milk is heated by stirring? What are you using on

the spoon to make the milk into the pot to move? How do you explain the fact that at one point of heating process, the "milk goes up"? What temperature thermometer register at the time? How do you explain the formation of the "cream"? What is its physical state?



Figure 1. Milk candy making

If you used a gas stove and to turn it on you used a transparent lighter. What do you see in it? A liquid or gas? When you open its valve what comes out, a liquid or a gas? How do you explain that? How do you call the process responsible for the production of heat in the lighter? Is it a physical or chemical change? What name are its components? If you use an electric stove, how do you explain the production of "heat" on the stove? When you add the sodium bicarbonate (baking soda) to milk who behaves like one as solute and solvent? What do you see when you enter the sodium bicarbonate solution in milk into the pot? Do you think that there is a physical or chemical change? Why do you think that little by little the color in the pot is becoming increasingly brown? What happens to the "density" of the contents of the pot as it gets warmer? Do you think that the mass of the contents of the pot are kept during the manufacturing process of fudge? Why?

N of A: The questions were assigned according to the program content of each level.

2.8. Activity 8

Teamwork experiments with Kit. N3rd, 4th, 5th, 6th

2.8.1. Investigating the presence of water in the milk candy.

Place 1 teaspoon of milk candy in a test tube and push with the spatula to the bottom of the tube.

Heat and place a metal spoon above. Notice that water is not apparent because it was consumed in the manufacturing process of the caramel.

2.8.2. Investigating the presence of carbohydrates in the milk candy.

To recognize the presence of carbohydrate in the milk candy Fehling reagent is used. **Use safety glasses.** Dissolve 1 teaspoon in a glass of milk candy you made up with 20 mL of hot water. Stir well. Place in a test tube 10 drops of Fehling Reagent "A" and 10 drops of Fehling Reagent "B" waves, heat and add 20 drops of liquid with caramel. Reheat. The appearance of a reddish color indicates the presence of carbohydrate.

2.8.3. Investigating the presence of lipids in the milk candy.

Place a small piece of fudge in a brown paper, let it dry for a few minutes and dry the paper with a hairdryer. A translucent stain when dry, will indicate the presence of fatty materials.

2.8.4. Investigating the presence of proteins in the milk candy.

To verify the presence of protein in the milk candy Biuret Reagent is used: place 10 drops Biuret Reagent "A" and 10 drops of Biuret Reagent "B" in a test tube, add 20 drops of liquid with caramel that was used in the recognition of carbohydrates and gently heated. The appearance of a violet color indicates the presence of protein.



Figure 2. Investigating water, carbohydrates, lipids and proteins in the milk candy

2.9. Activity 9

Visit to an industrial plant making fudge.
N3, 4,5,1, 2nd, 3rd, 4th, 5th, 6th

2.10. Activity 10

We shared lunch with the children, their parents and/or grandparents.
N3, 4,5,1st, 2nd, 3rd, 4th, 5th, 6th

2.11. Activity 11

Teamwork. Cleaning
N3, 4,5,1st, 2nd, 3rd, 4th, 5th, 6th

2.11.1. And after cooking: a clean...

There are a number of products that according to what ads say, facilitate cleaning. What do we know about these items, along with their names, maybe prices and uses? How do you make soap? What is the difference between soap and detergent? What does the word "biodegradable" mean?

Children are asked to investigate the history of soap and detergent and its social and economic impact. Some children are suggested to clean with soap and other detergent and then compare the results.

The pilot phase of manufacture of soaps and detergents and the detailed study of their properties constitute a goal to develop in the next project. However, as a support to the teacher regarding the information that children can be raised in the class, we provide the following information.

2.11.2. Cleaning action of soaps and detergents

Cleaning any object is to remove substances undesirable acceded to it. Dirt, is usually a heterogeneous mixture of substances of various origins and characteristics.

Technically we call **detergents** to all agents that serve washing, but in practice we call synthetic detergents, or just detergents, to the ones that are obtained from petroleum derivatives, and **soaps** which are obtained from tallow or animal oils or fats vegetables.

The difference between soaps and detergents does not only rely on the use of raw materials to obtain them, but also in their chemical composition, and therefore, in some of its properties.

As the first detergent obtained were liquid, many people often identified as soaps as solids and detergents as liquids, but this concept is incorrect.

The washing process involves two stages: the removal of dirt from the surface by washing and

distribution in the washing liquid, without re-depositing.

In the case of fabrics it is essential, first, to achieve good wetting. To remove dirt, cleaning solution must penetrate between the fibers, i.e., between the interstices of the dirty fabric. The agitation (either by hand scrubbing action or movement in the case of a washing machine) and the use of hot water, favor the detachment of the fat (generally adhered powder) which is suspended in the soapy water, forming small globules. This situation is stable and prevents dirt redeposit on the washing object.

Thus dirt cloths and scrubbers were washed during the manufacture of caramel.

Both detergents and soaps are constituted mainly by substances exhibiting, in its structure, an extreme water-soluble (**hydrophilic**) and the rest therein insoluble (**hydrophobic**). In industry, these substances are called **surfactants**. If the surfactant is attacked by microorganisms in the environment, it is said that the detergent is biodegradable.

3. Results

The implementation of the project resulted in:

- 1) Prioritize the ongoing interaction between science and society.
- 2) Encourage respect for the environment.
- 3) Develop hypothetical-deductive thinking, and inductive reasoning by analogy.
- 4) Interact with reality.
- 5) Participate actively in society.

Through a common thread: milk and its use to make the delicious caramel that all Uruguayan children adore:

- 1) It was possible to work on curriculum issues of science that were from the aggregation states of solid and liquid matter and its organoleptic properties (levels 3 and 4) to the density and intensive property and the principle of conservation of mass (6th year).
- 2) Inter-multi-transdisciplinarity of Natural Science was achieved.

4. Conclusions

Eventhough working dynamic was new to most of the participating children and they found it difficult to adapt, they quickly overcame these difficulties with increasing interest and research

consulting, leading in turn to greater scientific and technological curiosity and a critical development. Perhaps the greatest difficulty encountered was that all children were active at the same time during the development the experiments and to cook the caramel.

We achieved a good articulation between inquiry, research, experimentation and development of oral and written expression.

The research on the "history of milk candy" allowed them to relate the historical situation of Uruguay with the nineteenth century America and understand why so many American countries "compete" now in the fact of being the "inventors" of caramel.

A visit to the local supermarket allowed the children to perceive that the object of study was related to everyday life situations and that it would be useful to understand situations related to food products that their family regularly buy.

The visit to the dairy allowed to contact the rural social environment and learn about nutrition, digestion and reproduction of cows, assisting the state of pregnancy and the process of artificial insemination.

It also allowed them to develop respect for the environment and the use of alternative energy sources to learn the operation of a device that uses cow manure to generate methane gas.

The visit to the industrial manufacturing caramel plant gave children the opportunity to observe the operation of machines, ensuring that the same process that they performed in a "hands on" way was small-scale while large-scale was done using machinery and different energy sources, then making the connection between science and technology.

Sharing snack with parents and/or grandparents managed to involve the family in the project and show the knowledge and skills acquired by children in the process.

Scientific language used in different activities throughout the project was adequate prior knowledge acquired by children according to their different school level and the demands of the curriculum required by the educational authorities of Uruguay. With children of N3, 4,5 not yet literate, we worked with images, pictures and drawings that they ordered, classified and grouped according to requirements.

The impact of activities on children who participated in the project was to achieve a high motivation in the study of science in general, an increase in the ability to manipulate materials and equipment necessary for carrying out the

experiments as well as a predisposition to analyze and question the situations generated beyond the scientific frontiers.

5. References

- [1] Córdova Frunz JL. The chemistry and cooking; México, FCE; 2002
- [2] Barham P. The Science of cooking. Berlin. Germany. Springer-Verlag; 2001
- [3] Cobb V. Science experiments you can eat. New York. Harper Trophy; 1979
- [4] D Amico J, Drummond KE J. The Science Chef. Wiley & Sons; 1995.
- [5] Gardiner A, Wilson S. The inquisitive cook N. York. U.S.A. Explor. / Henry Holt; 1998.
- [6] Gardner R. Kitchen Chemistry. New York. U.S.A. Julian Messner; 1981.
- [7] Hillman H. Kitchen Science. Boston. U.S.A. Houghton Mifflin Co; 1989.
- [8] Golombek D, Schwarzbaum P. The scientific chef. BBAA. Argentina. Siglo XXI; 2005.
- [9] Di Genova F. The bartender scientist. Buenos Aires. Argentina. Siglo XXI; 2008.
- [10] Blok R, Bulwik M. At breakfast there chemistry. Buenos Aires. Argentina. Ed. Magisterio del Río de la Plata. 2009.
- [11] Koppmann M. Manual of molecular gastronomy. BBAA. Arg. Siglo XXI; 2009.
- [12] Inquiry and the National Science Education Standards: A Guide for Teaching and Learning Editorial of the National Academy of Sciences of the United States; 2000.
- [13] Pozo, Monereo. The strategic use of knowledge. Castelló. España. Editorial Alianza; 2001.
- [14] Transforming American Education: Learning Powered by Technology. National Science Foundation. U.S.A.; 2010.
- [15] Ensino de Ciências por Investigação. Univ. de São Paulo. Brasil; 2009.
- [16] Explorações em Ciências na educação infantil. Univ. de São Paulo. Brasil.; 2010.
- [17] Charpak G. L'Enfant et la Science: La main à la pâte. Paris. France; 2005.
- [18] Harlen H. Primary Science: Taking the Plunge. U.S.A. Heinemann. 2001.
- [19] Charpak G. Enseigner les sciences et à l'école maternelle élémentaire: Guide to découverte La main à la pâte. Paris. France; 2000.

HOW ATMOSPHERIC PRESSURE CAN LIFT AN ADULT- HANDS-ON EXPERIMENTS BY USING SYRINGE-SYSTEM

¹C. H. Chou, ²M. S. Yang

National Kaohsiung Normal University,
Taiwan

¹ t1620@nknuc.nknu.edu.tw

² maysun5433@gmail.com

Abstract. *The purpose of this paper is to explore the possibility to develop students' concept and understanding of atmospheric pressure with hands-on physics experiments. Three hands-on kits used for different goals, in which medical syringes and industrial syringes as the main components were used. The first one is a convenient one for quantitative analysis by students themselves on atmospheric pressure. The second one is made up of industrial syringes and for the demonstration of heavy handling by atmospheric pressure. The last one, syringes form a lifting control system and act as vacuum tubes that can lift up an adult. The results show that the participants were impressed by the demonstrations that it helped them to understand the concept of atmospheric pressure and how the concepts come from.*

Keywords. atmospheric pressure, hands-on, syringe, demonstration

1. Introduction

In current education, science teachers need to establish methods of lively teaching activities, inquiry through experiments, learning from daily life and also to put lots of efforts to bring up students' abilities, such as, initiative to identify problems, scientific inquiry and problem solving. Hands-on activities that can stimulate students' interest, and cultivate scientific attitude and scientific method, are emphasized in science learning. Through the experimental activities students could learn how to inquiry about the nature of science, science attitude and science process skills. Experimental activities have been part of science education for a long time. The application of proper experimental activities can



help students to construct knowledge [1, 2, 3, 4]. Elements in the plastic syringes kits that are commonly used in medicine, industry and aquarium can be used in scientific experiments activity design. The syringe can easily provide a varying closed space with its movable piston. They can be applied to many concepts to explore, including the principle of the connecting pipe, Pascal's principle, Boyle's law, buoyancy, etc. They can also be used in conjunction with hoses, valves and stopcocks to simulate daily life goods such as balloon inflator, hydraulic control mechanical system, etc. Plastic syringe experiment kits are low cost, easy to obtain, durable in normal use and convenient for creative combination just like the common Lego block. Students can learn science and develop creativity by applying these simple things in science experiments.

2. Methodology

In order to develop atmospheric experimental devices by using plastic syringes and to study the effectiveness of their teaching, first we formed a professional team to design teaching aids. Then we constructed materials, teaching plans and learning sheets following the science teaching mod, Hot-IHVs (Hands-on-Toward Interactive Historical Vignettes) [5,6,7,8]. These teaching materials have been under five science education experts review. Finally, the qualitative data of effectiveness of learning and students' feelings were collected after a 2-hour lesson. One set of data came from 34 non-science major students at a university and the other from 35 grade nine junior high school students. The comments about those innovative devices and science teaching models were also collected from 35 primary or secondary school science teachers after a 3 hours workshop.

3. Results and Discussions:

(1). Atmospheric Pressure Experimental apparatus

There are three innovative devices made in accordance with different teaching functions and operational ways; the hands-on type, the hanging type and the lifting type. All three atmospheric pressure experimental apparatuses are described below.

The hands-on type

A closed cavity is made by a plastic syringe and a three-way stopcock. It is very easy to change, open or close. A plastic bag is tied on the syringe with a rope as a scale, and the filled water bottles as weights (fig. 1a).

It can be used as typical hands-on experiments done by students themselves even in an ordinary classroom. It can also be used for demonstration operated by teachers. In this case, students will observe and record the data together (fig. 1b). The operation method is very simple. First, open three-way stopcock, push the syringe plunger to the bottom. Second, close the three-way stopcock. Finally put the water bottles into the bag one by one until the piston starts to move.

The magnitude of the atmospheric pressure is about 1 kilogram per square centimeter. The hanging force can be estimated once the cross-sectional area of the piston to be known. There are two simple methods to calculate this area. Measure the actual distance between two scales on the ruler on the syringe, then take the scale of the displayed volume divided by the distance. Otherwise, measure the internal diameter of the syringe directly, and then calculate the area. The cross-sectional area of different kind syringes with the same capacity will be different. To "Top" label 20cc syringes, for example, the actual distance between the scales of 20cm³ capacity is 6.30cm, so the available cross-sectional area is 3.17cm². Multiple it by the atmospheric pressure 1033.6 gw/cm², in general conditions. The hanging weight will be 3277gw. Friction between the plunger and cavity is more than ten percent of the hanging weight. The actual hanging weight would be about 5 to 600c.c. bottles of water.

The hanging type

To lift a real person is possible which will indeed to deeply impress students about the concept of atmosphere. Instead of the medical syringes which are with a small cross-section, a larger 300c.c. industrial syringe, (fig. 2a) is used in this apparatus. The cross-section is approximately 20cm², and the hanging weight could be 20 kg or more. With two syringes, it can hang a weight of nearly 40 kg, as shown in fig, 2b.

The lifting type

Although we can increase the hanging weight by

using multiple syringes, there are always some technical flaws in it, mainly caused by the leaning plungers. The special design device in fig. 3 is made of acrylic and metal materials with 130cm² cross-sectional that could be used to suspend a 60-kg adult. It can also be used to lift weight with an air-pumping system consisting of syringes and shutter (fig, 2a). Even though the friction would reduce the lifting weight it can still lift an adult easily.



Figure 1a. The hands-on type



Figure 1b. Demonstration



Figure 2a. The hanging type with an air pump



Figure 2b. Hanging a nearly 40kg weight

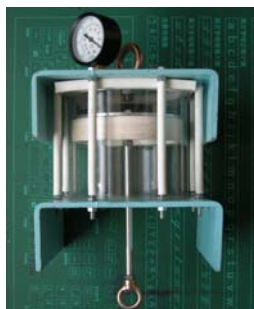

Figure. 3. The lifting type, to suspend a student

Teaching empirical results

The data from the effectiveness of learning and students' feelings was collected from the non-science major students in a university and nine

grade junior high school students and analyzed qualitatively. The comments about those innovative devices and Hot-IHVs science teaching mode were also collected from primary or secondary school science teachers after a 3 hour workshop.

The effectiveness of learning

Students expressed that they could learn and comprehend the following with Hot-IHVs:

- Galileo's "vacuum force" is equal to the atmospheric pressure multiplied by the area.
- There are multi-ways to understand the atmospheric pressure and Galileo's "vacuum force" assertion.
- Atmospheric pressure can be measured by using water bottles and syringes.
- How Galileo's "vacuum force" assertion formed.
- Suspending a person in mid-air by using a simple type apparatus.
- How to design experiments, as well as how results are summarized.
- Experiment operation skills
- Experiments will give people a deep impression on knowledge.
- It is easy to understand experiments and theory combined together.
- To understand why we do not feel the atmosphere usually due to the balance between outside and inside pressure.
- Easy to remember for the real life related material
- More interest in the natural sciences
- What a scientist's life it is.
- The scientist's attitude to explore with courage like Galileo's fearless conflict with the church.
- The interesting dialogues of Galileo
- Scientific methods.
- Development of science.
- That old knowledge often has skepticism.
- Truth to be proved by scientific evidence.
- There are always lots of efforts for making scientific discoveries.
- How to think, to prove and to overthrow.
- Scientific discoveries do not come suddenly, but need effort and accumulation of knowledge.
- Making hypotheses, designing

experiments, and having the right attitude.

- New knowledge with an open mind

Students' feelings

Students' responses to Hot-IHVs teaching:

- There is a great power and influence for the atmospheric pressure which is usually invisible and ignored.
- There is an unbelievable huge force in the atmosphere
- Intuitively feeling the atmospheric pressure
- The atmosphere is like a magician, so wonderful
- Scientists to persist in science by their believe
- Dissolve to that scientists dedicate to the truth of science in the information lack age.
- To pay tribute to who dedicate to the hands-on experiments development.
- Learning motivation to be excited by those simple hands-on experiments.
- Daily goods can be an element of the experiment apparatus.
- Concepts or apparatus of the atmospheric pressure can be used in life, such as machines and extremely heavy hanging.
- Science is always found everywhere in daily life.
- Physics is fun, for it can be applied in daily life.

Comments of school science teachers

More than 90% sample teachers highly approved of Hot-IHVs teaching with the atmospheric pressure apparatus. Agreement to all questions is average up to more than 4.70 and it's between "agree" and "strongly agree" on a five-point Likert scale and it is also significantly higher than the theoretical midpoint ($p < .05$). Those data means that the subject teachers agreed very much with those innovative hands-on aids and creative teaching mode about the atmospheric pressure. They will use it in their future teaching and expect to participate again in similar workshops. They agree with the safety of the equipment, and that it can contribute to teaching and can stimulate students' curiosity, these concepts and equipment are easily found in life,

and it is a beautiful combination between hands-on and scientist stories.

4. Conclusions and Suggestions

With some elements and accessories from three different fields, medicine, aquarium, and industry, we can make useful scientific teaching aids by using plastic syringes. Three innovative devices were made, thus the hands-on type, the hanging type and the lifting type in accordance with different teaching functions and operation ways, for atmospheric pressure concept teaching. These devices are easy to make, easy to operate, and can enhance the effectiveness of teaching, in areas such as scientific knowledge, experimental skills, scientific inquiry, scientific interest, scientific attitude and the nature of science. Most participants expressed surprise at the power of atmospheric pressure lifts, the simplicity of the equipment, easy to link with life, interest to physics, as well as the understanding of some of the attributes of the scientists.

Participating students and teachers' feedback reflects a positive recognition of these devices and with the teaching of the history of science, they could be widely applied. There is some room for improvement and refinement of these teaching aids and teaching mode.

5. References

- [1] Hadzigeorgiou YA. "Study of the Development of the Concept of Mechanical Stability in Preschool Children.", *Research in Science Education*, 32(3), 373-91. 2002.
- [2] King KP. "Inertial mass", *Science Scope*, 31 (4). 2007.
- [3] Tamir P. "Factors Associated with the Relationship between Formal, Informal and Non-formal Science Learning", *Journal of Environment Education*, 22(2), 34-42. 1990.
- [4] Tobin KG. "Research on Science Laboratory Activities, In Pursuit of Better Questions and Answers to Improve Learning.", *School Science and Mathematics*, 90, 403-418. 1990.
- [5] Conant JB. "Harvard Case Histories in Experimental Science." Harvard University Press", Cambridge, MA.; *Journal of Research in Science Teaching*, 24(2), 145-160. 1964.
- [6] Kuhn TS. "The Structure of Scientific Revolutions", Chicago: University of

Chicago Press. 1962.

- [7] Matthews MR. "Science Teaching- The Role of History and Philosophic of Science". New York. 1994.
- [8] Wandersee IH, "More history and philosophy of science in science teaching:" Proceedings of the first international conference 277-283, Tallahassee, FL: Florida State University. 1990.



INVESTIGATING PROPERTIES OF LIGHT IN THE FRAME OF LOWER AND UPPER SECONDARY EDUCATION

**Martin Hruška, Stanislav Holec,
Jana Raganová**

*Faculty of Natural Sciences, Matej Bel
University Banská Bystrica,
Slovakia*

*martin.hruska@umb.sk,
stanislav.holec@umb.sk,
janka.raganova@umb.sk*

Abstract. *A few inquiry based experimental activities belonging to the topics Light (ISCED 2) and Electromagnetic radiation and the particles of microworld (ISCED 3) are discussed in this paper. Some of them are realised with the use of a school spectrometer or sensors and computer support.*

The introduced experimental activities are focused on the properties of light sources – light spectra and ultraviolet and infrared radiation produced by various light sources. Properties of the reflected and transmitted light and the relation between the colour of objects and incident light characteristics are also explored.

Most of the presented experimental activities are suitable for the pupil exploring in the learning process due to their simple implementation and possibility to interpret the measured data immediately.

Methodological remarks and proposals for the use in teaching are included in each activity and the connection between explored effects and real life situations is emphasized too.

Keywords. Experiments, electromagnetic radiation, light, spectrum, spectrometer.

1. Introduction

In recent years, modern inquiry based approaches have become a fundamental part not only of physics education but science education in general as well [1].

An increased need for a more rigorous application of the new approaches in science education in the Slovak Republic [2, 3, 4, 5], closely relates to findings of international PISA testing 15-year old students' science literacy taken in 2006 and 2009, in which Slovakia participated, too. According to the PISA 2006 and 2009 national reports [6, 7], science literacy of Slovak 15-year old pupils is significantly lower in statistics than the average of OECD countries.

It is beyond doubt that a school experiment has a great impact on a cognitive and creative educational process (especially in science education) and it acts as a motivator arousing pupils' interest in physics and science in general. Thus one of the ways how making science teaching at Slovak secondary and high schools more effective is to reinforce the experimental character of science by means of standard as well as computer aided experiments.

Not a less important factor is a more rigorous utilization of content inter-subject links that enables to systematize knowledge more qualitatively and to develop the abilities of knowledge synthesis and transfer from one subject to another one. Moreover using everyday pupils' experience this approach enables to explain basic science topics with a facile and attractive form.

These are the preconditions which gave the foundations to the group of researchers at the Department of Physics, Faculty of Natural Sciences, Matej Bel University Banská Bystrica for designing the content and methodology of conducting the experimental activities, which form a part of a developed digital teaching material [8].

The following sections contain examples of selected experimental activities belonging to the topics *Light* (ISCED 2) and *Electromagnetic radiation and the particles of microworld* (ISCED 3), which are currently being prepared in the frame of project KEGA "The use of new methods and forms in training of physics teachers and their pupils with emphases on the development of their competencies in science inquiry" at the department of the authors. Presented activities designed on a general level

are realised with the use of school spectrometer Spectra-1 (Fig. 1). The spectrometer measures the spectrum of light in the spectral range between 360 nm and 940 nm with the pixel resolution less than 0.5 nm. The optical signal enters the device through the open area or the flexible optic fibre. Data's side is connected to the computer with USB 2.0 interface and software for data collection produces real time graphics output. Intensity of light plotted on the y-axis of the measured spectrum is expressed by the relative arbitrary unit.

For easier interpretation of the spectrum, every wave band is marked with corresponding colour. The spectrum can be exported in a graphic form for easy publication, or in a text form for more advanced calculations.

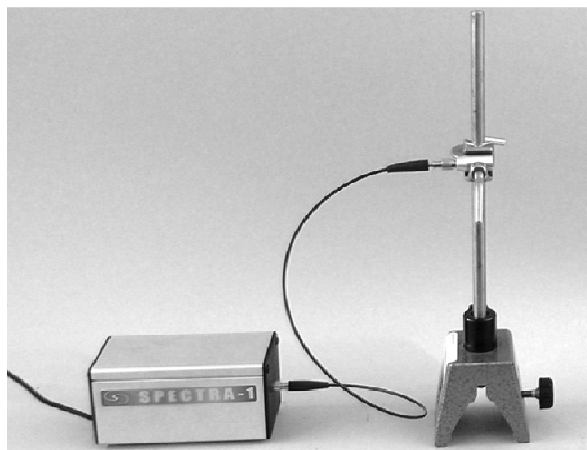

Figure 1. School spectrometer Spectra-1

2. Why is the sky blue?

The aim of the experiment

The experiment is focused on comparison of the lunchtime and evening (or morning) sun spectra. It points to the existence of molecular scattering of light and the possibility of its implementation in the laboratory conditions.

Procedure

Measure the spectrum of the sunlight at lunchtime and in the evening with the help of school spectrometer Spectra-1. Compare the measured sunlight spectra and observe the differences. Measure the blue light of the sky. Prepare a transparent aqueous solution of milk. Observe the colour of light passing through the solution, measure its spectrum.

Measured data

As seen in Fig 2, evening sun is more yellow or

orange like lunch sun. Besides blue the spectrum of the blue sky still contains other colours, as green and yellow.

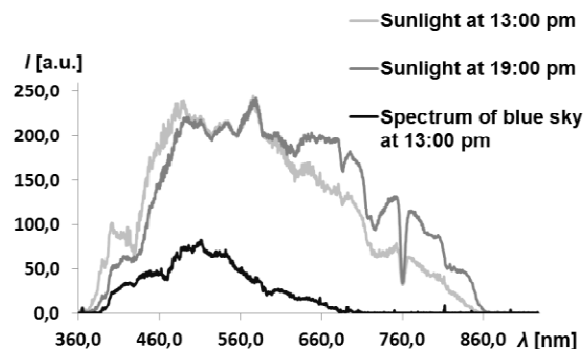

Figure 2. The evening and lunch sunlight spectrum and spectrum of the blue sky

Fig. 3 shows the spectrum of light passing through the milk solution. It is more red than the original spectrum of the halogen bulb.

Science around

As the sun approaches the horizon, its colour changes from dazzling white to bright yellow, orange and even to deep red.

Sunlight consists of light of every wavelength and is very close to perfect white. It reaches the earth and begins filtering through the atmosphere. According to Lord Rayleigh's theory of molecular scattering the intensity of light scattered by a single small particle from a beam of unpolarized light is inversely proportional to the fourth power of the wavelength. The shorter the wavelength (or 'bluer') the light is, the greater its chances are of being scattered. This means that when we look in any part of the sky except directly toward the sun, we are more likely to see a blue scattered light. Even the bluest sky still contains all colours of the spectrum. Solar disc is more orange or red in the morning or in the evening because the shorter wavelengths of 'bluer' light is more scattered than longer wavelengths of 'redder' light.

But there is another factor that is needed to explain red suns: particles. These are primarily dust and smoke, though over the ocean water droplets are also present. Particles smaller than about 100 nm in diameter are particularly efficient scatterers and their influence is far greater than that of air molecules (like particles of milk in the milk solution). Their presence in the atmosphere further reddens the sun. Because the number of particles is variable from day to

day, successive sunsets are equally variable [9].

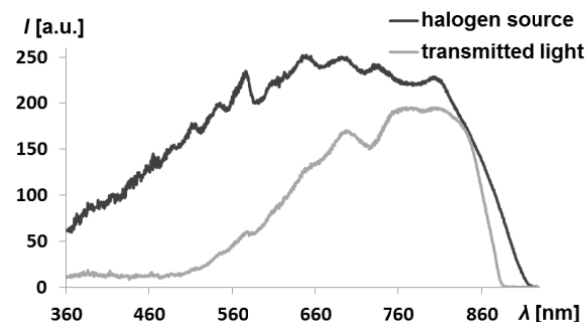

Figure 3. The spectrum of the halogen lamp and spectrum transmitted through the aqueous solution of milk

4. Spectrum of chlorophyll

The aim of the experiment

An observation of the chlorophyll spectrum using self-made-spectroscope is one of the experimental activities proposed in the physics textbook [10]. In the following experiment we measure the spectrum of chlorophyll using a school spectrometer and compare it with the light reflected from grassland.

Procedure

Prepare a solution of chlorophyll from the leaves of nettle. Determine subsequently the chlorophyll spectrum with the help of a school spectrometer using either sunlight or a stronger bulb providing a continuous spectrum. Compare the spectrum of chlorophyll to the spectrum of the reflected light of the grass during a bright sunny day (simply point a flexible optic fibre to the sunny lawn).

Measured data

As seen in Fig 4, the absorption spectrum of the chlorophyll is similar to the spectrum reflected from the grass.

Chlorophyll strongly absorbs in the ultraviolet area and in the red part of the spectrum but only orange-red part of the spectrum is suitable for the photosynthesis.

Therefore the light passing through a solution of chlorophyll as well as the light reflected from the parts of plants containing chlorophyll is green. The spectrometer can display the spectrum in the near-infrared region, so we can see that these wavelengths are not absorbed by chlorophyll. Near-infrared radiation freely passes through leaves and plants or it is reflected.

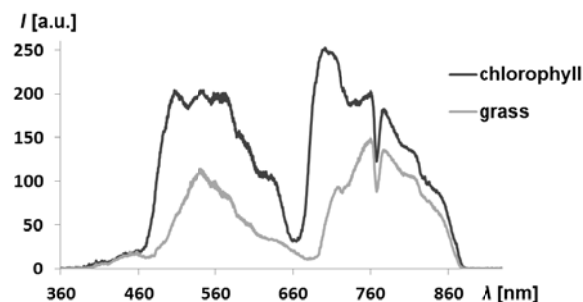

Figure 4. The absorption spectrum of the chlorophyll and the reflected spectrum of the grass

Science around

Chlorophyll is a green pigment found in cyanobacteria and the chloroplasts of algae and plants. It is an extremely important biomolecule, critical in photosynthesis, which allows plants to absorb energy from light. Chlorophyll absorbs light most strongly in the blue portion of the electromagnetic spectrum, followed by the red portion. However, it is a poor absorber of green and near-green portions of the spectrum, hence the green colour of chlorophyll-containing tissues.

The function of the vast majority of chlorophyll is to absorb light and transfer that light energy to the other chlorophyll pigments. Plants make their food from carbon dioxide from the air and water from the soil. These are combined to form carbohydrates like sugar and starch [11].

5. Reflected and transmitted light

The aim of the experiment

When light bounces off a surface at the same angle at which it strikes the surface, we say that light is reflected and call this phenomenon reflection. Transparent materials allow the light to pass through them so that you can easily see what is on the other side.

Use the school spectrometer to study properties of the reflected or transmitted light.

Procedure

Measure the spectrum of light reflected from different objects with the school spectrometer. The measurement is best implemented as a pupil activity on a sunny day outside in nature. It is possible to measure the reflected spectrum of grass, flowers, or clothes, car paint, walls of houses and other surfaces subsequently. Similarly, we can examine the spectrum of light passing through the different objects – glass vases or glasses, transparent foils and colour filters.

Measured data

As seen in Fig 5, green foil transmits wavelengths mostly in the green region of the spectrum and partly in the red and infrared. Similarly the red tulip flower spectrum (Fig 6) consists of a relatively wide range wavelength from yellow-orange to red colour. The flower tulip also reflects and transmits wavelengths corresponding to near-infrared area. The transmitted and reflected spectra of the tulip flower are very similar.

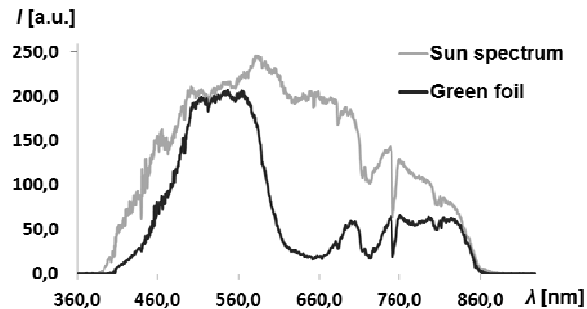

Figure 5. The transmitted spectrum of the green foil compared with the sun spectrum

Science around

Sunlight can be reflected from objects. Albedo is the percent of radiation returning from a given surface compared to the amount of radiation initially striking that surface and represents the reflectivity of the surface. Typical albedo of various surfaces is shown in Table 1.

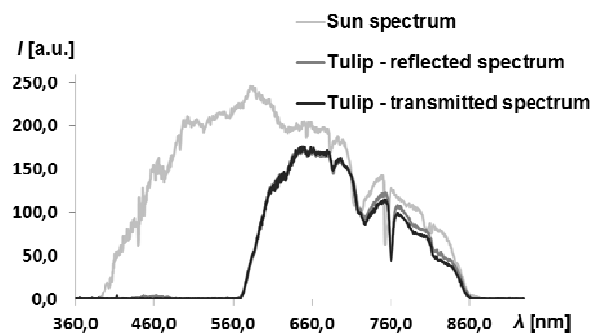

Figure 6. The transmitted and reflected spectrum of the tulip flower compared with the sun spectrum

Light that passes through a substance is said to be transmitted. Upon entering an optically denser substance, the transmitted light slows in speed. If it enters the substance at an angle, the light's path also bends. This bending is called refraction. Refraction (bending) of light by the atmosphere causes stars near the horizon to appear higher than they really are. It also causes

the sun and the moon to rise earlier and set later than they otherwise would [12].

SURFACE	ALBEDO (%)
Fresh snow	75 to 90
Ice	30 to 40
Sand	15 to 45
Water	10
Forest	3 to 10
Earth and atmosphere	30
Moon	7

Table 1. Typical albedo of various surfaces [12]

6. Conclusion

An intention of the introduced experimental activities is to contribute to a broader use of investigative methods in physics education and to the development of students' competencies in the field of science investigations.

The activities will be incorporated into a digital teaching material that will be dedicated to in-service training of practicing physics teachers as a part of their lifelong education. The material will be implemented into the future physics teacher training programme as well. The teaching material will focus on the utilization of new investigative methods in education with emphases on development of key student's competencies in the area of science investigations.

The material will contain the textbooks covering selected areas in physics; suggestions of practical investigative activities in the form of student worksheets and methodological guides for teachers; the database with videos of experiments and the measured experimental data available for further processing.

The developed texts and guides will be freely available for download on the website. Printed version of the above materials will be also available.

Besides the teaching materials an in-service course for teachers will be prepared, that will stress upon an application of new methods and forms in the teaching/learning process.

The created material will be used during this course and will be supplemented with a methodological guide for the teacher so as an effective use of the created teaching materials in the classroom could happen.

The teaching material can be further utilized in teaching process directly, both at upper and lower secondary levels.

7. Acknowledgements

The support received under project KEGA 022UMB-4/2012 " The use of new methods and forms in training of physics teachers and their pupils with emphases on the development of their competencies in science inquiry" is gratefully acknowledged.

8. References

- [1] Rocard M et al. Science Education Now: A Renewed Pedagogy for the Future of Europe; 2007. http://ec.europa.eu/research/science-society/document_library/pdf_06/report-rocard-on-science-education_en.pdf. [visited 21-June-2012]
- [2] Ješková Z, Kireš M, Onderová Ľ. Školská reforma na Slovensku mení spôsob výučby prírodných vied. Čes. čas. fyz. 2012; 62(5-6): 316-319.
- [3] Zelenický Ľ et al. Empirické poznávanie v prírodovednom vzdelávaní. Nitra: UKF; 2011.
- [4] Lapitková V. Fyzikálne vzdelávanie v systéme reformovaného vyučovania. Studia Scientifica Facultatis Paedagogicae 2012; 11(5A): 9-19.
- [5] Krišťák Ľ, Spodniaková Pfefferová M. Computer based experiments in oscillation and in nuclear physics at secondary school. In: Information and Communication Technology in Education 2006. Ostrava: University of Ostrava; 2006, p. 115-119.
- [6] Národná správa OECD PISA SK 2006. http://www.nucem.sk/documents//27/medzinarodne_merania/pisa/publikacie_a_diseminacia/1_narodne_spravy/Narodna_sprava_PISA_2006.pdf [visited 15-May-2013]
- [7] Národná správa OECD PISA SK 2009. http://www.nucem.sk/documents/27/medzinarodne_merania/pisa/publikacie_a_diseminacia/1_narodne_spravy/Narodna_sprava_PISA_2009.pdf [visited 15-May-2013]
- [8] Spodniaková Pfefferová M. Fyzika okolo nás - online databáza simulácií. In: Tvorivý učiteľ fyziky IV. Košice: Equilibria; 2011, p. 213-219.
- [9] Lynch KD, Livingston W. Color and Light in Nature. Cambridge: Cambridge University Press; 1995.
- [10] Lapitková V, Koubek V, Morková Ľ. Fyzika pre 8. ročník základnej školy a 3.

ročník gymnázia sosemročným štúdiom. Martin: Vydavateľstvo Matice slovenskej; 2012.

- [11] Bethell G, Coppock D. Integrated Science 1. Oxford: Oxford University Press; 1995.
- [12] Ahrens DC. Meteorology Today. Ninth Edition. Belmont: Brooks/Cole; 2009.



SCHOOL PHYSICS EXPERIMENTS FROM THE FIELD OF NUCLEAR PHYSICS

Peter Zilavy

*Charles University in Prague, Faculty of
Mathematics and Physics, Czech Republic
Peter.Zilavy@mff.cuni.cz*

Abstract. *As in other areas of physics, the real experiment plays an important role also in teaching of nuclear physics. Nowadays various safe sources of ionizing radiation and the corresponding detectors are available and allow us to make simple and conclusive experiments in the field of nuclear physics at all types of schools.*

The paper discusses the influence of back-ground radiation on the interpretation of results from school measurements with weak radiation sources.

The paper also shows several examples of experiments demonstrating the fundamental phenomena of nuclear physics such as the existence of radiation from natural or artificial sources (including objects around us), shielding of the radiation using different materials, some properties of gamma radiation, basic ways to protect against radiation and other.

Keywords. Background radiation, radiation detection, school physics experiments, school radiation sources.

1. Introduction

Similarly to other fields of physics, the real experiment plays an important role also in teaching of nuclear physics. For more than 15 years, Czech schools have used the set Gamabeta, or its newer version GAMAbeta

2007, to demonstrate directly the elementary phenomena of nuclear physics (e. g. the existence of radiation, its shielding by various materials, some properties of beta and gamma radiation, the basic methods of radiation protection etc.). Safe sources of gamma or beta radiation, Geiger-Müller (GM) detector and (computer controlled) counter are the key parts of these sets. [1], [2]



Figure 1. School gamma radiation source SZZ Gama 30 kBq

The source of gamma radiation in these sets (Fig. 1) is equipped with emitter containing radionuclide ^{241}Am . Half-life of this radionuclide is about 432 years (it means that the activity of the emitter would drop approximately by 6% during 40 years of teacher's career). The emitter itself produces the gamma radiation with the energy of 60 keV and the alpha radiation with the energy of 5.44 MeV and 5.49 MeV. This radiation is accompanied by a soft X-ray radiation (coming from the electron shell of atoms). The output of the alpha radiation from the source is inhibited. The emitter activity is about 30 kBq, which means there are about transformations per second.

The use and distribution of radiation sources in the Czech Republic is controlled by the Czech Act No. 18/1997 Coll. – so called Atomic Act [3]. According to §21 of this Act, in case of the *source of low significance* (as the source from Gamabeta set is) or in case of so called *minor radiation source of approved type* (where does the new, more powerful and furthermore described Demonstrative radiation source DZZ Gama 300 kBq belong), there is no need for any approval to use these sources in the Czech Republic. Before the *minor radiation source of approved type* is being used for the first time, the user is obliged to announce the regional State office of Nuclear Safety of the use. Usually, this

is done by the distributor of the source.

2. Sensitivity of the school GM detector

Experience says that the school GM detector from the Gamabeta set is capable to recognize small units of particles within a second in case the detector distance is several centimetres from the radiation source. How does it comply with the above mentioned information about the number of transformations in the source?

Let's take the source in a simplified view (and to do at least a raw estimate) as a dot source emitting the radiation in all directions of the space equally. Assuming the common setup in which the radiation source and the detector (with Geiger-Müller tube of 9 mm diameter and "active" length of about 70 mm) are located close to each other, the distance of the tube centre from the radiation source is 40 mm. Using the respective angles and simple integration of spherical coordinates we can show that the detector tube "covers" only about 2.5 % of the spatial angle around the radiation source. The GM tube of the detector is therefore subject to only this low percentage of all particles emitted by the source.



Figure 2. Emitter of SZZ Gamma 30 kBq

In fact, the radiation source represents more planar source (Fig. 2) than the dot source, emitting the radiation more forward than sidewise from the emitter axis. Dependence of the number of particles on the angle from emitter axis can be approximated by the cosine or parabolic function (see example of measurement on Fig. 7). At correct aiming of the source and the detector, the particles get to the detector (at the same settings of the experiment) at a bit bigger volume than is stated in the previous

paragraph. Nevertheless, we can expect only small percentage of all particles from the source to get to the detector.

Other important fact that must be taken into account is the low efficiency of the GM tube in gamma radiation detection. The efficiency depends on the energy of gamma radiation. The [4] states the efficiency lower than 1%. More about the radiation detection (not only using the GM tube) can be found e.g. in [4].

During regular use of GM detector and the radiation source from the Gamabeta set, we can, due to the physical principles, detect only about 1/10 000 of particles emitted from the radiation source. For radiation source activity of 30 kBq we therefore recognize the particles only in quantity of units per second.

3. “Tricky” background correction

Natural radioactivity varies according to location, where measuring is performed. It is affected by terrestrial radiation (released by rocks and soil in the area) or cosmic radiation. The overall radioactivity at the background may be reinforced significantly by radioactivity of the construction material of the buildings.

In teaching conditions, the Gamabeta set detector can usually detect about 25 to 70 pulses per 100 s in average (depending on the site) due to background radiation.

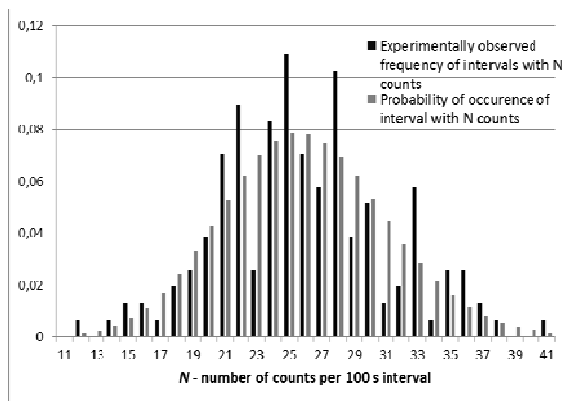

Figure 3. Poisson distribution

As the processes in micro world – resulting in natural radioactivity – are of probability pattern, the number of pulses registered by detector per fixed time unit is as well a random quantity. It can be described by so called Poisson distribution (further explanation and reasoning e.g. in [4]).

Poisson distribution is determined by only one

parameter, which is mean value of the number of pulses per fixed time unit. Light columns in Fig. 3 show what is the probability based on this distribution for mean value 26 pulses at 100 s (you can compare this theoretical probability with experimentally obtained values, represented by dark columns).

In the Fig. 3 can be seen, as well, that exact 26 pulses per 100 s can be measured with probability of only 7.8 % and with almost 30 % of probability the measured number of pulses per 100 s would be outside the 20-30 pulses interval. Experimentally obtained frequencies in 156 measurements of the length of 100 s with mean value as stated with the above theoretical computation are described as dark columns in the Fig. 3. Such a measurement can be easily performed at schools e. g. automatically overnight, using the GAMAbeta 2007 set – the counter should be interconnected to a PC, the control software should be set to counting period 100 s and Repeat option should be activated. The results are stored into a file that can be processed e. g. in Excel. The Remote School Laboratory for Radioactivity Examination “on the internet” can be used as well [5].

We can assume that the background value, stated as an individual measurement or as an average of several measurements can *significantly differ* from the real value. Similarly the number of pulses in different measurements in respective time intervals can differ among each other. Therefore if we work with low number of detected particles (e. g. when measuring the dependence of number of detected particles on the distance from the radiation source or on the thickness of shielding material), the variance of measured background values is of high importance when interpreting the measurement results.

Similarly as in case of the background the number of particles released from the radiation source and registered by the detector in the time of 100 s is a random quantity that can be described by Poisson distribution. In the presence of radiation source is therefore the number of particles registered by the detector in 100 s time the sum of two random quantities.

It is possible to show (more detailed explanation in [4]) that the relative error δ of the determination of mean value λ of number of pulses in stated time interval using one measurement only is reduced as $\frac{1}{\sqrt{\lambda}}$. With average of 25 pulses per 100 s would the relative error be about 20 % (!), with average of 100

pulses per 100 s it would only be 10 %.

To reduce the relative error of measurement, we have to use higher mean value of the particles number per the time interval – either by using longer time interval or more sensitive detector or stronger radiation source. For this reason a new demonstration radiation source DZZ Gama 300 kBq has been introduced.

4. Radiation source DZZ Gama 300 kBq

Demonstration source DZZ Gama 300 kBq, as well as school gamma radiation source from Gamabeta set is equipped with the emitter containing radionuclide ^{241}Am . Ten times higher emitter activity (300 kBq) enables us, even in such a short time as demonstration experiment in the physics lesson is, to show reliably even the dependence of number of particles registered in time unit by the detector on distance from the radiation source or on the thickness and material of shading barrier etc.

The demonstration radiation source DZZ Gama 300 kBq is aimed to be used by the professional teacher to perform the demonstration experiment and accompanies the former school radiation source SZZ Gama with ten times lower activity which is a part of the Gamabeta set and aimed for group and laboratory work of pupils and students.

DZZ Gama is of the same mechanical construction as the school radiation source SZZ Gama, therefore it is fully replaceable with the original source of Gamabeta set.



Figure 4. Demonstration gamma radiation source DZZ Gama 300 kBq

5. Experiments with the school gamma radiation sources

One of the most commonly performed experiments at schools is the investigation of the gamma radiation passing the shielding plates of different thickness and different material.

In the experiment, three brass plates from the GAMAbeta 2007 set of 0.5 mm thickness were used. The detector (equipped with Geiger-Müller tube) and radiation source DZZ Gama 300 kBq were both located in the set stand in a way that allowed them to be as close as possible. The plates were inserted (successively 0, 1, 2 and 3) into the groove of the stand. Always, there was once the number of pulses registered in detector measured for 100 s interval (Fig. 5). The estimated background correction was taken into account (the detector without radiation source detected about 35 pulses per 100 s).

We can see that each brass plate would reduce the passing gamma radiation with the energy of 60 keV by about one half (note the capability of materials to shield off the radiation depends on the energy of this radiation). By interpolating the exponential function e.g. in Excel, we can get for our numeric values for dependence of the number of the registered particles on the brass thickness (mm) this formula:

Based on this formula, we can try to estimate to what extent the gamma radiation passes out of the radiation source when the rotational brass shield on the radiation source is closed. Its thickness is 6 mm. If we substitute this value for x in the above formula, we get the value for the stated number of pulses: $N = 0.07$ pulses per 100 s. This is two orders of magnitude less than the value the detector would register from the background.

The plate of the thickness 0.5 mm would reduce the passing gamma radiation of the energy at 60 keV by about 1/3. The stainless steel is shielding the used gamma radiation worse than brass.

The sufficient activity of the demonstration radiation source DZZ Gama 300 kBq allows us to investigate in short time even the “sideways” radiation off the axis of the emitter. The bottom part of radiation source was equipped with paper section with angular scale with grade of 7.5. The radiation source with such protractor was then inserted into the stand in the distance about 4 cm from the detector and the rotating shield was oriented in such a way the radiation would leave the source through the larger opening. The number of particles was then measured per 50 s at different orientation of the source. The result

of the measurement shows the Fig. 7.

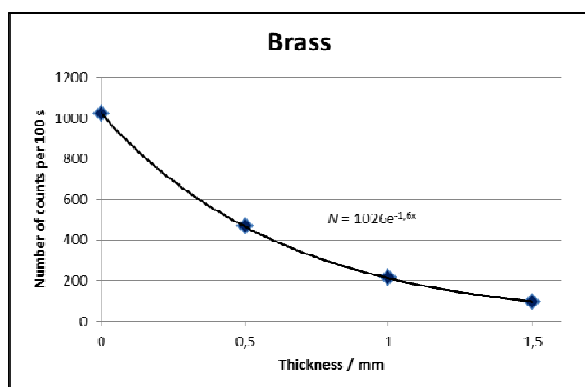

Figure 5. Gamma radiation shielding by brass plates

The measurement was repeated for the stainless steel shielding sheets as well (Fig. 6).

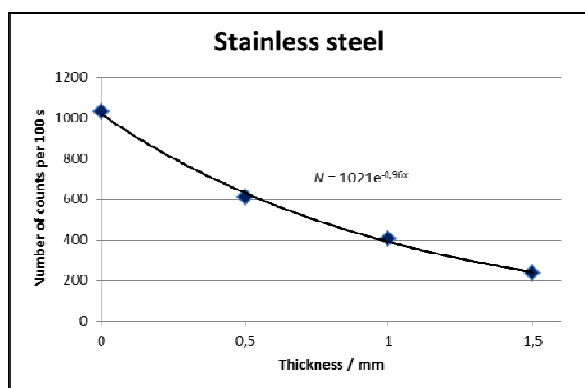

Figure 6. Gamma radiation shielding by stainless steel plates

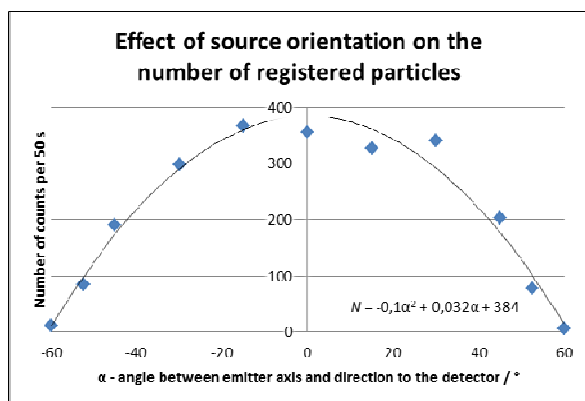

Figure 7. Effect of source orientation on the number of registered particles by the detector

The estimated background correction was taken into account (the detector without radiation source detected about 15 pulses per 50 s).

The measured dependence shows that the precise orientation of the axis of the emitter of the radiation source towards the detector is not

significant for the common school measurement. The drop of registered number of particles to the level of background is apparent already at the orientation of 60° which is caused by the experiment geometry.

6. Conclusion

The experiments mentioned in this article represent only a tiny share of possible experiments that can be performed using school radiation sources and simple school detectors.

School students are future users of radiation and therefore school or college is an ideal stage to instil a respect for the safe and proper use of radiation. Teaching about radiation helps people develop a balanced attitude towards the subject.

Providing students with “hands-on experience” with a variety of radiation sources offers many benefits for the teaching of science and technology [6].

As with any other potentially hazardous material or electrical appliance, it is necessary to follow some rules so that the radiation sources are used appropriately and safely.

7. References

- [1] Zilavý P. Gamabeta 2007 – souprava pro pokusy z jaderne fyziky. In: Sbornik konference Veletrh napadu ucitelu fyziky 12. Praha 2007. s. 183-186.
[http://vnuf.cz/sbornik/rocniky/Veletrh_12_\(Praha_2007\).pdf](http://vnuf.cz/sbornik/rocniky/Veletrh_12_(Praha_2007).pdf) [visited 17-May-2013]
- [2] <http://www.cez.cz/cs/vyzkum-a-vzdelavani/pro-pedagogy/materialy-pro-vyuku/gamabeta.html>
- [3] Act No. 18/1997 Coll. – Atomic Act
<http://www.sujb.cz/legislativa/zakony>
- [4] Maslan M, Machala L, Tucek J. Praktikum z atomove a jaderne fyziky. Univerzita Palackeho Olomouc; 2005
<http://apfyz.upol.cz/ucebnice/down/jaderka.pdf>
- [5] <http://kdt-38.karlov.mff.cuni.cz>
- [6] <http://www.arpana.gov.au/pubs/rps/RPS18.pdf>



CREATIVITY AND MOTIVATION IN PHYSICS EDUCATION

Marcela Chovancová

*Department of Physics, Faculty of Civil
Engineering, SUT,
Bratislava, Slovak Republic
marcela.chovancova@stuba.sk*

Abstract. *The article deals with motivation and creative problems. One of the ways may be nonconventional tasks. A part of the task description could be assigned in a pictorial form. The perception of the situation given by the picture is graphical and more intensive than verbal setting of the task. There is an option to use funny figures, full colour scheme, situations from real life or humour scenes. The verbal part of the picture has only supplementary function and consists mainly of questions for students to answer.*

Majority of essential data are hidden within the picture. A square grid is necessary to obtain input numeric data from the picture. This form of assignment can reduce the formality of problem solving. The student have to consider more carefully what is relevant to the solution. It is possible to find out or „read“ input data in two or three dimensions. Actual metrics are given in a particular problem. In one picture there could be used different metrics for variety of physical quantities.

In addition to an ordinary verbal task students have to use their knowledge to look for required hidden data in the picture. Most attributes are not given explicitly. Students should be aware of what data is required to solve the task and how to obtain the missing information (using metrics of the task). The pupils who have only theoretical knowledge might not be able to solve the task. They have to be able to transform their experience into the „physical language“.

Pictorial tasks occur very seldom in the process of education. Mostly they are used as an additional illustration to the verbal task. Students are not used to extracting any hidden information from pictures. Creative tasks should evoke students' deeper interest in physics.

Keywords. motivation pictorial task, motivational problem, centre of gravity, unconventional pendulum, forced vibrations,

resonance.

1. Motivational Pictorial Task

Motivational pictorial tasks could serve for enriching physics lessons. They could be used also as a pictorial suggestion for an experiment. See examples below from various parts of physics.

1.1. Stability and the Centre of Gravity (Fig. 1)

Is it possible to place a butterfly with its „pointed end“ on the muzzle of a curious dog, so that it stays on and even oscillates there? If it is not possible what is the minimum weight we have to put into orange dots of butterfly to make the situation in the Fig. 1 realistic?

To extend the range of experiments with centre of gravity we could use two different versions of the Fig. 2. First simple version consists of making a paper model of a butterfly from paper. Then using paper clips as weights on its wings, we can stabilise butterfly to stay on our finger or on a straw.

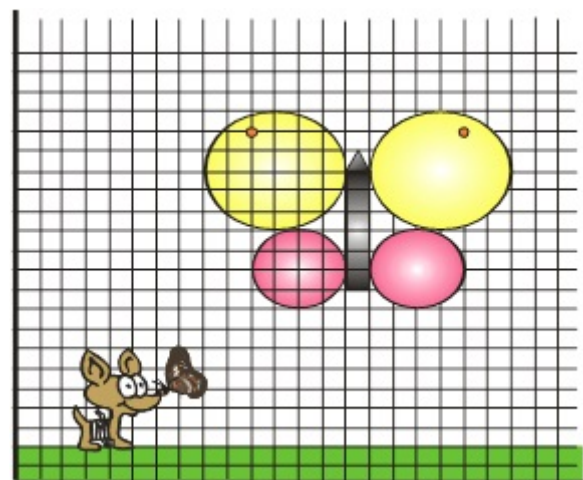

Figure 1. Centre of gravity

For the second version we would need a cardboard, two straws (for its antennae), two little balls, elastic band and adhesive tape. Using tape we will fix straws onto the butterfly in the position of its antennae. Then we thread the elastic band through the straws to fix the balls on the top of straws by making knots. By moving straws we will set up the stable position for the butterfly to “sit on” the top of the finger Fig 3.

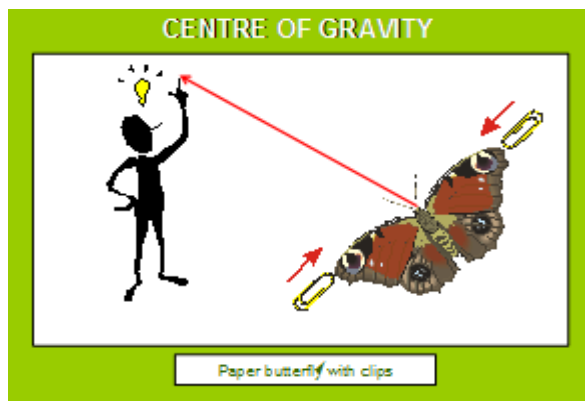

Figure 2. Finger and butterfly

1.2. Unconventional pendulum (Fig. 4)

A mosquito has decided to stop feeding on human blood and serve science instead. He wants to find out the speed of the water pushed through the syringe. For this purpose he has recycled a plastic bottle and modified it into a pendulum. This unconventional pendulum hit by the water started to oscillate with the time period of 1 second. What is the speed of the sprayed water from the syringe? (1 segment in the Fig. 4 is equivalent to 2 cm).

can with cherries' stones. What must be the speed of a cherry stone to hit the neck of the watering can exactly? What is the force we have to use to get the cherry stone moving with desired speed? Let's assume that the weight of a cherry stone is 0,3 g and „the hitting time“ is 0,05 s. 1 segment in Fig. 5 corresponds to the length of 10 cm.

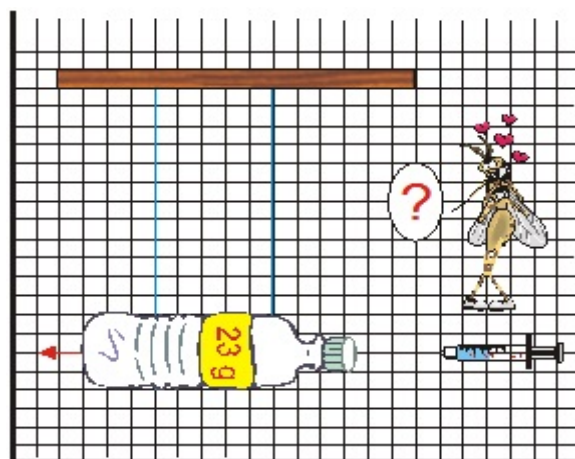

Figure 4. Unconventional Pendulum



Figure 3. Experiments with butterflies

1.3. Weighing (Fig. 5)

Thumbelina wants to find out her weight. Her father, a keen physicist, constructed an unconventional scale for this purpose. The Fig. 5 shows the scenario where the chessboard with pawns and Thumbelina is balanced. Find out her weight.

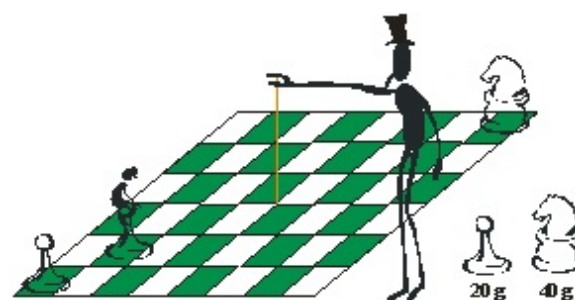

Figure 5. Weighing

1.4. Flick in the service of science (Fig. 6)

Old gardener is thinking about his future harvest of cherries. He has prepared a game for his grandchildren – flick-shooting into the watering

1.5. “Rescue Mission” (Fig. 7)

Tiny figures are trying to save the mug from falling down. As per situation shown in Fig. 7 can you say if they are going to succeed?

2. Motivational Problems

One of motivation “tools” in physics are experiments and unbelievable situations. To demonstrate this we would like introduce some of our experiments with instructions from various parts of physics.

2.1. The Resonance (Fig. 8)

One of my sporting tools can be used to demonstrate the resonance. It is a boxing tool connected to the mat on the floor. In addition we need an elastic band and a round box. The

boxing tool will serve for our experiment as a pendulum. We will need the rounded box to act as a harmonic forcing function. When the forcing frequency is close to the natural frequency of the pendulum the system will exhibit resonance.

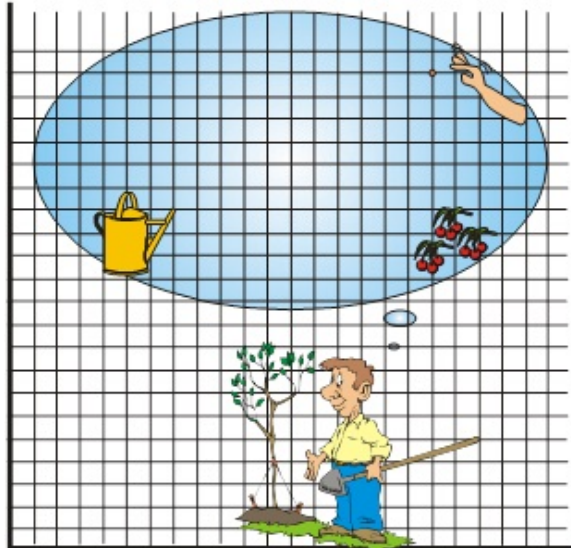

Figure 6. Striking range of the cherry stone

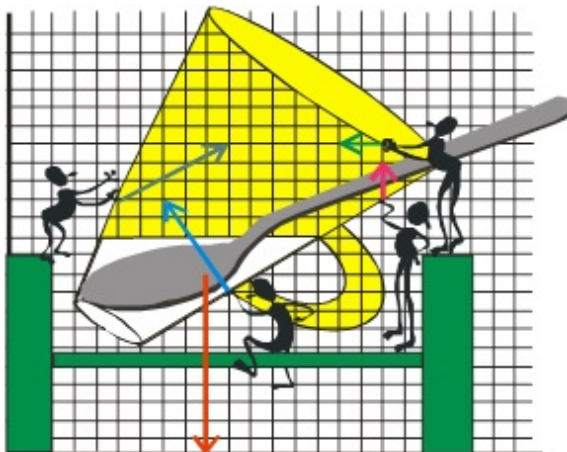

Figure 7. What is happening with the mug?

2.2. Balloon – Detective Story with “a Model”

Balloons – that's ideal entertainment for naughty kids with pins! But did you know that in some places even a pin is powerless? The balloon has one special place on its surface where it is “invulnerable”? How does a pin actually cause a balloon to burst? When we pierce an unblown balloon nothing happens. There will only be a small pinhole.

For simplicity we can imagine the surface of unblown balloon as small balls connected with elastic bands. In our model the piercing of

unblown balloon corresponds to a cut of one of the elastic bands. It means that the mutual bonds are disrupted without any other consequences. In this scenario two neighbouring balls are not connected but it doesn't influence the rest of bonds among other balls.

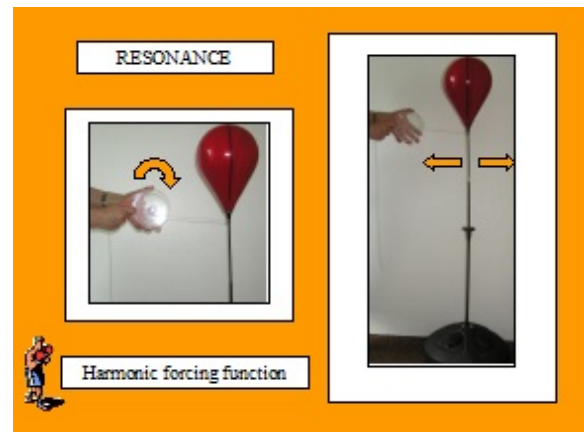

Figure 8. Resonance

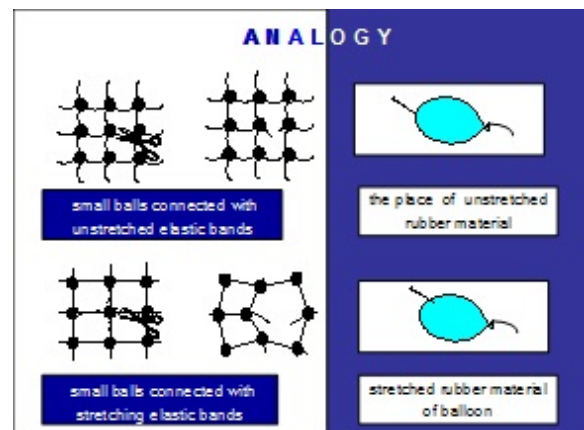

Figure 9. “Model” of the balloon

The swelling of the balloon and stretching of rubber material represents stretching of elastic bands between balls – the surface of the balloon is expanded. Forces act on each of the balls from the elastic bands surrounding them but they cancel each other out. The resultant force on each of the balls is zero. That's why each ball is idle. What will happen if we interrupt one of the elastic bands? The equilibrium of the system is violated. The affected ball starts moving in the direction of the resultant force. If you look at the Fig. 9 you can see that this situation impacts all other balls as well. Some of the elastic bands start stretching too much and they are ruptured. It is a snowball effect and more elastic bands are parted. The grid is torn. The balloon burst. Even when the balloon is fully blown up there is one particular place on its surface where the

rubber material is not fully stretched. It is the place where the rubber material is much darker. If we penetrate balloon in this particular place it doesn't burst. This situation corresponds to the first scenario. We can see a pinhole but the balloon stays whole.

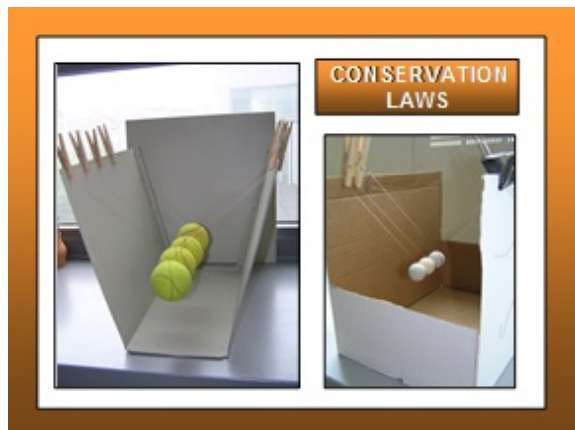

Figure 11. Experiments with balls and marbles

The reason for a balloon to have this spot is the way of its production. When we look at the unblown balloon we can find the spot with a cruder layer of rubber material. We have to take into account one another factor – the shape of the unblown balloon is not a circle but an oblong one. The pressure of the compressed air in the balloon causes the stretching of the rubber material of its surface but not evenly. „The cruder spot“ resists more and that's why it stretches less than other parts of the surface. In our model this could be represented by the cruder elastic bands in this place. There is a lesson learned for our little mischiefs. Using a pin to blow out balloon has its well-known effect. But definitely more impressive surprise for the spectators would be to have a fully blown balloon pierced with a pin and stay whole.

2.3. Principles of Conservation, Handmade Experiment (Fig. 11)

We are going to introduce our own simple execution of well-known experiment on Principles of Conservation using needless household things! We are using a cover from an old computer as a holder. We need at least 3 old tennis balls. Then we need thread and clothes pegs. See the execution of the experiment in Figure 10. We need to divert one of the balls and then watch the consequences. Then we will repeat the process with two balls, three balls, etc. Instead of tennis balls we can use marbles from

old computer mice. Alternatively we can have a modified box as a stand. Instead of clothes pegs we can use office clips. Further options of carrying out this experiment are in the hands of students and their imagination.

3. Conclusion

Pictorial tasks and experiments could serve for reaching physics lessons and evoke student's deeper interest in physics.

4. Acknowledgements

We acknowledge our family, colleagues and my friend in Great Britain.

5. References

- [1] Baník I, Baník R, Chovancová M, Lukovičová J. Physics in Non-traditional Way 2–Hydromechanics, Waves, Thermodynamics, STU, Bratislava, 2008, p. 411.
- [2] Onderová L, Kireš M, Ješková Z. The Physics around us in the experiments and problems. In: Veletrh nápadů učitelů fyziky 10: Praha, 2006. p. 70-74.
- [3] Onderová L. The Balloon and Physics. In: Veletrh nápadů učitelů fyziky 12. Praha, 2007. p. 137-141.
- [4] Gabková J, Halusková S. Inter disciplinary relation at the education at the laboratory exercises. In New trends in physics Brno, 2012. p. 205-207.
- [5] Holá O. Natural science in our life today and tomorrow. In: Badania w dydaktyce fizyki. Krakow, 2012. p. 22-26.



HOME EXPERIMENTS OF PUPILS AND STUDENTS - A WAY TO INCREASE THE INTEREST OF YOUNG PEOPLE IN PHYSICS, ENGINEERING AND SCIENCE

I. Baník, M. Chovancová, G. Pavlendová

Department of Physics, Faculty of Civil Engineering, SUT, Slovak Republic
ivan.banik@stuba.sk,
marcela.chovancova@stuba.sk,
gabriela.pavlendova@stuba.sk

Abstract. *One of the ways how to enhance interest in physics is to enforce the experimental nature of teaching this subject, namely by promoting the simple experiments, at least such which can be carried out at home. My presentation is devoted to the propagation and/or description of the simple home physical experiments. The methods help students to eliminate formal study and enable better understanding of notions and laws of physics are presented.*

Keywords. Physical experiments, Simple experiments, Teacher training, Physics education

1. Introduction

Technical progress and namely the development of advanced technologies is unthinkable without a profound knowledge of the laws of nature - without understanding the various physical phenomena and contexts. Just to mention a variety of laser measurement technology and equipment advanced information technology, computer-controlled safety systems of nuclear reactors, medical tomographic technique, transmission in space and astronomy, and other facilities. But physics with its capabilities influences not only the top technical equipment, but also the daily human life. Just remember even a video technology and CD-systems, personal computers, microwave ovens, mobile phones, car locking devices, etc. Physics strongly influences also other sciences, enables advances in biology, medicine and so on. The development of physics as a discipline will require highly qualified professionals. But given the fact that physical methods are being increasingly used in

other areas of science and technology, the role of physical education is extremely important. To achieve these objectives not only teachers should be involved, but also other segments of society, in particular parents and relatives, media and various social institutions and society as a whole. The general climate of the society should orient youth towards a positive relationship to knowledge.

The subject physics is usually too difficult for children; it is needed to make the physics-teaching more interesting and accessible. There is no universal recipe for successful learning and teaching process. Many good and healthy ideas are nevertheless known. One most significant point is the problem of motivation. How to motivate the pupils, resp. students to be interested in concerning problem? One way to enhance the interest in physics is to enforce experimental character of physics teaching and namely by promotion of simple experiments.

Activities of a student concerning experiments in physics may not be restricted either inside physical laboratory or by the time spent in it. Even aids used in experiments do not have to resemble to those in the labs. A student's approach to a laboratory device is usually complex. He feels presence of a wall between his own home possibilities and laboratory instruments. At the same time many experiments and measurements can be done at home using simple aids. Such a possibility makes descriptions of an experiment more attractive. It provokes a student to use home-made aids to look for connections among data.

One of the ways how to enhance interest in physics is to enforce the experimental nature of teaching this subject, namely by promoting the simple experiments, at least such which can be carried out at home. Our presentation is devoted to the propagation and/or description of the simple home physical experiments. Simple physics experiment did not stop to have meaning today and it will never stop. It's sort of breast milk of school physics. Experimental physical activity of students in the household positively affects the attitude of society towards the learning of this subject.

2. Some home experiments and measurements

Inertia of bodies

Place a bottle full of water on the end of table.

Tie a thread around the neck of the bottle. When pulling the thread slowly, the bottle starts moving or even topples over. When pulling the thread abruptly, it breaks without the bottle moving.

Law of Conservation of Momentum

You need two identical glass balls. Place one of them on a smooth table surface, the other one will serve as a bullet you will shoot in a defined direction at the first ball. The direction of the bullet is determined by the edge of a book laid on the table along which you will shoot.

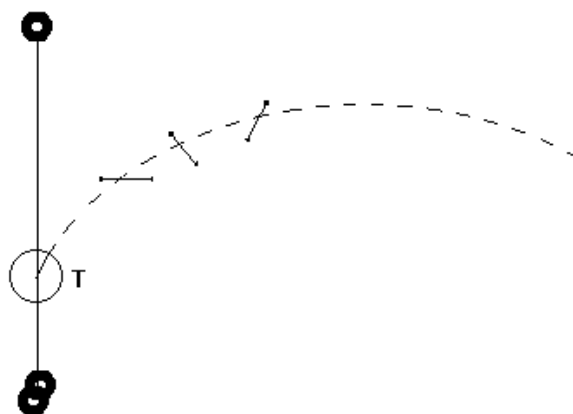

Figure 1.

Observe the motion of the balls for a short period of the time after a clash, then stop both balls by putting your hands on them (one hand on each ball). This will show you the motion of the balls after the clash. The velocity of the particular ball is directly proportional to the length of its track from the points of clash to the point where you have stopped it. Mark the vectors of motion of the both balls after the clash on the table. By adding these two vectors vectorially, you will obtain a vector, which represents the direction of the momentum of the system after the clash. This vector is parallel with the „aiming edge“ of the book i.e. with the total momentum of the system before the clash.

The Motion of the Centre of Gravity (CG) in a Uniform Gravitational Field

The motion of CG in uniform gravitational field of two-particle system can be examined in a way as it is shown in the Fig. 1. Two nuts are connected to each other by a silk thread. The ratio $m_1/m_2 = 1/2$, then CG is located at one third a distance from the heavier nut. To make CG visible a table tennis ball is placed there. If this system is thrown up in such a way that both nuts

also rotate in a vertical plane the ball moves in general along a parabolic path. This can be shown e.g. using many successive photographs of the motions.

Angular Momentum Conservation Law

We can demonstrate conservation of angular momentum by this simple experiment. A wire pass through a short tube. At the one end of wire a metallic nut is bended (see Fig. 2). We hold the tube in one hand and the other end of wire in second one. Then, we bring the nut in rotational motion in a vertical plane. Pulling the wire during the motion, we slowly shorten the rotating part of the wire, by this means radius of rotation decreases and velocity of the motion increases owing to conservation of angular momentum.

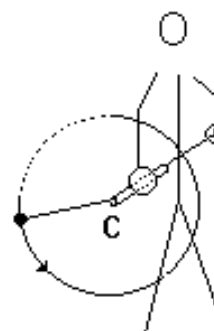

Figure 2.

In this experiment the net force acting on the screw is nearly directed to the end C of the tube along the wire. Angular momentum with respect to this point is nearly constant and its magnitude is mvr , where r is length of the rotating part of the wire and v - velocity of the screw assuming that, we slowly shorten the rotating part of the wire. Angular momentum conservation law in this case can be written as follows $mvr = L = const$, or $v = L /mr$. From the last formula one can see that velocity v of the rotating screw increases when the rotating part of the wire r decreases.

Resonance

We describe one simple way in which resonance can be observed and character of the resonant curve can be found. This method one can apply also in domestic conditions which should provoke a student to prepare a do experiment himself. It is not going on precise and long time measurement but rather we should illustrate essence of effect. A student has to understand

that proper physical notions and mathematical relations describe quantitatively a given situation.

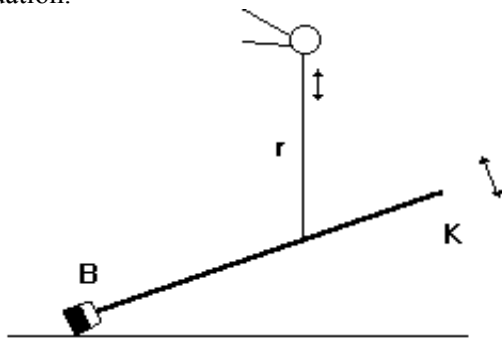

Figure 3.

Arrangement of our experiment is shown in the Fig. 3. One end of a besom M lies on the ground. The besom in its initial position is suspended on the rubber which one holds in his hand, as seen in Fig. 3. An oscillatory motion of the hand in vertical direction brings the besom also in its own oscillatory motion. We observe the amplitude of motion of the upper end of the besom (broom). This significantly depends on frequency of the hand motion. The oscillatory motion of the hand must be somehow restricted (using a ring etc...) to achieve a constant amplitude of the driving force

Coupled Oscillators

Properties of two coupled oscillators can be demonstrated in a way which is shown in the Fig. 4. A reverse chair rests on a table with a loop made from rubber and stretched on their legs.

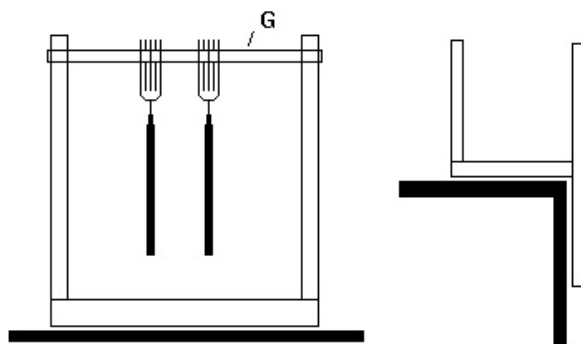

Figure 4.

This serves as a hanger for two forks. If one fork we stress to swing then oscillations are transmitted to the other fork and backwards etc. We can observe energy exchange between swinging forks. The strength of coupling of both

oscillators we can change either by changing the distance between forks or changing the stress of the rubber stripe. As the other example of two coupled oscillators with magnetic coupling can serve two cylindrical ferrite hanging on an iron rod. These can swing in planes orthogonal to horizontal rod. The change of distance between ferrite changes the strength of magnetic coupling.

A Wooden Board and a Coin

A board is in a horizontal initial position. One end of the board rests on the table, the other one – on the hand. A coin lies on upper side of the board (see Fig. 5). After dropping one end of the board we follow the motion of the coin until we catch the dropping board in the hand again.

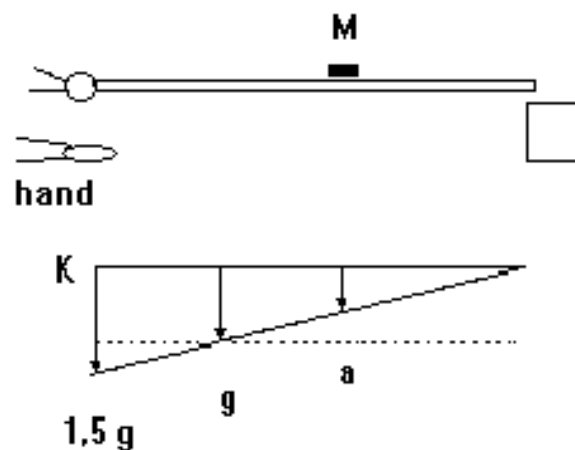

Figure 5.

Changing the position of the coin on the board we observe that at some position the coin tinkles. The problem rests in determining position at which the coin tinkles. The region of tinkling corresponds to one third of the board length measured from its dropping end. In this region the acceleration of any point is greater than g (acceleration due to gravity). That is why the coin falls „slowly“. If we stop the fall of the board the coin strikes on the board and becomes a source of a sound. An explanation of this effect is involved in solution of an equation of motion. The initial conditions of the experiment can be changed by changing points of the fulcrum and then looking for the region of a tinkle.

Discovering the nature of sound by means of ruler

You can discover the nature of sound using an

ordinary celluloid ruler. Press the ruler on the table so that a part of it overlaps the end of the table. By lifting the portion overlapping the table and the releasing it, it will start to give a sound. The shorter these part the higher the tone.

Segner wheel, using a plastic bag

Fill a little plastic bag with water, tie its upper end with a thread by which will hold the bag (Fig. 6). Perforate the bag at two opposite points close to the bottom so that water squirts out in opposite directions. With agreeing momentums of force, the bag will start to rotate. Do the experiment over a wash basin, tub or outside.

Segner wheel, using a tin

Remove the top cover of the tin, make two cuts parallel with the axis of the tin (approximately 1 cm long) at two opposite points close to the bottom. Bend the tin around the cuts in such manner that the water squirts out tangentially to the bottom of the tin in opposite directions. Hang the tin by a thread. Fill the tin with water while stopping the flow of water with your fingers. After removing yours fingers, the thin will start to rotate.

Piezoelectric lighter

High electric potential difference can be generated by using piezoelectric lighter which we can observe in the following experiment (Fig. 7). Hold a knife with a plastic handle in one hand in a such a manner, that the blade overlaps the end of the table. Put a folder piece of an aluminium foil on the blade of the knife. Touch the point of the knife with one pole of the piezoelectric lighter. Push its trigger and you will see the two halves of the foil separating for as long as the lighter is on.

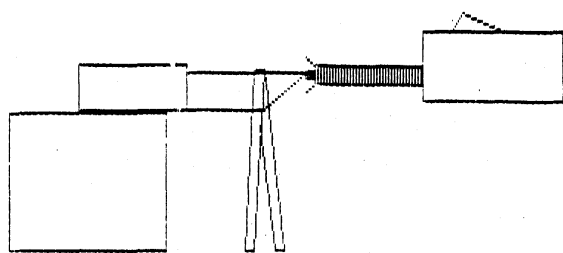

Figure 7. Self inductance show in a soldering machine

You can observe a relatively high potential difference being generate due to self inductance in the primary winding of an ordinary soldering machine (Fig. 8). While holding both pegs of the plug of the soldering machine in your fingers, touch both poles of 4,5 V battery with the pegs. After moving the pegs away from the battery, you will sense a slight shock in yours fingers. You can do the same with a hair drier, vacuum cleaner etc.

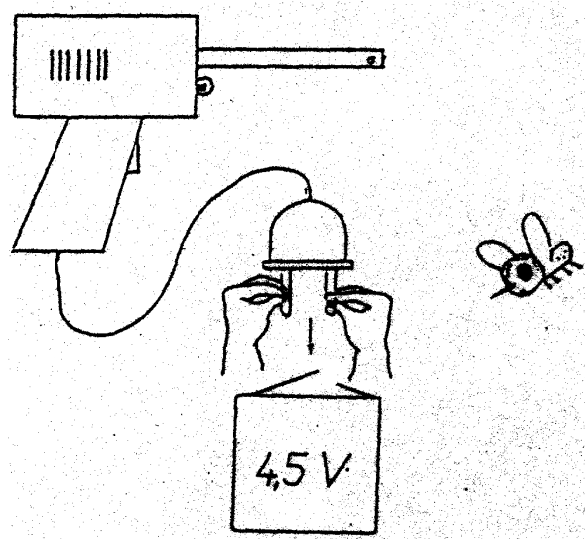

Figure 8.

Glass cup works as a light conductor

Place a big glass cup (no gilded brim) bottom up on the table and light bulb close to the margin of the bottom of the glass. While moving the bulb, you will see that in certain positions the whole brim upon which glass stands will shine. The whole of the curved cylindrical glass wall of the cup serves as a light conductor through which the light flows.

How to make a wooden mirror - an unusual way to illustrate total internal Reflection

You will need thin piece of wood, the polythene pocket and the container of water. Total internal reflection can occur when a ray of light passes from water to air.

Follow these steps:

1. Pose the question: how can you make a mirror from a piece of wood?
2. Place the wood in the polythene pocket

and then into the water, making sure that no water is able to enter.

3. Vary the angle of the wood in the water. At a particular angle the part of the wood that is submerged will act like a mirror.

So what happened? At a particular angle, total internal reflection occurs in the layer of air, between the wood and the polythene, so that it behaves like a mirror.

Real depth and apparent depth - finding the refractive index of a liquid

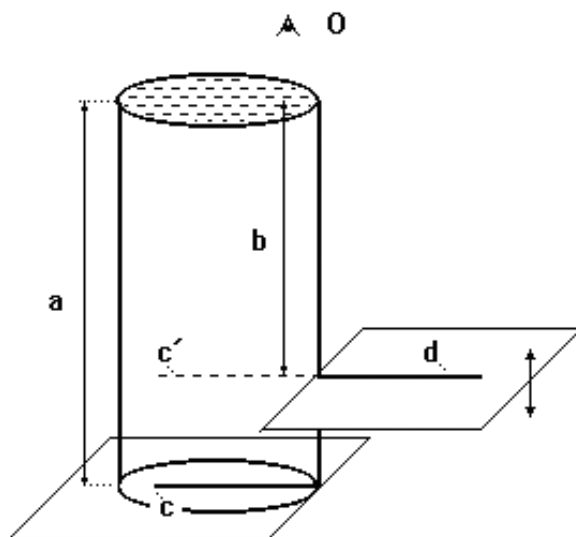

Figure 9.

You will need: a deep glass container and two pieces of paper (Fig. 9). Follow these steps:

1. Draw a straight line on both pieces of paper.
2. Place one of the sheets under the glass container.
3. Looking down into the container from above, raise the second sheet of paper until the two lines appear (coincide with no parallax).
4. Record the real and apparent depths.
5. Calculate the refractive index $n = a/b$.

Experiment with a compact disc

If we highlight a small area S of CD disc with the light of classical bulb, (as shown Fig. 10), the angle α under which the eye O registers rays corresponding to the interference maximum of the first order will be different for various colours. The wavelength λ corresponding to the colour the eye registers looking at the area S, can

be calculated as follows $\lambda = O_1O_2 \cdot \sin \alpha$, where $O_1O_2 = 1,6 \mu\text{m}$ is the lattice constant of the CD disc (as reflecting optical lattice).

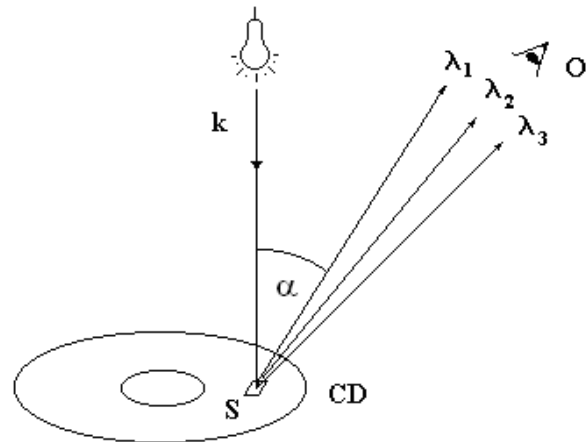

Figure 10.

Put a compact disc on the table and stand over it so, that your eye is above the centre of disc at a distance of aprox. 60 cm (Fig. 11). Place the bulb of a pocket torch without reflector in the middle of the line between your eye and the disc. After adjusting the position of the bulb, a beautiful shining circular lattice spectrum of the first or second order respectively can be seen on the disc, depending on the position (Fig. 12).

TV screen seen through a magnifying glass

You can discover the secret of colour composition used in TV image if looking through a magnifying glass, at a colour TV screen. You will see tree basic colours which make the resulting picture. Intensity and relative ratios of particular colours vary on TV broadcast.

An unusual method to demonstrate interference

Follow these steps:

1. Sprinkle a thin layer of fine dirt onto the shaving mirror. A suspension of fine mud or chalk smeared onto the mirror and allowed to dry should also work, while a film of milk allowed to dry on the mirror is a good alternative (Fig. 13).
2. Remove the head of the torch to expose the bulb, which should be clear so that the filament acts as a small point-source of bright light. Look directly at the mirror while holding the light source close to your temple.

Self inductance show in a soldering machine

You can observe a relatively high potential difference being generated due to self inductance in the primary winding of an ordinary soldering machine (Fig. 8). While holding both pegs of the plug of the soldering machine in your fingers, touch both poles of 4,5 V battery with the pegs. After moving the pegs away from the battery, you will sense a slight shock in your fingers. You can do the same with a hair drier, vacuum cleaner etc.

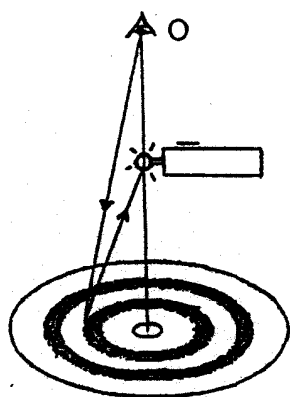

Figure 11.

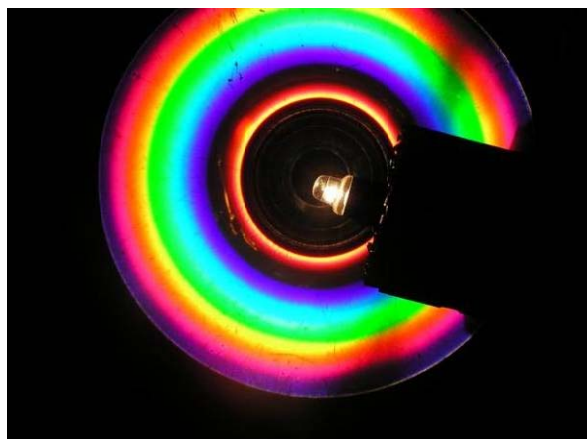

Figure 12.

3. Conclusion

The simple experiments help to eliminate the formalistic approach to the subject matter. This represents the valuable tool in the fight against the verbal approach to physics. Interesting physics must begin by science teacher training. The students - the future teachers - should be guided to take a creative approach to such methodologies to be able to suggest and verify the new home experiments. Such approach

would lead to the systematic life-long improving of these methods. The teachers and undergraduates of teachers training should have the sufficient professional publications focused on such forms of teaching available. However, the specialized literature should be offered to students at secondary schools as well.

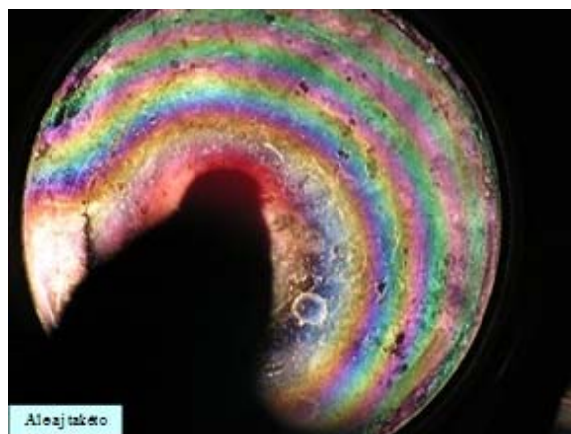

Figure 13.

4. References

- [1] Baník I, Baník R, Chovancová M. Physical Kaleidoscope, SUT, Bratislava 2008, p. 336, 2008.
- [2] Baník I, Baník R, Chovancová M. Kaleidoscope of a Physics Teacher, No. 1-10, 1992-2000, MC, Bratislava, p.1400.
- [3] Baník I, Baník R, Baník Ig. Physics in Non-traditional Way 1 – Mechanics, STU, Bratislava, 1997, p. 369.
- [4] Baník I, Baník R, Chovancová M, Lukovičová J. Physics in Non-traditional Way 2–Hydromechanics, Waves, Thermodynamics, STU, Bratislava, 2008, p.411.
- [5] Ješková Z, Kireš M. Experiments on the Physics of motion In: Science on Stage 2: Book of Project Summaries and Nat. Reports. 2007.
- [6] Halusková S. Remotely real experiment. In Physics Teaching in Engineering Education. PTEE2009, Wrocław 2009, p. 67-70.
- [7] Hockicko P, Tarjániová G, Müllerová J. How to attract the interest of school-age children in science, 16-th Conf. of Czech and Slovak Physicists, Hradec Králové 2009, 394-399.



IMPLICATIONS FOR INSTRUCTION IN INCLINED PLANE HANDS-ON EXPERIMENT

Yun-Ju Chiu, Feng-Yi Chen
General Education Center, Chang Gung
University,
Tao-Yuan, Taiwan
yjchiu@mail.cgu.edu.tw,
jocelyn@mail.cgu.edu.tw

Abstract. *The inclined plane experiment is often regarded too simple to be included into the College introductory physics hands-on labs. This paper aims to illustrate the design of the experiment and teaching strategies pertaining to teachers' instruction and students' mistakes during the experiment.*

The subjects are college freshmen majoring in engineering. Experiment equipment includes a piece of 120 cm aluminium track, a marble, a protractor, a ruler and a timekeeper. Students are required to develop a method to measure the velocity of the rolling marble when it reaches an appointed point in this inclined aluminium track. Three equations of constant acceleration, which students have learned in high school, should be applied to calculate the velocity.

This inquiry-based experiment engages students' interests by getting them to explore subjects for themselves rather than inculcate learning through the more traditional teaching method. It also helps students to formulate their ideas and offers students the opportunity to develop initiative, problem solving, decision-making ability, and better their experimental skills. The student's misconceptions prior to the experiment will also be focused on for improving teachers' instruction.

Keywords. physics, misconception, inclined plane experiment, experimental skill.

1. Introduction

The experiment of inclined plane, which Galileo successfully carried out in 1600s, is often the first experiment that students learn in physics class. It is often regarded to be too simple to be included into the curriculum of freshmen physics laboratory experiment.

The traditional experiment hand-outs for students

are usually designed like cookbooks in Taiwan. To finish an experiment, students just follow the well-designed procedure step by step and fill in data into the blanks provided. Inquiry learning is instead an active process, where progress is assessed by how well students develop experimental and analytical skills rather than how precise their experiment results are.

In this inclined plane experiment, students are required to develop a method to measure the velocity and acceleration of marbles rolling down a ramp. Three equations of constant acceleration and concepts of average velocity, which they have learned in high school curriculum, should be applied. Through this experiment, students will be able to understand how scientists use their background knowledge of principles, concepts, and theories, together with the skills of scientific process to prove their hypotheses.

This paper will illustrate the experimental design and pedagogy of the inclined plane experiment.

2. The study

2.1. Subjects

The subjects are 82 college freshmen majoring in engineering. These students will be divided into two classes and each class will be instructed by a faculty (the author) and assisted by a TA. Further, each class will be split into several groups, three students as a group.

This lab includes a pretest, group hands-on experiments, and written reports after the hands-on experiment.

2.2. Pretest

This is a paper-and-pencil test. Students are given a short demonstration before the test begins. After the demonstration, students must check a box and explain why they choose the answer. The pretest is designed to give rise to the student's thinking before they do the experiments.

The five points a, d, c, e, b are equally-divided as you see (Figure 1). The marble is released from point i as I demonstrate.

If I measure the distance between point a and point b, Δx_{ab} , and the time interval Δt_{ab} , then we can get the average velocity V_{ab} equals Δx_{ab} divided by the time interval Δt_{ab} . Similarly, we can get the V_{de} using Δx_{de} divided by the time interval Δt_{de} . In addition to V_{ab} and V_{de} , V_c is the

marble's velocity when it passes point c. Please check a box and write the reason for your answer if I release the marble from point i and it will rolls down the track and passes each point (a,d,c,e,b). Following are my questions.

Q1. Does the average velocity V_{ab} equal V_c ?

- Yes. If so, why?
- No. How do you measure the velocity V_c ?

Q2. Does the average velocity V_{de} equal V_c ?

- Yes. If so, why?
- No. How do you measure the velocity V_c ?

Q3. Do you think the two velocities of V_{ab} and V_{de} will be the same? Why?

Q4. If the marble rolls down from point a, does V_{ab} still equal the average velocity V_{ab} released from point i ?

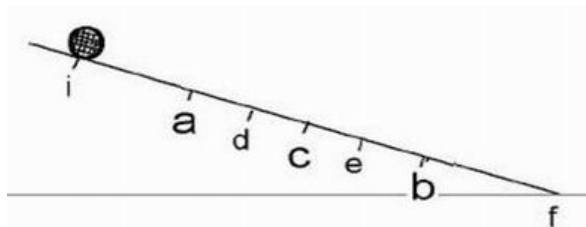

Figure 1. The inclined plane picture in the pretest.

2.3. Materials and procedure of the hands-on experiment

After the pretest we don't immediately disclose the answers, instead, we let students find the answers through the hands-on lab. Thus, they are required to develop a method to measure the velocity of the rolling marble when it reaches an appointed point c in this inclined aluminum track. Three equations of constant acceleration (Figure 2), which students have learned in high school, should be applied to calculate the velocity. Experiment equipment includes a piece of 120 cm aluminum track, a marble, a protractor, a ruler and a timekeeper for each group.

Procedure

- a). Mark the points with these measurements like in the picture (Figure 2).
- b). Design the method by which to carry out the experiment. Keep in mind that the marble will always be released from point i.

- c). Release the marble from point i and measure the two velocities of V_{ab} and V_{de} . Are they equal to each other?
- d). Release the marble from point i and measure the marble's velocity when it passes point c. Does V_{ab} equal V_c ?

After the operation, students must finish a brief report which must include the points as below.

- a). Methods and procedures.
- e). Calculate the data from the actual experiment and then compare it to the data calculated from the theoretical formula.
- f). Discuss the experiment as well as questions and problems encountered from the experiment.
- g). Write a short essay on what you have learned from carrying out this experiment.

3. Findings and discussion

3.1. Students' common misconceptions in the pretest

Two common misconceptions may be found in the pretest (Table 1). First, 57% students assume that the average velocity equals the instantaneous velocity of the mid point ($V_{ab} = V_c$). Second, 56% students tend to think that the two velocities are equal ($V_{ab} = V_{de}$).

3.2 Can students really see the answer from doing the experiment?

Is the average velocity equal to the midpoint's velocity? Can it be determined from their experiment data?

Students tend to reach their verdict on the outcome of the experiments their prior beliefs. That is, if the students believe that the two velocities are equal, then, even though the results are different their answers remain affirmative. Despite contradicting it themselves, most students assert that errors of measurement occur in the experiments.

It is almost a mission impossible for these students to see the answer from the experiment directly: Whether the two velocities are equal is not determined by their prior beliefs. Doing the experiment prompts them to think about the physics involved. Therefore, it is an opportune moment to give rise to panel discussion and peer instructions.

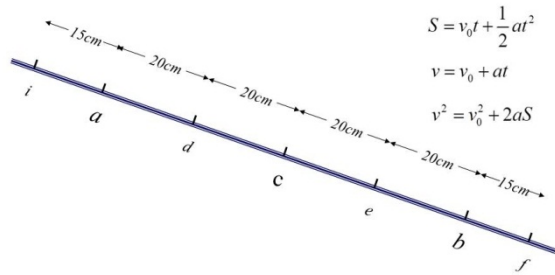

Figure 2. The given picture of the hands-on lab.

	Q1&Q2: Is V_{ab} equal to V_c ?		
	Yes	No*	Total
Q3: Is V_{ab} equal to V_{de} ?			
Yes	39	7	46(56.1%)
No*	8	28*	36(43.9%)
Total	47(57.3%)	35(42.7%)	82

*correct answer.

Table 1. Number of students in the pretest questions (n=82)

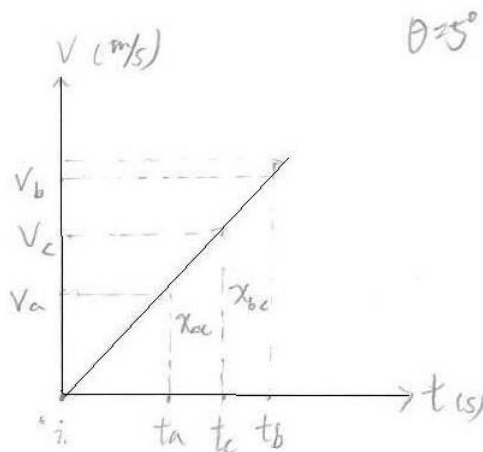

Figure 3. Some students draw the incorrect v-t graph to support $V_{ab} = V_c$.

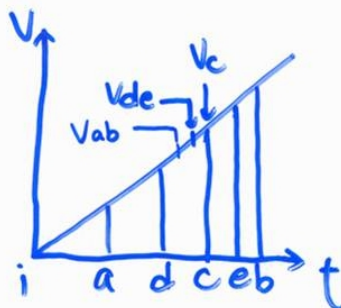

Figure 4. The v-t graph shows that the velocities (V_{ab} , V_{de} and V_c) are different.

Some of the students draw the incorrect v-t graph (Figure 3) to support their opinion that average

velocity V_{ab} equals the midpoint's velocity V_c . They do not pay attention to the unequal time intervals in this experiment. It takes time for students to argue and find out their misconceptions. After the drastic group discussion, some students give up their misconceptions and then draw the correct v-t graph as Figure 4.

3.3. Which is more important, easier to calculate or easier to measure?

Most groups set their track to an angle of 30 degrees in the beginning. Then they found the slope too steep to measure the short time intervals. Some groups reduced the angle to slow down the marble, and then found it easier to measure time intervals. Some groups still insisted on 30 degree because they think it easier to calculate. For those students, easy calculation is the most important factor they take into account.

3.4. Some students do not know how to use a protractor

It is surprised to find some students make mistakes when they set up the protractor to read the angle between the table and the track (Figure 5). For these students, they seldom have real experiences of measuring the angles because the hands-on operation rarely put into practice in high school. As you can see in Figure 6, a number of students read the data from point A, while other students read the data from point B.

3.5. Where do the errors come from?

In the process and from their reports, we found students making many mistakes in: (1) data recording and computing; (2) measuring (length, angle and time); (3) calculation and making use of the formula. Nevertheless, they did not blame themselves for their own mistakes in calculation or measurement but attributed the mistakes to the inaccuracy of the experimental instruments and existence of friction and air-resistance. It's difficult for students to differentiate which error comes from imprecise or inaccurate factors. Only when students are able to carry out the experiment precisely and accurately can the teacher reveal the further concept that the marble's acceleration is not $g \sin \theta$ because the marble is rolling not sliding down the track.



Figure 5. A student set up the protractor to measure the angle.

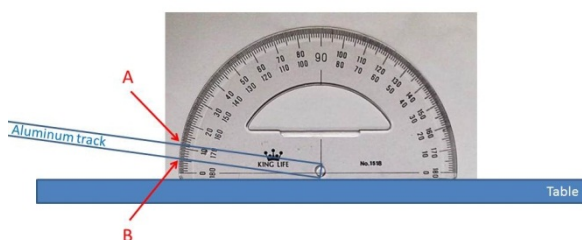

Figure 6. The illustration of Figure 5. A number of students read the data A, the others read the data B.

4. Implications for instruction

Three phases are explored through this hands-on operation. First, it helps students to clear their concepts of three equations of constant acceleration, the resolution of forces along a ramp, the meaning of average velocity and so on. Second, it reminds students to reflect on the weaknesses of their experimental skills such as the measurement of angles and data processing. In this inclined plane experiment, we find that most mistakes come from students' poor measuring skills, incorrect calculation, inadequate reasoning, and misunderstanding of the three equations of constant acceleration.

Third, it leads students to question the role of the static friction and explore why and how Galileo do this experiment.

This is a kind of inquiry-based learning. This hands-on operation encourages students to use their initiative instead of rote learning. In our lab, greater efforts have been made to engage students' interests in exploring physics concepts by themselves rather than inculcate learning through the more traditional teaching method.

Whether the inquiry-based learning is successful depends on the teachers. The role of the teachers in the inquiry-based learning is very important.

They must help students to pose questions and identify mistakes they made. Most mistakes come from students' poor skills, calculation by mistake, inadequate reasoning, misunderstanding, misconceptions, and the lack of background knowledge. After finding such mistakes, teachers must help students to solve these problems.

Inquiry-based teaching allows teachers to learn about their students—what they already know, what misunderstandings they may have, and how their minds work. There are some skills for teachers when using inquiry. They must learn what hints must to give as well as what not to tell students. They must know how to use the strategy of cognitive conflict and help students to collaborate in solving problems together. Knowing how to tolerate ambiguity and use mistakes constructively is also important.

Hands-on operating in trial and error and then finding mistakes in the process are of great help for active learning. In this study, we found the inclined plane hands-on labs can help students to reflect on the weaknesses of their own methods and concepts. It also helps students to formulate their ideas and offer students the opportunity to develop initiative, problem solving, decision-making, and research skills.

5. Acknowledgments

I deeply appreciate the support and grants (Grant NSC101-2511-S-182 -005 -) I have received from the National Science Council.

6. References (and Notes)

- [1] Trowbridge DE and McDermott LC (1980). Investigation of student understanding of the concept of velocity in one dimension. *Am. J. Phys.* 48(12), 1020.
- [2] Trowbridge DE and McDermott LC. (1981). Investigation of student understanding of the concept of acceleration in one dimension. *Am. J. Phys.* 49(3), 242.
- [3] Wemyss T and Kampen P. (2013). Categorization of first-year university students' interpretations of numerical linear distance-time graphs. *Phys. Rev. ST Physics Ed. Research* 9, 010107.



CLASSIFICATION AND MEASUREMENT AS A TOOL FOR INQUIRY-BASED APPROACH IN SCIENCE EDUCATION

Mária Orolínová

*Department of Chemistry, Faculty of Education, University in Trnava, Slovakia
morolin@truni.sk*

Abstract. *In this contribution we present different ways of measuring used to solve science issues by children in lower secondary level. Measurement is the assignment of numbers to objects or phenomena and is used for comparison and classification. It is associated with the use of measuring tools that are used to quantify the measured property.*

The measuring can be realized in a formal or informal way. The formal measurement uses specific standards as well as specific devices for measuring. The informal measurement uses improvised dimensions and tools.

Lower level measurements are based on detection frequency (nominal scales) and order (ordinal scales). Higher level of measuring is using interval and proportional scales, which are parametric.

Nominal scales are based on classifying items into groups in accordance to some criteria. Ordinal scaling concerns the possibility that all objects of a particular class can be sorted (ascending or descending) according to the defined properties.

Interval scales have all the characteristics of nominal and ordinal scales, especially the characteristics of the order and also the size of the difference between the measured objects.

The most perfect level of measurement is represented by proportional (ratio) scale, also called the absolute scale. The second name (absolute scale) is implied by the fact that the scales have absolute zero. It enables to perform a comparison of ratios.

The article includes the examples of different levels of measuring used by children in inquiry-based process of science learning. The mostly used scales are of the lower level and the dimensions are prevalingly informal. The imperfect scale and improvised device used for measurement surprisingly leads to better understanding of measuring principles.

Keywords. IBSE, measurement, scales, science skills

1. Introduction

The skills involved in the scientific process can be divided into two categories: the basic skills (observation, inferring, classification, scientific communication, measurement, prediction) and combined skills (determining and controlling variables, setting and testing up a hypothesis, interpreting data, defining, experimentation and creating a model). [2]

It is known that the measurement and the scales are used in an intuitive way in inquiry based science education. However the teacher should be the one who knows what type of scaling is used and what additional operations can be applied to handle the results. There is also great opportunity to precise this scientific skill and there is large space for improvement.

The measurement is defined as the assignment of numerals to objects or events according to rules and it is also one of the basic science skills. [1] We can use both standard and nonstandard measures and estimates to describe the dimensions of an object or event.

There is the strong evidence for using informal approach to measure some properties in spite of the formal tool is available. Measuring with special devices usually hides the principle of measuring and the essence of measured properties.

2. Classification of scales of measurement

The measurement exists in various forms and the scales of measurement fall into certain definite classes. These classes are determined by both the empirical operations invoked in the process of "measuring" and the formal (mathematical) properties of the scales. The statistical manipulations that can legitimately be applied to empirical data depend upon the type of scale against which the data are ordered.

The type of scale achieved depends upon the character of the basic empirical operations performed. These operations are limited ordinarily by the nature of the thing being scaled and by our choice of procedures. [1]

2.1 Nominal scales

The nominal scales are connected with the process of an item distribution into categories

although the classification is usually named as a separated science process skill. The counting concerns the number of categories or the number of items in a group (category) and finally the numerals can be used as names for classes (numerals without a number meaning). The last example also represents an assignment of numerals “according to a rule” as it was mentioned in the definition of the nominal scale.

Scale	Basic empirical operation
Nominal	Determination of equality
Ordinal	Determination of greater or less
Interval	Determination of equality of intervals or differences
Ratio	Determination of equality of ratios

Table 1. *The types of scales [1]*

2.2 Ordinal scales

The ordinal scale arises from the operation of rank-ordering. We cannot say that the differences between following items in rank are equal. It does not make sense to count the average or apply even a simple mathematic operation.

A classic example of an ordinal scale is the scale of hardness of minerals.

2.3 Interval scales

Interval scales have all the characteristics of nominal and ordinal scales, especially the characteristics of the order. In contrast to the lower level measurements, the interval scaling allows determining not only the order of objects according to certain criteria, but also the size of the difference between the measured objects. Interval measurement therefore allows determining how much a certain property of an object is higher or lower than of another object. In other words numerically equal distances on interval scales represent equal distances in the property being measured. Intervals can be added and subtracted, but not multiplied and divided.

2.4 Ratio scales

Ratio scales are the most commonly encountered in physics and are possible only when there exist operations for determining all four relations: equality, rank-order, equality of intervals, and equality of ratios. Once such a scale is set up, its numerical values can be transformed (like from feet to meters) only by multiplying each value by

a constant. An absolute zero is always implied, even though the zero value on some scales may never be produced. All types of statistical measures are applicable to ratio scales. Foremost among the ratio scales is the scale of number itself - cardinal number - the scale we use when we count such things as eggs, pennies, and apples. This scale of the numerosity of aggregates is so basic and so common that it is ordinarily not even mentioned in discussions of measurement. It is conventional to distinguish between two types of ratio scales: fundamental and derived. Fundamental scales are represented by length, weight, whereas derived scales are represented by density, force, and so on. [1]

3. Design of measurements in IBSE

3.1 Example 1

As a first example of the development of a measurement we describe the activity with mineral waters. Pupils should carry out a sensory analysis, more precisely the ordinal sensory test with samples of different mineral waters. The ordinal test is based on ordering the samples according to increasing or decreasing intensity of observed qualitative property. The property that should be monitored in this case is the intensity of the salty taste. The aim is to estimate the order of water samples by the dissolved minerals.

In this case it is used ordinal scaling that belongs to the low forms of measurement. The assessment is carried out through determination of greater or less or the same. There is not defined the unit of measurement and also there are not defined differences between samples (objects). The results of this measurement cannot be handled by adding and subtracting, multiplying and dividing, as the absolute values and the differences are not known.

The ordinal sensory test disadvantage lies in impossibility of reliable evaluation. It is not possible to estimate differences between two samples - if the quality of a balanced group of samples is followed by a group of very variable quality.

Subsequently, the measurement of the mineral content amount can be done by weighting a residue. Weighting the residue belongs to the higher forms of measurement - ratio scaling, which is the absolute scale. The term “absolute” scale arises from the fact that these scales have the absolute zero and therefore allow you to make the comparison of ratios. The measured

values express the intensity of measured properties. Usually, the numeric values are presented as the natural numbers from zero to N. This measurement allows the consistent use of all properties of real numbers, not only adding and subtracting, but also multiplying and dividing.

Sample	A	B	C	D
Weight of the dish				
Weight of the dish and the evaporation residue				
Weight of the evaporation residue				

Table 2. Determining the amount of minerals in the water sample

Sample	Results of the ordinal sensory test	Amount of minerals in 100 ml of the mineral water detected by weighing the residue
A		
B		
C		
D		

Table 3. Comparison of the results acquired by different types (levels) of measurement

The ratio scale (weighting) allows us to recount the mineral content into different volumes of the mineral water. Otherwise, the results acquired by the ordinal sensory test do not depend on the amount of the mineral water.

3.2 Example 2

The following example of the research activity uses several methods of scientific work, but we want to present the other possible way of measuring. The task of pupils is to learn about the concept of the wind erosion and about the one of methods for detecting of dust particles in the air.

The method is based on gravitational sedimentation of the dust particles on an adhesive surface in a time period. The detection of the amount could be done by weighting of the mass increase, but the use of a standard scale

(spectrum) for comparison with sample is more appropriate and simple.

Topic can be set by information that the wind causes a takeaway soil particles and their deposition on the other place. This process is called wind erosion. Dust particles in the air can sediment on various objects. Before they sediment, we can breathe them. The increased content of dust particles in the air is detrimental for us. Pupils receive the task to propose how the presence of dust particles in the air could be detected and how it could be measured. They should also consider in which areas the increased dustiness could be expected and which could not. In this case pupils usually suggest using a sticky surface (usually tape), but also vacuuming dust like a vacuum cleaner. Schools usually do not possess scales (the device for measuring the weight) with required range and reliability so we prefer using some standard scale (spectrum) for detection of dustiness.

The principle of method is collecting dust on the sticky surface. We can prepare the tools by application of the Vaseline layer on a white surface that does not absorb water (Figure 1.).



Figure 1. The tool with adhesive surface

Determination of dust fallout would be carried out after a time period by comparing the intensity of Vaseline pollution with the standard scale (Figure 2.) that visually expresses the surface covered by particles in percentage.

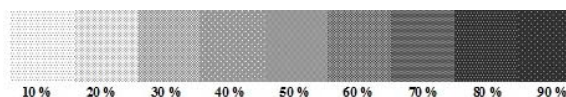

Figure 2. Standard scale for the measurement of the area surface covered by the dust particles

Similar scales can be applied for detection of the water turbidity or the smoke saturation, etc. This measurement belongs to the interval level scaling. It means that the values set in individual

cases are comparable although certain limitations can occur. It is possible to determine how much the results vary, but the absolute value is unknown. Determination of dust in a single location does not make sense. The usage of this method is appropriate to compare the amount of dust particles in several locations or to compare result from one place with some outstanding criterion.

3.3 Direct and indirect measurement

Some properties can be measured directly. This means that there is a reliable tool to detect the size of property and the dimension it used to be expressed in. The properties that could be detected by direct measurement are for example the length (distance) or volume, assuming that we have a ruler (meter) or measuring beaker of the required reliability and range.

On the other hand the indirect measurement uses relations between two variables. It means that the property of our interest is not measured directly, but we measure its impact on the other related variable.

An example would be to determine the concentration of the solution using the colour standards (Figure 3.). Pupils are comparing samples with unknown concentrations with colorimetric standards (samples with known concentrations and different colour saturation). The result is approximate indication of solution concentration.

After detection of concentrations pupils should propose a modification of solution (for example dilution) so it can be used for certain purpose (for example a treatment of the vine by the blue solution of copper sulphate/bluestone). The concentration of the solution is not determined directly, but through the colour intensity of the solution. The more concentrated solution the colour saturation is stronger.

3.4 Reliability of measurement

The measurement accuracy is very important for reliable data comparability. An accent on this aspect of scientific work should be intensified in the process of inquiry-based science education.

Pupils will find out the importance of accuracy and reliability of measurements when they have to propose and prepare their own usable range as the standard of measurement. At first moment they must consider the range necessary for measurement and afterwards the scale precision.

After becoming familiar with colorimetric standards, the teacher can specify a task to determine whether a sample of lemonade they received from the teacher is prepared correctly (as recommended on the package) without tasting it. If it is not prepared correctly, they should modify the sample (by the addition of water or syrup) to match the recommendation on the package. Pupils have to create a range of solutions with known ratio of ingredients (syrup and water, and so prepare a tool for assessment the ratio of these components in the sample. When pupils prepare the scale they have to take in account a few conditions that may limit the accuracy of such measurements. For example, it should be considered that comparisons have to be done in the same containers (tubes) and the assessment of colours requires white background and adequate light.

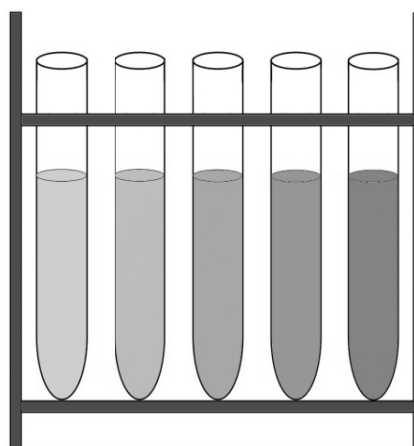

Figure 3. Colorimetric standards

4. Conclusions

Data-gathering or collecting data is the most essential step in scientific method. It involves the processes of measurement, classifying, comparing, estimating and other steps of doing an experiment.

Even though one of the prerequisites of inquiry-based science classes is acquiring measuring skills, there is not enough emphasis in the schools today on developing these skills. [2]

The child could understand the principles of measurement; it already matured to the point of preserving properties of objects. Piaget provided the following stages in accordance to the capability to perceive the preservation of these object properties:

- Constancy of length - about 8 years old,

- Constancy of surface - conceptually about 8 years old, the child is able to calculate the surface in 11 years,
- Constancy of weight - about 10 years old
- Constancy of volume - conceptually around 11 years old, able to calculate the volume to an average of 15 years. [3]

Length, surface, weight and volume are the basic concepts of measurement and they are very difficult for a child. Therefore, the development of measurement skills begins with measuring of the length. It continues with measuring of surface, afterwards measuring of weight and volume of objects.

We presented some examples of various levels of measuring used by children in inquiry-based process of science learning. The mostly used scales are of the lower level and the dimensions are prevailing informal.

The imperfect scale and improvised device used for measurement surprisingly leads to better understanding of measuring principles.

The process of measuring entails determining the quality and quantity to be measured, the selection of an appropriate measuring tool and measuring unit, the calculation of the margin of error that must be considered in the measurement and the decision on the accuracy and consistency of the measurement. [2]

Maturing to this level of measuring skills depends on amount of experience with basic principles of measurement and on the qualified tutoring by the teacher.

5. Acknowledgement

The contribution was prepared and published with financial support of European Commission and the project Pri-Sci-Net.



6. References

- [1] Stevens SS. On the Theory of Scales of Measurement. In Science, New Series, Vol. 103, No. 2684 (Jun. 7, 1946), pp. 677-680.
- [2] Maral S, Oğuz-Ünver A, Yürümezoğlu K. An Activity-Based Study on Providing Basic Knowledge and Skills of Measurement in Teaching. In: Educational

Sciences: Theory & Practice 2012; 11(4): 558-563.

- [3] Wolfinger D. Science in the elementary and middle school. Addison Wesley Longman, 2000, 473 p. ISBN 0-80-13-2058-5.



LEARNING MATERIALS SCIENCE AND TECHNOLOGY FROM HANDS-ON ACTIVITIES

Carmen. Pérez¹, Antonio Collazo¹
Benito.V. Dorrió²

¹Materials Engineering, Applied Mechanics and Construction Department, Univ. of Vigo, Spain

²Applied Physics Department, Univ. of Vigo, Spain

cperez@uvigo.es, acollazo@uvigo.es,
bvazquez@uvigo.es

Abstract. *The present work is a proposal of different hands-on activities to develop in the Materials Science and Technology subject. This is a graduate course given in the Higher School of Mining Engineering and in the School of Industrial Engineering, belonging to the University of Vigo (Spain).*

Hands-on experiments play an important role for the student's learning; those facilitate the development of students' knowledge and skills in more active way than the "magisterial" learning methods.

In this context, the present work shows ten examples of hands-on-activities, which covers most aspects of materials science topics.

Keywords. Hand-on activities, Materials Science and Technology.

1. Introduction

The subject of Materials Science and Technology is currently teaching in the second year of the undergraduate classes of the School of Mining Engineering and School of Industrial Engineering, University of Vigo. The duration is 52 hours, divided in 32 hours of master sessions and 20 hours of laboratory practices and seminars. The objective is to prepare professionals who face the challenge of design and study new materials, using material

resources in a more efficiently way.

Besides the textbooks, the students have supplementary material available on the specific website [1], which facilitates the tracking of the hand-on activities.

During the seminar class, students have to present small projects using the concepts learned during the master classes; this practice allows them to acquire communication skills. The evaluation seeks to be formative, informing students of their mistakes and what is important.

In this context, the present work proposes the introduction of a set demonstration activities in the master class that raise the student's curiosity while increasing interest in the theoretical concepts.

2. A selection of hand-on activities

Many resources can be employed to create learning situations that promoted a more fruitful relationship between teachers and students [2-5]. The set of manipulative activities presented below encourage and reinforce learning specific skills and knowledge of the subject, illustrating various concepts which by their level of abstraction may be more difficult to assimilate by students. Those are useful also to visualize the contents in a more practical way, offering an exciting alternative to the traditional master session. Many of these manipulative activities can be supplemented with online simulation resources [6-9].

2.1. Activity I. A shot model to illustrate crystal defects.

The crystal structure is not perfect; the structure contains defects such as vacancies, dislocations or grain boundaries. Crystal defects are important in determining many material properties, such as the rate of atomic diffusion and mechanical strength [4].

We can use a "shot model" to get a picture of crystal defects. The model consists of many small ball bearings confined between two transparent glass sheets. They tend to behave like the atoms in a crystal, and can show the defects explained above. Tapping of the model causes rearrangements of the balls, which is analogous to thermal activation. The result is the grain growth, due to the atomic diffusion process within the solid.

2.2. Activity II. Macroscopic observation of crystalline solids.

An easy way to illustrate the concept of crystal structure is the observation of solids with different type of crystalline structure. Some examples are shown in Fig. 2, which allows the explanation of the crystallization process. The differences between single crystal, polycrystalline materials and non-crystalline materials will be introduced.

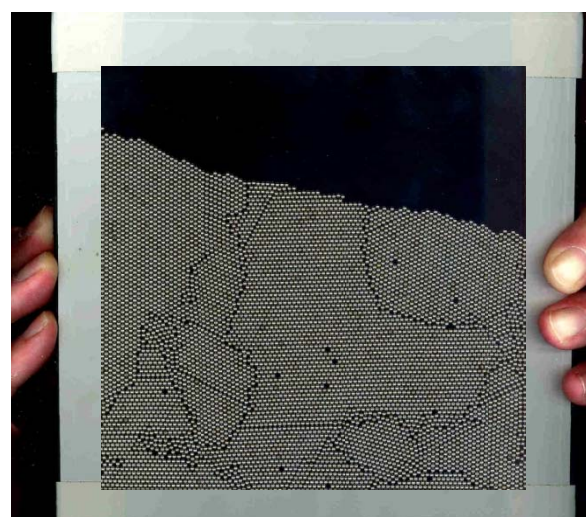
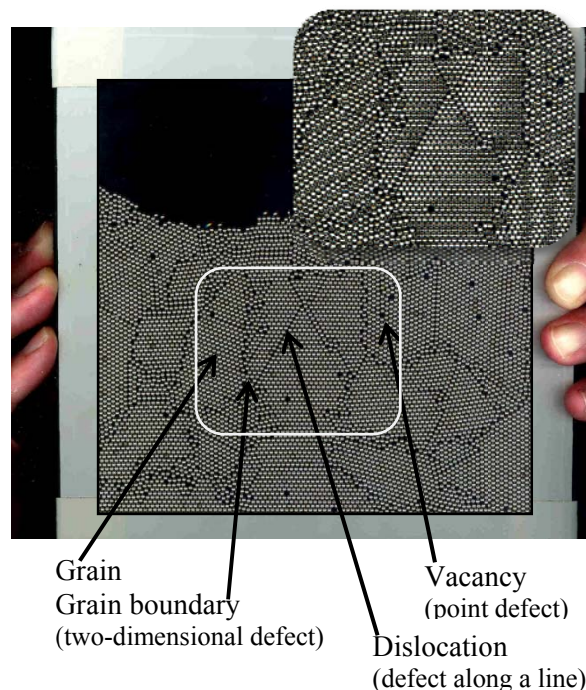

Figure 1. Shot model to illustrate the crystal defects (up) and grain growth after tapping the model, simulating energy activation (down)

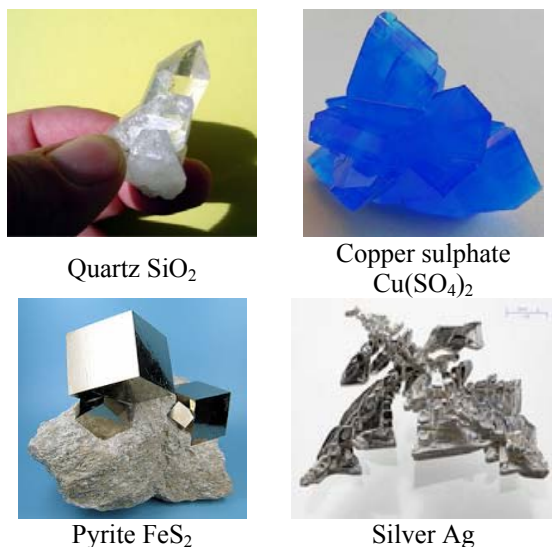

Figure 2. Examples of different types of crystals to illustrate the concept of crystallization.

2.3. Activity III. The tin cry and the strengthening mechanisms.

“Tin cry” is the characteristic sound that is made when a bar of tin metal is bent. The sound is caused by the shearing of the crystals in the metal [10]. This phenomenon is typical of metals which undergo deformation by twinning (low crystallographic symmetry). During the twin nucleation and growth, acoustic waves are generated.

This activity allows the introduction of the strengthening mechanisms in metals, in a pleasant way [11].

2.4. Activity IV. Fracture Mechanics.

Principles of fracture mechanics can be illustrated by the crack growth in inflated balloons [3].

First, pieces of tape with different orientations will stick to inflated balloons (Fig. 4a). What will happen when you puncture them with a pin? The answer depends on these orientations. Students will find that the crack propagation is faster when the tape is placed in the perpendicular direction (Fig. 4b and 4c).

This activity can be related to the structural stability of a cylindrical pressure vessel and the crack propagation. As a complementary tool, the students will access to the CES Edupack™ software, developed by the University of Cambridge. It consists in teaching resource for materials in engineering, science, processing, and design [12], Fig. 5 display an example how to

use it:

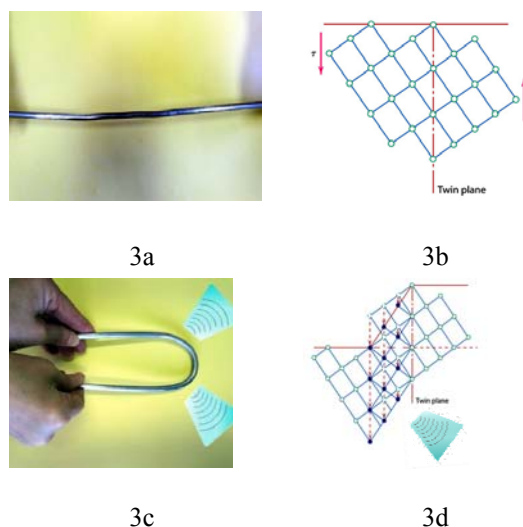

Figure 3. The tin cry activity. A bar of tin (3a) represents a perfect crystal (3b). When it is blended a characteristic sound is heard (3c), consequence of twinning (3d)

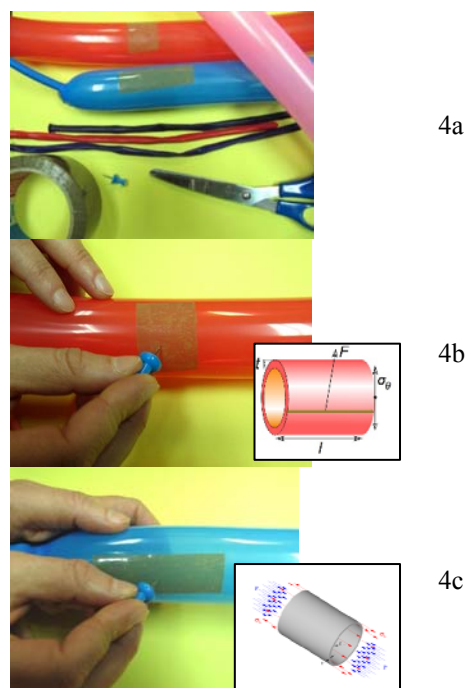

Figure 4. Illustration of the basics Fracture Mechanics.

2.5. Activity V. Smart materials: shape memory alloys (SMA).

Certain alloys exhibit the “memory effect”, which consists in the ability to undergo plastic deformation and then recovering its original shape upon heating. Nowadays, represent an promising alternative to the traditional alloys in fields like as medicine and aerospace [13].

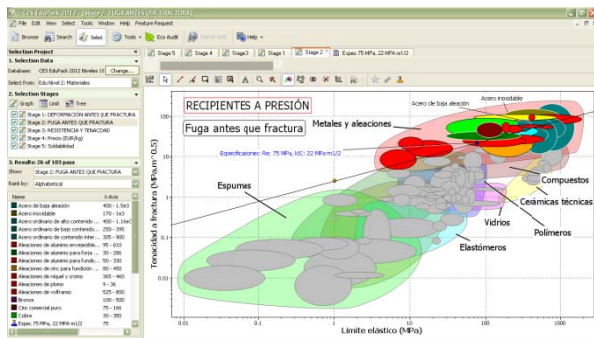

Figure 5. Example of using CES Edupack™ software.

To illustrate that phenomenon we will use nitinol (metal alloy of nickel and titanium). The activity consists of plastically deforming a piece of nitinol with defined shape (in our case the word “HOT”) (Fig. 6b) into an arbitrary shape, then using a hair-dryer to heat it up sufficiently to stimulate phase transformations, the original word will be recovered (Fig. 6c).

This effect is based on solid phase changes. At lower temperatures exists the martensite structure, the alloy can easily be deformed into any shape. When the alloy is heated, it undergoes a transformation from martensite to austenite. In the austenite phase, the material recovers the shape it had before it was deformed (Fig. 6c).

2.6. Activity VI. Relationship between structure-performance-processing.

The most fascinating aspect of materials science involves the investigation of materials structure to control their properties through synthesis and processing [15]. To illustrate this relationship we propose two activities based on the chemical behaviour of polymers.

2.6.1. Chemical behaviour - structure correlation.

The activity consists in the evaluation of the rate of dissolution of two non-polar polymers foams, polypropylene (PP) and polystyrene (PS) in acetone (non-polar solvent). The students will observe the faster dissolution of PS. Although the chemical composition is similar for both plastics, the crystalline character of PP makes that it is more chemical resistant than amorphous materials, like as PS [16].

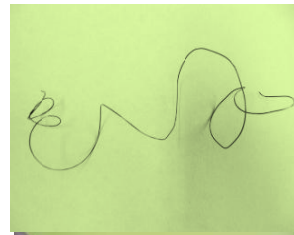

6a



6b

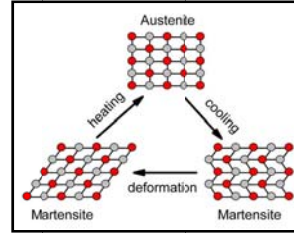

6c

Figure 6. The shape memory activity (6a and 6b) [14] and drawing of crystal phase transformation (6c).



Figure 7. Example for illustrating the different chemical reactivity depending on the structure. The polypropylene foam (white) dissolves slower than the polystyrene foam (green) in acetone [17].

2.6.2. Chemical resistance - processing correlation.

The material’s properties depend on its structure and this is a function of how it is processed. To better understand that concept it can design the activity displayed in Fig. 8. We use a transparent petri dish (Fig. 8a), which is obtained by injection molding, the most widely used technique for obtained thermoplastic products. The weakest part of the pieces obtained by this

process is the “injection point”, we can visualize the internal stress located at that point using an overhead projector and place the petri dish between polarizing sheets (Fig. 8b). After submitting the piece to an aggressive environment, we can observe an intense attack, starting in the injection point and following the stress lines (Fig. 8c).

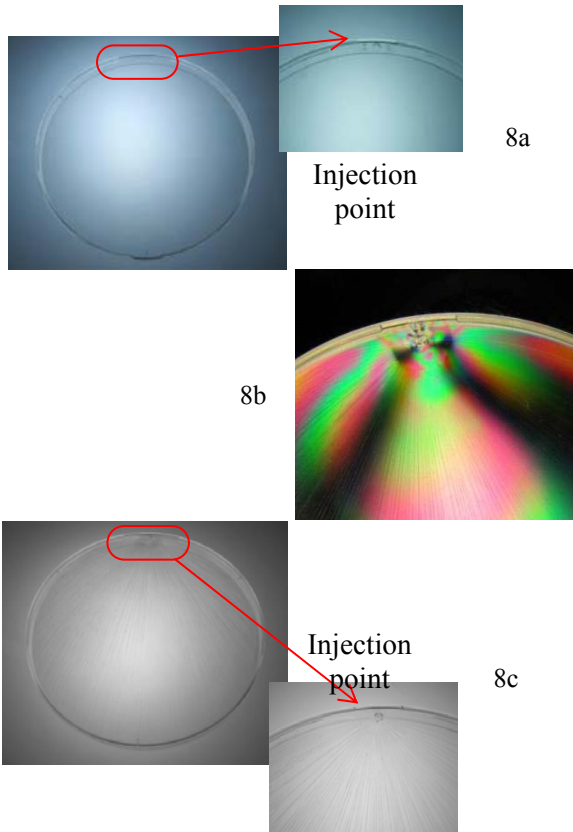

Figure 8. Activity that shows the relationship between processing and chemical performance.

2.7. Activity VII. Magnetic properties: levitation.

“Magnetic levitation” consists in an object suspension with no support other than magnetic fields. It is a very amazing property of diamagnetic materials [18]. To cause diamagnetic levitation, both the diamagnetic material and magnetic material must produce a combined repulsive force to overcome the force of gravity [19].

The proposed demonstration uses a thin piece of pyrolytic graphite, which is placed over a strong rare-earth magnet. The pyrolytic graphite is levitated above the magnet (Fig. 9).

On the other side, we can find the ferromagnetic materials, such as iron, which can form permanent magnets. One application with high

industrial impact is the “magnetic particle inspection (MPI)”, which is a non-destructive test method for the detection of surface and sub-surface discontinuities in ferrous materials. The students will have the opportunity to perform this test in the laboratory class (Fig. 10) [20].

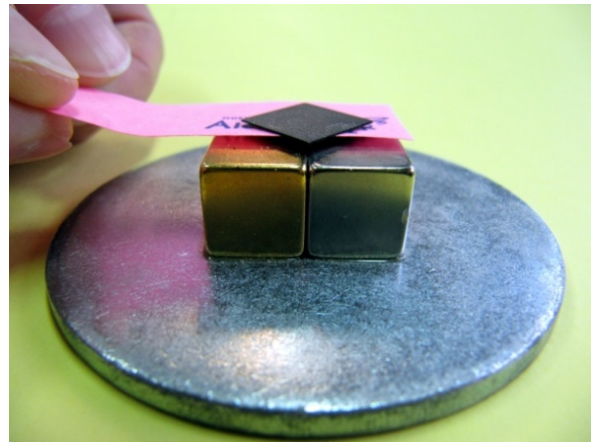

Figure 9. Levitating pyrolytic carbon



Figure 10. Equipment necessary to illustrate the magnetic particle inspection

3. Conclusions

The adaptation of the European Higher Education Area (EHEA) require new teaching methodologies, which facilitate a better comprehension of some aspects that, for their abstraction, could be more difficult for the students. This aspect is especially important for scientific-technological subjects.

Following this line, the present work proposes a set of seven hand-on activities that aim to strengthen the contents introduced during the master classes. These activities are design for Materials Science and Technology field, specifically for the undergraduate students of Higher School of Mining Engineering and

School of Industrial Engineering, belonging to the University of Vigo (Spain). Nevertheless, the methodology can be extrapolated to other disciplines.

4. References

- [1] Servizo de Teledocencia-FAITIC, Universidade de Vigo, 2008. <http://faitic.uvigo.es/>
- [2] Classroom Demonstrations and Laboratory Experiments. http://www.d.umn.edu/~ssternbe/Courses/materials/Demos_Expts_6E.pdf
- [3] Gleixner SH. Formas en las que los ingenieros puedan involucrarse en el reclutamiento de futuros científicos e ingenieros en materiales. *Journal of Materials Education* 2001; 23: 39-45
- [4] University of Cambridge. Dissemination of IT for the Promotion of Materials Science (DoITPoMS). Creative Commons Attribution-NonCommercial-ShareAlike 2.0 UK: England & Wales License; 2004 <http://www.doitpoms.ac.uk/>
- [5] Pérez-Pérez C, Collazo-Fernández A, Dorrio BV. High-Technology Materials for Hands-on Activities in classroom. In: Divjak S, editor. *Proceedings of the International Conference on Hands on Science; 2011 Sep 15-17; Ljubljana, Slovenia*. Ljubljana: University of Ljubljana; 2011. p. 101-106.
- [6] University of Liverpool: Matter for Universities, 2000 <http://www.matter.org.uk/universities.htm>
- [7] Portland State's Nano-Crystallography Group (University of Portland State): "interactive 3D visualizations of crystal structures and morphologies", 2008 <http://nanocrystallography.research.pdx.edu/home/>
- [8] Imaging Technology Group (NASA's Kennedy Space Center and Learning Technologies): The Virtual Microscope, 2007. <http://virtual.itg.uiuc.edu/>
- [9] Ainissa G. Ramirez: Demoworks: The fine art of materials science demonstrations, 2004. http://www.strangematterexhibit.com/demoworks_final.pdf
- [10] http://www.youtube.com/watch?feature=player_detailpage&v=kzIsvbKHgfU; 2011
- [11] Callister WD, Rethwisch DG. *Materials Science and Engineering*. New York, Wiley & Sons; 2011
- [12] CES EduPack software, Granta Design Limited, Cambridge, UK, 2009. www.grantadesign.com/education
- [13] Richard Lin. *Shape Memory Alloys and Their Applications*. <http://www.stanford.edu/~richlin1/sma/sma.html>
- [14] Fotos y videos\MVI_1861.MOV
- [15] Askeland DR, Fulay PP, Wright WJ. *The Science and Engineering of Materials*. Stamford, Cengage Learning; 2011
- [16] Chanda M, Roy SK. *Plastics Technology Handbook*. New York, Marcel Dekker, Inc.; 1987
- [17] Fotos y videos\MVI_1872.MOV
- [18] <http://www.youtube.com/watch?v=nWTSzBWEsms>; 2006
- [19] <http://www.rare-earth-magnets.com/t-magnetic-levitation.aspx>
- [20] The American Society for Non Destructive Testing, <https://www.asnt.org/>



INVESTIGATE THE SHADOWS OF OBJECTS: A PEDAGOGICAL INTERVENTION PROJECT WITH PRIMARY SCHOOL CHILDREN

Silvana Novera¹, Cátia Abreu¹,
Paulo Varela², Manuel Filipe Costa³

¹Preschool teachers

²Institute of Education

³School of Sciences

University of Minho, Portugal,

pibvarela@ie.uminho.pt

mfcosta@fisica.uminho.pt

Abstract. *This poster results from a pedagogical intervention project, carried out at a primary school in the district of Braga - Portugal. The intervention took place in a class of the 3rd year, composed of 16 students, and it incorporated the practice of inquiry-based science teaching addressing the theme "Light Experiments", which is part of the "Environmental Studies" curricular area. Various class activities were planned and implemented concerning some of the factors that influence the shadow of an object, in order to*

find answers to the following questions: a) Will 3rd year students, aged 7/8 years, be able to construct and execute an investigation strategy that involves manipulating and controlling variables? b) What are the main difficulties experienced by students in the designing and execution of such a strategy? c) How will students, in interaction with the teacher and with their peers, gradually design and execute their investigation strategy in order to respond to the problem formulated? The project adopted an action research methodology. A careful record was kept of the events most relevant to the questions under study in each class. This data was used to prepare the class diaries - descriptive and reflective narratives prepared based on recorded audio and field notes made during participant observation in the context of the classroom. A content analysis of the diaries has identified a few elements that provide answers to the research questions posed above. The results obtained from the learning assessment test are also presented.

Keywords: Collaborative and Reflexive Learning, Inquiry-Based Science Education.

1. Introduction

In science teaching, one of the approaches that have been suggested by the science curricula of many countries and by some international organizations is inquiry-based science teaching. Inquiry teaching is the “intentional process of diagnosing problems, critiquing experiments and distinguishing alternatives, planning investigations, researching conjectures, searching for information, constructing models, debating with peers, and forming coherent arguments” [1, p. 4]. The National Research Council [2] identifies five attributes that learners will acquire from inquiry-based science teaching: a) engaging in scientifically oriented questions; b) giving priority to evidence in answering questions; c) formulating explanations based on evidence; d) connecting explanations to scientific knowledge, and e) communicating and justifying explanations. According to Drayton and Falk [3, p. 25], “The inquiry-based approach to science education [...] introduces students to science contents, including the process of investigation, in a context of reasoning, which gives science its dynamic nature and provides the logical framework that enables the understanding of scientific innovation and the evaluation of

scientific claims. Inquiry is not process versus content; it is rather a way of learning content”. Inquiry teaching is an approach that enables the learning of concepts and the development of scientific processes [3]. Scientific inquiry encourages the development of problem solving, communication and thinking skills, as students pose questions about the natural world and then seek evidence to answer their questions [3]. The ability to question, hypothesize, design investigations and develop conclusions based on evidence gives all students the problem-solving, communication, and thinking skills they will need to claim their place in the 21st century world [2]. In this sense, one skill that all students should acquire is the ability to conduct an investigation where they keep everything else constant while changing one single variable. This ability provides a powerful general strategy for solving many problems encountered in the workplace and in everyday life [2, pp. 14-15]

However, in the majority of European countries, the reality of classroom practice is that these methods are being implemented by relatively few teachers [3] [4]. Reports from the European Commission continue to advocate the advantages of inquiry-based science education and its recommendations clearly promote the use of inquiry-based science teaching in Europe [5].

In Portugal, the situation is no different. Although the science curriculum of primary education suggests a teaching practice in which students should be “active observers, with the ability to discover, investigate, experiment and learn” [3, p. 102], this teaching practice is still only occasional, with only a residual expression in the teachers' pedagogical practices [4]. In light of this, the present study was conducted - a pedagogical intervention project in the field of science teaching, aimed at promoting an approach to science education based on an active and constructive role for the student, in a context of social interaction with peers and with the teacher [5] [6].

2. Objectives

The project for a pedagogical intervention in science teaching incorporates a practice of inquiry-based science teaching, addressing the theme “Light Experiments”, part of the “Environmental Studies” curricular area of primary education. Various class activities were planned and implemented around some of the factors that influence the shadow of an object, in

order to find answers to the following questions: a) Will 3rd year students, aged 7/8 years, be able to construct and execute an investigation strategy that involves manipulating and controlling variables? b) What are the main difficulties experienced by students in the designing and execution of such a strategy? c) How will students, in interaction with the teacher and with their peers, gradually design and execute their investigation strategy in order to respond to the problem formulated?

3. Methods

The study adopted an action research approach. A pedagogical intervention in sciences was carried out with a class of the 3rd year, at a school located on the outskirts of the city of Braga - Portugal. The class was composed of 16 students, 10 boys and 6 girls, aged 7 to 8 years. For two months, 7 lessons were taught on the curricular topic "Light Experiments", amounting to a total of 15 hours of intervention in the classroom.

For each topic addressed, a teaching and learning plan was prepared, containing the following elements: i) learning goals; ii) materials needed for the groups to implement the planned activities; iii) guidelines for the teaching and learning process, and iv) a record sheet for each student. Each lesson, which corresponds to an action research cycle, begins with a teaching and learning plan that is implemented flexibly, according to the teaching and learning processes generated and promoted in the class reality. The classes were taught by the two authors of this poster, who, in collaboration with the class teacher, played the role both of researchers and teachers.

The data generated in the intervention was collected using two complementary methods, which were the field notes made by the researchers and the audio recordings of the lessons. This raw data was later compiled in the form of detailed narratives of the most relevant events that took place in the classroom – the class diaries. These constituted the principal method of recording data and, simultaneously, a strategy for reflection and for the modelling of the teaching and learning process [7] [8]. Additionally, tests were conducted to evaluate the learning acquired by the students and a questionnaire was proposed to parents/guardians, aiming to collect comments and reactions expressed by the students in the family context,

concerning the nature of the intervention carried out in class.

4. Some results

The data obtained from the various collection methods used is still in the process of treatment and analysis. However, through the interpretive content analysis on one of the class of diaries, it is possible to describe and illustrate how students, in interaction with the teacher and their peers, gradually design and execute each of the investigations conducted in the classroom.

Interpretive content analysis of the class diary

The class begins with the following question:

A. Does the distance between the light source (flashlight) and an object have an influence on the length of the shadow of that object?

The groups make predictions.

There are different predictions around the class:

- one that supports the idea that, as the distance between the object and the light source (flashlight) decreases, so will the size of the object's shadow. Examples: *we think that, if the object is closer to the light, its shadow gets smaller, because the light is closer (Daniela); I think that if we move the flashlight away, the shadow will be bigger and if we move it closer, the shadow will be smaller (Bárbara).*
- another that supports the idea that, as the distance between the object and the light source (flashlight) decreases, the shadow of the object gets larger. Examples: *I think that, as we move the flashlight closer, the shadow gets bigger, but if we move it farther away, it gets smaller (Diogo). (...)Very close to the flashlight, the object gets smaller and farther away like this; it gets bigger (Bruna).*

B. What do we need to do to find out if the distance between the flashlight and the object influences the length of the shadow?

They build an investigation plan.

Encouraged by the teacher's reflective questioning and interacting with their colleagues, the students mentally design a research plan, which will be implemented within each group.

The plan includes the following elements:

B₁ – The independent variable.

Spontaneously, the students' thoughts begin focusing on the distance between the flashlight and the object. Some of them suggest operational procedures. Examples:

We could pick up an object and then move the flashlight closer and further away, to see if the shadow is the same or is different (Joel). We have to place the flashlight first close to the object, then at an intermediate distance and then far away from the object (Eva). We have to place the object at different distances, to find out more things (Bruna).

B₂ – They operationalized the independent variable.

Will it be enough if we use only two distances?

The students suggest using three different distances between the flashlight and the object. Examples:

(...) the first distance can be 10 cm (Joel); the second can be 20 cm (Leonardo); and the last can be 30 cm (Eva); that is too much (Ângelo); we'll make 5 cm differences, then (Eva); 10 cm, 15 cm and 20 cm (Lara). The class agrees with the three distances suggested by Lara. And how are we going to measure those distances? With the ruler (several).

B₃ - They identify and operationalize the dependent variable.

And then, what do we have to measure to know if the shadow depends on the distance between the object and the flashlight? The length of the shadow (Francisca). And how do we measure the length of the shadows? With the ruler (several children). And where will we cast the object's shadow? On a sheet of cardstock, say Eva and Bruna. Where will we put it? Bárbara suggests placing the cardstock vertically, propped up between two tables. Where will we record the measurements we take? On a table, as we did in the other research project (Leonardo and Lara).

B₄ - They identify and operationalize the controllable variables.

- The object to be used for the investigation - *How should the object be, for our investigation? I think it has to be always the same (Daniela); the object has to be always the same, otherwise, we will not know (Angelo); if we use different objects, they will cast different shadows (Joel);* When

asked why the objects have to be the same size, some children state: *because the shadow has to do with the size of the object (Joel); if an object is larger than another, the shadow can be bigger or smaller (Daniela);*

- The flashlight and the positioning of the light beam - *How should the flashlight be? It must always be the same (Lara). And how should we place it? On the table, in front of the target-cardstock (Leonardo). How far away from the cardstock should we put the flashlight? - The teacher asks. Several children say "30 cm", but Joel thinks it is better to place it "40 or 50 cm away, so we can see the shadow better". The groups agree that the distance between the flashlight and the cardstock will be 40 cm. The different distances between the flashlight and the object - an eraser - will be 10 cm, 15 cm and 20 cm. The students also decide that the flashlight must remain fixed, always in the same place, and it should be the object that moves to the different positions.*

C. They execute the investigation plan within each group.

After mentally constructing and clarifying the set of actions to perform, the students execute the plan within each group. The groups are provided with the necessary equipment: identical flashlights; equal erasers – the object to place at different distances of the flashlight; a 40 cm x 40 cm cardstock target; a ruler and the individual record sheet. As they encounter difficulties, the groups are encouraged and helped by the teacher. The greatest difficulty felt by the children was the marking of the different distances between the flashlight and the object - the eraser.

D. They record the results obtained in each group.

The groups record, and report to the class, the length of the shadow of the object, at each of the three considered distances between the object and the flashlight.

E. They draw conclusions from the data obtained

The students' attention is focused on the average length of the shadows, obtained at each of the distances considered, and they are encouraged to draw their conclusions.

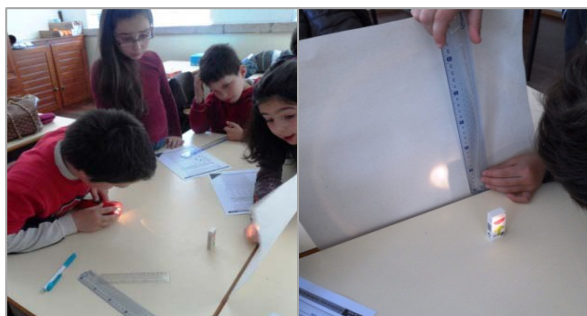

Figure 1. The students execute the investigation.

Distance between the light source and the object (cm)	Length of the shadow of the object by group (cm)			
	Group 1	Group 2	Group 3	Average
10	16	15	16	15.7
15	13	12	12	12.3
20	10	10	10	10

Table 1. Results records.

Why are there differences in the length of the shadows of the objects? - I ask. The children express their ideas: *I have concluded that when we move the object away from the light source, the shadow will get smaller (Eva); the shadow decreases when the object is moved away from the flashlight (Lara); and when we move it closer, the shadow gets bigger (Bruna); when we move the object farther away, the shadow gets smaller... the smaller the shadow (Daniela); in*

the beginning, we were saying it was the opposite (Joel); that was what I said (Guilherme); we should never take something as certain (Joel); the smaller the distance between the object and the flashlight, the greater the length of the shadow and, the greater the distance, the smaller the shadow (Francisca); if the distance was 25 cm, the shadow would be smaller (Daniela); because, as the distance increases, the shadow decreases (Francisca); ... it gets smaller (Joel).

F. They collectively construct the research report

At the end of the class, the students collectively construct the research report.

The final narrative, resulting from the various interventions by the children, is as follows:

We begin by reflecting on the following: does the distance between the object and the light source (flashlight) have an effect on the length of the shadow?

All groups said it does, but their explanations were not the same. Some thought that when the object moved away from the flashlight, the shadow grew larger and when it moved closer to the flashlight, the shadow grew smaller. Contrarily, others thought that when the object moved closer to the flashlight, the shadow grew larger and when it moved away, the shadow grew smaller.

To find out the answer, we conducted an investigation, using the following materials: a flashlight, an eraser, a ruler and a cardstock sheet. We measured the distance between the cardstock and the flashlight (40 cm) and then we measured three different distances from the flashlight to the eraser (10 cm, 15 cm, 20 cm).

We turned on the flashlight and pointed it at the eraser. We saw the shadow of the eraser on the cardstock and measured its length. We placed the object at a different distance and measured the length of the shadow again. We repeated the experiment, placing the eraser farther away from the light source. We recorded these measurements on a table, calculated the average values and built a graph with the distance from the light source to the object and the length of the shadow.

We have concluded that the further away the object was from the flashlight, the smaller the shadow. And the closer the object was from the flashlight, the larger the shadow.

5. Some final considerations

The data obtained from the various collection methods used is still in the process of treatment and analysis. The results presented above are only a small part of the results obtained in the study. However, they contain some elements that provide answers to the research questions formulated as the goals for this study. They suggest that, in order to plan and implement a research project, children aged 7/8 years require a high level of scaffolding to reduce the difficulty of the task and allow students to gradually build a coherent strategy to provide an answer to the research problem. In this sense, the teacher's role is crucial. Through questioning, which encourages reflection and action in students, the teacher, as is necessary, helps, encourages and regulates the cognitive activity of students. On the other hand, the initial mental planning and clarifying of the research strategy, in a context of large group collaboration, appears to be a fruitful pedagogical strategy and students can subsequently execute it within each group with some autonomy.

6. References

- [1] Linn MC, Davis EA, Bell P. Internet environments for science education, London: Lawrence Erlbaum, 2004
- [2] National Research Council, "Inquiry and the national science education standards: A guide for teaching and learning," National Academy Press, Washington, DC, 2000.
- [3] Drayton B, Falk J. "Tell-tale signs of the inquiry-oriented classroom," NASSP Bulletin, vol. 85, n.º 623, pp. 24-34, 2001
- [4] Harlen W. "Evaluating Inquiry-Based Science Developments.," 11 May 2004. [Online]
- [5] Cuevas P, Lee O, Hart J, Deaktor R, "Improving Science Inquiry with Elementary Students of Diverse Backgrounds," Journal of Research in Science Teaching, vol. 42, n.º 3, pp. 337-357, 2005
- [6] Abd-El-Khalick S, Baujaoude R, Duschl N, Lederman G, Mamlok-Naaman R, Hofstein A. "Inquiry in science education: International perspectives," Science Education, vol. 88, n.º 3, pp. 397-419, 2004
- [7] Kask K, Rannikmäe M. "Towards a model describing student learning related to

inquiry based experimental work linked to everyday situations," Journal of Science Education, vol. 10, n.º 1, pp. 15-19, 2009

- [8] Cavas B, "The meaning of and need for "Inquiry Based Science Education (IBSE)," Journal of Baltic Science Education, vol. 11, n.º 1, pp. 4-6, 2012
- [9] ME, "Organização Curricular e programas Ensino Básico – 1º Ciclo," Ministério da Educação. Departamento de Educação Básica, Mem Martins, 2004
- [10] Sá J. Renovar as Práticas no 1º Ciclo Pela Via das Ciências da Natureza, Porto: Porto Editora, 2002
- [11] Larkin S. "Collaborative Group Work and Individual Development of Metacognition in the Early Years," Research in Science Education, vol. 36, pp. 7-27, 2006
- [12] Harlen W. Enseñanza y aprendizaje de las ciencias. (2ª ed. atualizada), Madrid: Ediciones Morata, 2007
- [13] Sá JG. "Diary Writing: An Interpretative Research Method of Teaching and Learning," Educational Research and Evaluation, vol. 8, n.º 2, pp. 149-168, 2002
- [14] Zabalza MA. Diarios de clase: un instrumento de investigación, Madrid: Narcea, 2004



ANALYSIS OF THE PROCESS OF EXPLORING A PHYSICS ACTIVITY WITH PRE-SCHOOL CHILDREN: THE BALLOON ROCKET

Paulo Varela¹ Rita Pereira²,
Cristina Silva²; Marta Fernandes²,

Manuel Filipe Costa³

¹Institute of Education

²Pre-school Teachers

³School of Sciences

University of Minho, Portugal

pibvarela@ie.uminho.pt

mfcosta@fisica.uminho.pt

Abstract. *This poster analyses the process of exploring a physics activity – the balloon rocket – with children aged 4-5, promoted by a group of pre-school teachers who attended a training course conducted within the European project PriSciNet¹. The analysis of this process is focused on the class diary - a descriptive and reflective narrative prepared by the trainees, based on field notes and audio recordings made during the implementation of the activity with pre-school children. The analysis of the class diary provides an insight on the learning steps attained by the children when exploring the activity. Those learning steps, combined with the individual assessment of each child's drawings and respective comments, shows that they are able to overcome challenges of a complex cognitive nature when these are approached in a collaborative context, of stimulation and freedom to express their thoughts. This analysis further demonstrates that the trainee pre-school teachers accomplished a successful didactical integration of the approach to experimental science recommended for children.*

Keywords. Inquiry-based Science Education; Teacher training

1. Introduction

It is widely accepted that sciences are of great importance for the education and development of

children. The reality in which children live today requires that they grasp scientific knowledge, adopt positive attitudes towards sciences and, especially, acquire thinking skills, in order to become conscious, reflective, participant and critical citizens, aware of the problems of the world around them [1, 2]. This recognition has materialized, both at an international and national level, in the curricula of early school years, which have been attributing a growing importance to sciences and their experimental approach, as a means to promote the students' scientific literacy [3, 4].

In Portugal, Physical and Natural Sciences are included in the area of "Knowledge of the World" of Preschool Education [5] and in the "Environmental Studies" curricular area, included in the program of Primary Education [6]. The "Curricular Guidelines for Pre-school Education" and the program for the Primary Education contain recommendations suggesting that teachers and educators adopt a more practical and experimental approach to sciences. However, according to Sá [7, 8], for many teachers and educators, the real issue is: how is all this actually carried out with children, in the classroom? The insufficient scientific and pedagogical knowledge in the field of sciences generates low self-confidence or a feeling of insecurity and anxiety in teachers and educators, which has led to a reduced expression of this area in their educational action [1, 9, 10, 11].

Therefore, it is essential to provide educators and teachers with training in sciences, which promotes both the acquisition of scientific knowledge and the construction of a specific pedagogical knowledge that allows them to promote a practical and experimental approach, with their students, in the classroom. For this, it is important that they have the tools to support their pedagogical action, namely material resources and planned activities that can function as instruments to support and guide their educational practice.

2. Objectives

According to previous concerns, a science teaching training program was held in Portugal within the European Project PriSciNet for primary school and pre-school teachers. The main goals of the training program were: a) to promote the development of a scientific and didactical approach to experimental science themes for teachers and educators; b)

¹ Project full title: "Networking Primary Science Educators as a means to provide training and professional development in Inquiry Based Teaching" - FP7-SCIENCE-IN-SOCIETY-2010-1.

implementing a set of teaching and learning activities, previously planned in the context of the classroom, employing an approach based on experimentation, sharing and discussion of different points of view about the scientific phenomena under study. Based on the case of the implementation of the activity "the Balloon rocket", this poster intends to describe and analyse the process of exploration promoted, with children aged 4 and 5 years, by a group of Pre-school Teachers who attended a training course carried out within the European Project PriSciNet.

3. Methodology and training contexts

The training process adopted an isomorphic approach, taking on a configuration that is in line with the science exploration perspective recommended for children. According to Sá, "there is no way other to make teachers and educators understand a learning process which they have never experienced themselves other than actually make them go through this process, as apprentices" [8, p. 57]. In this training context, theoretical approaches emerge and develop from concrete practical situations, through: a) the carrying out, by the trainees, of the same activities that are planned for the children, b) the analysis of the class diaries, prepared as part of a process of action research conducted by the first author of this poster during the implementation, in classrooms, of several experimental science activities with the children, c) and the viewing of video recordings of experimental science activities implemented and explored with children in these levels of education. As an integral part of this educational process, in their educational activities with their students, teachers and educators put into practice the knowledge acquired in the training context. For this, experimental science activity plans are supplied, which, in addition to the necessary material and learning objectives, contain directions on how to explore these activities and induce in children an experimenting and investigative attitude towards the proposed learning activities.

In schools and kindergartens, teachers and early childhood educators implement these science activities, according to the science teaching and learning perspective addressed in the previously described training context. During the exploration process, teachers and educators prepare class diaries - descriptive and reflective

narratives prepared based on audio recordings and written records made during the implementation of the activities in the classroom.

4. Activity: "the balloon rocket"

In general, children know that when a balloon is filled with air and then released, in a room, for example, it acquires an irregular trajectory, while it expels the air, eventually ending up stationary on the floor [12]. How do we turn the irregular trajectory of the balloon into a straight-line movement? This question suddenly poses an enigma for the children. Once the meaning of "straight-line movement" is clearly established, it is necessary to help children to think, in order to collectively build a device to give the balloon a straight-line motion. Then the objects are put into evidence, in a specific way and in a sequence that triggers the construction of ideas about functional connections between those objects.

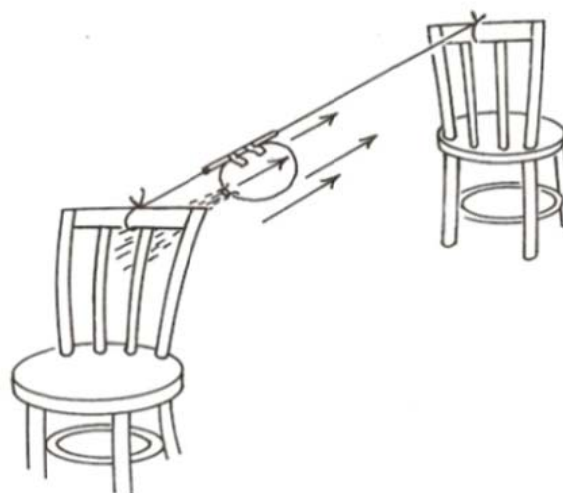

Figure 1. The balloon rocket

The class mentally follows the process of building the device: i) the wire is threaded through the drinking straw ii) the wire is then tied to two chairs, at a sufficient distance from each other; iii) the air-filled balloon is taped to the straw, with the opening facing the nearest chair; iv) the opening of the balloon is released and it will slide along the wire.

5. Results of the analysis of the process of exploring the activity with pre-school children

Based on the analysis of the content of the class diary, prepared by a group of pre-school

teachers, following the implementation of the activity "the balloon rocket", the exploration process that took place in the classroom with pre-school children is described and interpreted. The activity begins with the following question:

a. What will happen if I release this balloon filled with air?

- Children make predictions. Excerpt from the diary:

It will fly (Rodrigo). *It will move* (Sara). *It will get away* (Mariana). When asked why the balloon would "get away", they answer: *because it's full of air* (Sara, 5 years old); *there is air in it* (António).

b. What do we have to do to see if your answers are correct?

- They put their predictions to the test and reflect upon the experimental evidence. Excerpt from the diary:

The children's opinions are consistent in the idea of releasing the balloon: *You have to let go of the balloon* (Several). The balloon is released into the air inside the room. The children are thrilled with what happens. After they calm down, I ask: *what happened to the balloon?* Mariana answers: *it got away. How did the balloon "get away"?* - I ask. Sara, timidly, replies: *it went flying, in curves. [...]* *twirling around* - adds Rodrigo.

c. How do we turn the movement of the balloon into a straight-line trajectory?

- They understand the meaning of straight-line trajectory. Excerpt from the diary:

Initially, the children give thoughtless answers: *You tie a knot on it* (Rodrigo). *If we tied a knot on the balloon, would the air come out?* Children say no, the air would not be able to escape. When questioned on what a straight-line movement is, António, gesturing with his hands, says *it's going straight, like this... always straight ahead*. The others agree with António, showing that they understand the meaning of "straight-line".

- They identify the materials. Excerpt from the diary:

The various materials are presented. The children identify them correctly: *two drinking straws; adhesive tape; balloons; a clothes peg; and scissors*. Only João recognises the wire - *fishing line*.

- They build the "balloon rocket" collectively. Excerpt from the diary:

The children's attention and thoughts are focused on the materials, with a view to give contributions to the collective construction of a device to turn the irregular movement of the balloon into a rectilinear motion - "the balloon rocket". One end of the wire is tied to a chair. Sara threads the wire through a drinking straw. *Now, what should we do with the other end of the wire?* - I ask. *We tie it to that chair* (Sara) After the wire is tied to the chairs, I ask: *how is this going to help us?* After a few moments, António replies: *I think we could put the balloon on the wire like this and then it would go along by itself* (he holds the empty balloon horizontally next to the wire and makes a gesture of the motion the balloon will follow along the wire). The other children disagree with António's idea and say that the balloon will not move by itself: *only if you fill it with air* (Beatriz). I fill the balloon with air and ask: *And now, how do we close the opening of the balloon?* *With the peg* (several children). *You put the peg and then the air can't come out of the balloon* (Rodrigo). After closing the opening of the balloon with the clothes peg, a new problem arises: how do we attach it to the straw on the wire? (...) In the absence of answers, to provide some help, I pick up the tape and, holding the balloon horizontally against the straw, I ask: *and now, what should we do?* Children suggest taping it. I tape the balloon to the straw on the wire, which is tied to the chairs.

d. Now, what do we have to do to make the balloon move?

- They assess their ideas against experimental evidence: the rectilinear motion of the balloon. Excerpt from the diary:

We remove the peg and the balloon "goes" (Mariana). *Where will it go?* - I ask. *It will move with the straw, that way* - says João, making a gesture with his hand in the direction opposite to the air outlet. I ask João to remove the peg from the opening of the balloon. There is great expectation across the room. João releases the peg and the balloon travels all the way, in a straight line, to the other end of the wire. At this point, the room is filled with excitement, a climate of euphoria and contentment with the outcome.

- They reflect on the experimental evidence. Excerpt from the diary:

After the euphoria dies down, the children are encouraged to think about what happened. *What made the balloon go forward?* - I ask. The children promptly respond that it was *the air coming out. Which way did the air go? That way* - Said Sara, referring to the opposite direction to the movement of the balloon. *It went backward* (Maria). *And which way did the balloon go?* - I ask. *It went forward* (Rodrigo). *It went the other way* - adds Beatriz. I repeat the experiment and ask some of the children to put their hand near the opening of the balloon when the clothes peg is removed. *What do you feel?* - I ask. The children say that they feel the "air coming out backwards".

e. Does the amount of air influence the distance travelled by the balloon?

- They devise a simplified plan mental.

Excerpt from the diary:

What should we do if we want that the balloon to only travel half of the way? - I ask. Beatriz answers promptly: *fill it with only a little bit of air*. The children agree with the idea and I ask them to imagine a "balloon rocket race". *What do we need to do?* - I ask. *We have two more chairs over there and two over here* (Maria); *We have two wires* (Sara); *We have to put the straw inside the wire* (António). With these suggestions, the children demonstrate that the assembly of the first circuit is very present in their minds. *What amounts of air should we fill the balloons with?* In the absence of answers, I give them some help, by rephrasing the question. *Should they be different or the same?* The children say they have to be different and Maria adds: *we have to fill one thiiiis big... And the other this tiny* (Rúben). *And how must the balloons be?* After a few moments, I ask again: *Should we use a small empty balloon on one case and a big empty balloon on the other?* Tentatively, they answer no, but when asked about how the two balloons should be, several of them say in unison: *identical...*

- They make predictions about which balloon will travel the greater distance.

Excerpt from the diary:

Which balloon do you think will win? Everyone thinks it is *Cristina's balloon* because *it is fuller* - it has a larger amount of air in it.

- They test their predictions. Excerpt from the diary:

With the help of the children, another circuit is built, arranged alongside the first one. *And now, what do we have to do to see which of the balloons will win?* - I ask. The children answer: *You have to attach the balloon to the straw. We put the peg* (António); *The peg stops the air from coming out* (Beatriz). I fasten the opening of the balloon with the peg and ask them how the balloon should be positioned. *The peg goes that way* - Says Beatriz, indicating that the opening of the balloon must be facing the nearest chair. *Why?* - I ask. Children justify their answers, saying: *because air comes out that way* (backwards) - several of them say. Igor adds: *because it comes out that way and then the balloon goes forward*. I ask two of the children to, simultaneously, remove the clothes pegs from the balloons, to start the race. At the end, the group expresses effusive reactions of excitement with the result of the "balloon rocket race".

- They collectively reflect upon the experimental evidence. Excerpt from the diary:

Who won the race? - I ask. *It was that one. It was the pink balloon* (several). *Why?* - I ask. *Because the other one had less air and this one had more* (Maria). *It was very full and it went farther* (Beatriz). *So, when the balloon has a lot of air, will it travel a long or a short distance?* The children state that *it will travel a long distance*, thus linking the amount of air in the balloon with the distance it travelled.

f. Collective recapitulation of the activity.

Encouraged to recapitulate all they had done and seen, children verbalize, clearly and sequentially, all the procedures performed:

We put the fishing line, duct tape, drinking straws, two clothes pegs and two balloons (João); *We inflated the balloon, then we taped it, put the peg and we let go; the peg was faced that way* - Points with his hand (Rúben); *To make the balloon go the other way, the air came out this way, and the balloon went that way* (Sara).

g. Record of the learning acquired

At the end, as a way to record the learning acquired, the children draw a sketch of the experimental activity. Examples:

Drawing 1 - The child's comment: *The fishing*

line is tied to the chairs and the balloon is attached with adhesive tape. When the air escapes, the balloon goes the other way and gets empty. The air makes the balloon go forward.

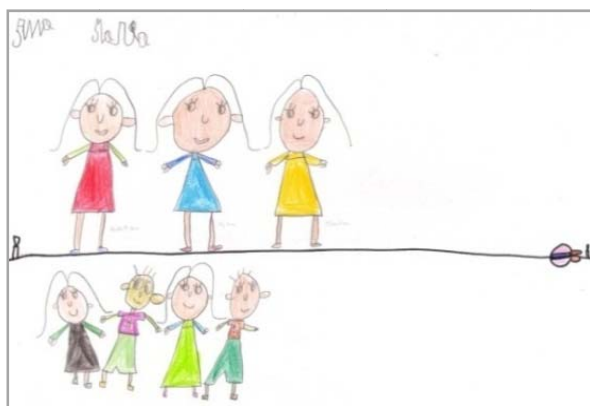

Figure 2. Drawing 1

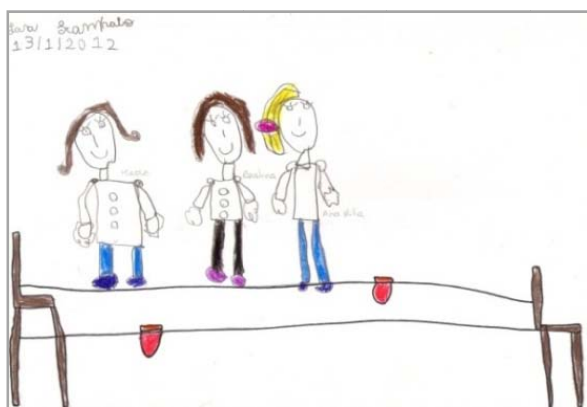

Figure 3. Drawing 2

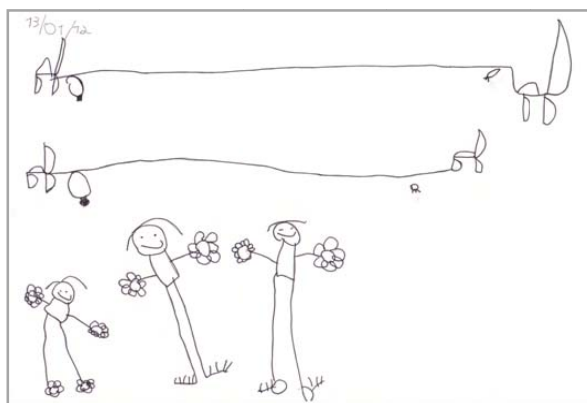

Figure 4. Drawing 3

Drawing 2 - The child's comment: *I conducted the experiment: the fishing line, the two balloons, the two clothes pegs and the chairs. Then I made a race. This balloon (pointing to the first one) was very full and it went all the way to the end. It won the race! The other only had a little bit of*

air and it lost, because it only travelled a little bit.

Drawing 3 - The child's comment: *I drew the balloon race, here they are (pointing to the inflated balloons), at the start, and then at the end. This one won (pointing to the top balloon) and the other lost because it didn't have enough air.*

6. Final considerations

The analysis of the process of exploring the "balloon rocket" activity shows, on the one hand, that the children are capable of overcoming challenges of a complex cognitive nature when these are approached in a collaborative context, of stimulation and freedom to express their thoughts. Thus, they become active and reflective agents in the learning process. On the other hand, the social interaction generated around the experimental activity, among the children and between them and the teacher, in addition to the mastery of language, promotes high levels of learning.

In the case described, the children begin by recognizing the existence of air inside an inflated balloon; they make predictions about what will happen to the air-filled balloon when it is released into the air in the room; they observe and describe the initial irregular motion of the balloon after being released; they construct and express meanings to the expression "straight-line movement"; they present ideas for the collective construction of a device to turn the irregular movement of the balloon into a rectilinear motion; they are faced with and reflect upon experimental evidence; they relate the direction of the air outlet to the direction of the balloon's displacement - opposite directions; also, they relate the amount of air in the balloon with the distance travelled along the wire; and they orally describe the entire experience. All this implies great intellectual and socio-emotional engagement by the children and it is inseparable from a planned intervention, intentionally guided by the adult, aiming to lead the children to acquire this learning.

In this sense, the analysis of the process of exploring the activity also shows that this group of teachers accomplished a successful didactical integration of the approach to experimental science recommended for children. The intentionality with which they conducted their educational action is in line with a reflective practice, in the way they regulate and provide

feedback to the children's joint cognitive activity, through continuous questioning, which stimulates reflection and action.

7. References

- [1] Harlen W, *Enseñanza y aprendizaje de las ciencias*. (2ª ed. atualizada), Madrid: Ediciones Morata, 2007
- [2] Eshach H, Fried MN. "Should science be taught in early childhood?," *Journal of Science Education and Technology*, vol. 14, n.º 3, pp. 315-336, 2005
- [3] Harlen W. "Evaluating Inquiry-Based Science Developments.," 11 May 2004.
- [4] National Research Council, "Inquiry and the national science education standards: A guide for teaching and learning," National Academy Press, Washington, DC, 2000
- [5] ME, *Orientações Curriculares para a Educ. Pré-Escolar*, Lisboa: GEDPE, 1997.
- [6] ME, "Organização Curricular e programas Ensino Básico – 1º Ciclo," Ministério da Educação. Departamento de Educação Básica, Mem Martins, 2004.
- [7] Sá J. *Renovar as Práticas no 1º Ciclo Pela Via das Ciências da Natureza*, Porto: Porto Editora, 2002.
- [8] Sá J. "Ciências experimentais na educação pré-escolar e 1º ciclo do ensino básico: perspetivas de formação de professores," em *Formar para a Educação em Ciências na educação pré-escolar e no 1º ciclo do ensino básico*, Coimbra, Edições IPC, 2003, pp. 45-78.
- [9] Charpack G. *As Ciências na Escola Primária: Uma Proposta de Acção*, Mem Martins: Editorial Inquérito, 2005.
- [10] Koch J, Appleton K. "The Effect of a Mentoring Model for Elementary Science Professional Development," *Journal of Science Teacher Education*, vol. 18, n.º 2, pp. 209-231, 2007.
- [11] Peixoto M. *As ciências físicas e as actividades laboratoriais na Educação Pré-Escolar: diagnóstico e avaliação do impacto de um programa de formação de Educadores de Infância*. Tese de doutoramento, Braga: IEP-UMinho, 2005.
- [12] Sá J, Varela P. *Ensino Experimental das Ciências: orientações metodológicas*, Porto: Porto Editora, 2010.

REGULATION OF GENE EXPRESSION – USING GENE REPORTERS LACZ AND MCHERRY TO ASSESS THE RESPONSE OF THE LACTOSE OPERON PROMOTER TO CATABOLITE REPRESSION AND POSITIVE INDUCTION

Catia Soares, Sofia Camarinha,
Susana Pereira

*Department of Biology, Faculty of Sciences,
University of Porto, Portugal
catiafilipasoares@hotmail.com,
sofia.camarinha.carvalho@gmail.com,
mspereir@fc.up.pt*

Abstract. *This activity main objective is to provide a hands-on approach to the regulation of lac operon in Escherichia coli and choose the best protocol to implement in schools.*

E. coli strains were transformed with two plasmids, with either the partial lacZ gene or the gene encoding for a red fluorescent protein, mCherry, under the control of lac promoter. Evaluation of the effect of metabolites on the expression of the reporter gene lacZ required chromogenic substrate X-Gal whilst visualization of expression of mCherry red protein was immediate and without the need of a UV source, proving a very convenient system to use in schools.

Keywords. lac operon, regulation of gene expression, positive regulation, catabolite repression, genetic transformation, reporter gene, red fluorescent protein, recombinant plasmid, mCherry

1. Introduction

Cells regulate gene expression to avoid unnecessary production of transcripts and proteins. For example, when cultured in a nutrient-poor medium, cells "turn off" genes that are not required for nutrient metabolism and thus decrease synthesis of RNA and proteins since transcription and translation are expensive energy processes. The most common mechanism of regulation in bacteria, occur upon messenger RNA transcription and genes that are controlled in this way are said to be transcriptionally



regulated [1].

Bacterial genes are typically switched off by repressor proteins that regulate expression by binding to a DNA sequence, the operator, adjacent to the promoter of an operon therefore blocking RNA polymerase from binding with the promoter and repressing operon gene expression [2].

This repressor activity is sensitive to a metabolite that signals the nutrient levels, so that bacteria can adjust their enzymatic machinery and its structural components, optimizing metabolism. Thus, organisms such as *Escherichia coli*, only synthesize the proteins necessary for survival in specific conditions [1]. In *Escherichia coli*, about half of their genes are clustered in operons. And each operon encodes enzymes that are involved in a particular metabolic pathway or interacting proteins to form a more complex protein [3].

An operon is a set of structural genes with a common promoter and regulatory sequences such as an operator that control the transcription of the structural genes which are transcribed into a single mRNA molecule. [4].

The lac operon of *E. coli* is a DNA segment that includes a promoter, an operator, and the three structural genes lacZ, lacY and lacA that code for lactose-metabolizing enzymes. The promoter is the RNA polymerase binding site, and the operator, located between the promoter and lacZ gene, is the repressor binding site. The repressor protein is encoded by the regulatory gene lacI, which is located upstream of the promoter [1]

Lac operon is negatively regulated by this repressor protein, but is otherwise inducible, since this repression can be inhibited by the presence of a ligand. In this case the repressor lacI, is inhibited by the ligand allolactose that directly binds to the repressor protein. Thus, lactose, from which allolactose is formed, induces the expression of the lac operon [2].

A second level of control of gene expression exists. In the presence of glucose which is used preferentially, the metabolism of other sugars is repressed, even in the presence of the inducer lactose. This type of control is termed catabolite repression.

This work aims to provide a hands-on approach to the study of the regulation of lac operon. We used two strains of *E. coli*, DH5- α and XL1-Blue, with different genetic characteristics in relation to the regulation of the lac operon. Both strains were transformed with two plasmids, pBluescript SKII, encoding the partial lacZ gene and a recombinant plasmid (pSKCherry)

containing a reporter gene, encoding a red fluorescent protein, mCherry under the control of the lac promoter [5].

Expression of reporter proteins was assayed in the presence of glucose and IPTG (isopropyl-beta-D-thiogalactopyranoside) a synthetic analog of lactose that inactivates the lac repressor and is currently used to induce expression of cloned genes under the control of the lac promoter [6].

The main objective of this work was the design of a laboratory activity that can be implemented in biology teaching in secondary education, specifically in the 12th grade.

2. Materials & Methods

2.1. Genetic characteristics of *E. coli*: DH5- α and XL1-Blue

To successfully design the experiment it is essential to be familiar with the properties of the *Escherichia coli* host strains used for the propagation and manipulation of recombinant DNA.

The type of plasmid vector and strains are important considerations when planning the experiment. For assaying β -galactosidase activity, the plasmid must contain the lacZ α , such as pBluescript. The *E. coli* strains should contain the mutant lacZ gene with deleted sequence (lacZ Δ M15), and some of the commonly-used cells with such genotype are DH5 α , and XL1-Blue. DH5- α and XL1-Blue possess only a small part of the lacZ that produces an inactive C-terminal of β -galactosidase; however, as soon as we transform the strain with the other part of the gene, the activity of the enzyme is established – this mechanism is called α -complementation. The assay of the activity of β -galactosidase requires X-Gal (5-bromo-4-chloro-3-indolyl-beta-D-galacto-pyranoside) an inert chromogenic substrate for β -galactosidase which hydrolyzes X-Gal, forming an intense blue precipitate and leading to the development of blue colonies upon induction of the lacZ gene with IPTG [7]. DH5 α cells do not require IPTG to induce expression from the lac promoter since they do not produce a significant amount of repressor lacI. On the other hand, IPTG is essential with XL1-Blue since this strain has overproduction of the lac repressor protein (lacIq gene mutation).

2.2 Plasmids

pBluescript II SK (here abbreviated to pSK) possess an ampicillin-resistance gene and a partial lacZ gene encoding a α -peptide of β -galactosidase. pSK vectors can be replicated in strains of E.coli like DH5- α and XL1-Blue which contains a chromosomal Δ (lacZ)M15 mutation [6] [8]. In the presence of X-Gal transformed bacteria will hydrolyze this compound and became blue.

mCherry is a red monomer which matures extremely rapidly, making it possible to see results very soon after activating transcription. This fluorescent red protein that can be seen without UV [9][10].

pSKCherry recombinant plasmid was previously created in our Department of Biology by insertion of a mCherry gene on a pBluescript II SK plasmid under the control of the lac promoter.

2.3. Transformation Scheme

All the experiments were performed by the flame to avoid contamination and media were sterilized with a microwave. Microwave sterilization is known to be as efficient as a normal autoclave and more likely to exist in school labs [11]. Chemo-competent XL1-Blue and DH5- α cells were prepared in CaCl₂ according to standard procedures [6].

For transformation, 5 μ L of each plasmid were added to 250 μ L of competent cells and the tubes kept on ice for 30 min.

Cells were then rapidly are transferred to a water bath at 42°C for 45 seconds for heat-shock and back on ice for 2 minutes. LB medium (Applichem) was added to each tube (250 μ L) and the tubes were incubated 1hour at 37°C with agitation for the recovery process While the tubes were on recovery process the LB-agar plates (Applichem) were prepared as depicted in Table 1. All experiments had a control plate with only LB-agar medium without supplements, otherwise all LB-agar plates were supplemented with ampicillin (sodium salt; Sigma-Aldrich) to a final concentration of 50 μ L/mL) to select for transformants.

For positive control of expression (XL1-Blue), 30 μ L of 0.1 M IPTG (Thermo Scientific) were spread on top of the plates.

In order to access the catabolite repression of the lac operon induced by glucose transformed DH5 α and XL1-Blue cells were plated in LB-

agar ampicillin medium supplemented with 2 % (w/v) glucose.

Strains	+ pSK	+ pSKCherry	NP
DH5- α	LB+X-Gal**+Amp****+Glu*****	LB+Amp + Glu	LB
	LB+X-Gal+Amp	LB+Amp	Amp
XL1-Blue	LB	LB	LB
	LB+X-Gal+Amp	LB+Amp	Amp
	LB+X-Gal+IPTG+Amp	LB+Amp+IPTG	N/A
	LB+X-Gal+IPTG+Amp+Glu	LB+Amp+IPTG+X-Gal	N/A
N/A: not applicable			

Table 1. Composition of media used on LB-agar plates for cells of both strains transformed with either pBluescript SKII (pSK) or pSKCherry and cells without plasmid (NP)

Activity of beta-galactosidase in pBluescript SK II transformants was assayed with the lactose-analog X-Gal (ThermoScientific). X-Gal solution (25 mg/mL) was prepared in DMSO and then 30 μ L were spread on top of each to agar plates. Aliquots of 100 μ L of cell suspension were spread on to the correspondent plates and incubated over-night at 37°C.

3. Results

The results observed are shown in Table 2. As expected in LB-agar plates NP cells grew in a continuous layer. In contrast, ampicillin-supplemented LB agar plates spread with the same type of cells (NP) showed no observable growth. In comparison cells transformed with either plasmid evidenced ampicillin resistant colonies.

The results observed are shown in Table 2. As expected in LB-agar plates NP cells grew in a continuous layer. In contrast, ampicillin-supplemented LB agar plates spread with the same type of cells (NP) showed no observable growth. In comparison cells transformed with either plasmid evidenced ampicillin resistant colonies. In the presence of glucose, colonies were white in both cases evidencing the repressor effect of glucose on the lac promoter. Since DH5 α strain does not express LacI, no inducer is necessary. For experiments with XL1-Blue-transformed strain, it is important to take into consideration that this strain has lacI^q gene, leading to a high expression of repressor lacI thus requiring the use IPTG as an inducer of expression of the operon.

Colonies were blue (pBluescript SKII transformed) or red (pSKCherry transformed)

only in the presence of IPTG presenting either a light blue or white colour respectively, in its absence (no, or feeble expression).

XL1-Blue transformed with pBluescript SKII, showed a white color in presence of glucose plus IPTG and X-Gal. XL1-Blue pSKCherry transformants also grew in white colonies in the presence of glucose plus IPTG.

4. Discussion

In general, results show that control NP cells, from both strains, grew in media without antibiotic while growing was repressed in medium with the ampicillin antibiotic. These results demonstrate that competent cells were healthy and that, ampicillin worked as a good mean of selection. *Lac* genes are expressed at high levels only when lactose is available and glucose is not. For genes to be expressed two regulatory proteins are involved: CAP and Lac repressor (*lacI*).

Table 2. Results observed for +pSK and +pSKCherry-transformed E.coli competent cells and NP (no plasmid) control cells on LB-agar medium and LB-agar media supplemented with ampicillin, X-Gal and IPTG. G indicates that colonies had grown and HG that colonies had high levels of growing; NG indicates that there is no growing; WC indicates that colonies had white-cream colors; B, means blue colonies; R, indicates red colonies.

When lactose present in the environment, allolactose is produced that can bind to the repressor (*lacI* protein), causing it to be unable to bind to the operator/promoter region, therefore no longer blocking RNA polymerase from transcribing the operon[12].

If lactose and glucose are present, the cell will use the glucose preferentially. A type of control known as catabolite repression acts to prevent lactose metabolism. A complex between the catabolite activator protein (CAP) and cyclic AMP (cAMP binds to the lac promoter site and is required for transcription of the lac operon. Glucose is known to lower the intracellular concentration of cAMP, thus inhibiting the activation of lac genes by the CAP-cAMP complex. When glucose levels are low, cAMP levels are high, so, CAP bind DNA and activate lac genes [1][3].









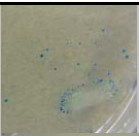

DH5- α		Observations	Photos
+ pSK	LB + Amp + X-Gal + Glu	WC, G	
	LB + Amp + X-Gal	B, G	
+ pSKCherry	LB + Amp + Glu	WC, G	
	LB + Amp	R, G	
NP	LB	WC, HG	
	Amp	NG	Ø
XL1-Blue			
+ pSK	LB + Amp + X-Gal	WC, G	
	LB + Amp + X-Gal + IPTG	B, G	
	LB + Amp + X-Gal + IPTG + Glu	WC, G	
+ pSKCherry	LB + Amp + IPTG	R, G	
	LB + Amp + IPTG + Glu	WC, G	
NP	LB	WC, HG	
	Amp	NG	Ø

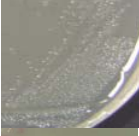
Table 2.

Although literature describes that with low levels of glucose, lac genes are expressed; our results show that glucose (20 mg/mL) can be effective

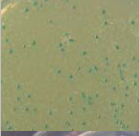
as a repressor of gene expression in both strains and with both plasmids. These outcomes are evident in pSK transformed DH5- α in plates with LB + Amp + X-Gal + Glu, and in pSKCherry transformed DH5- α in plates with LB + Amp + Glu. Also in pSK transformed XL1-Blue strain + in plates with LB + Amp + X-Gal + IPTG + Glu. In the absence of glucose colonies were blue (pBluescript SKII transformed) or red (pSKCherry transformed).

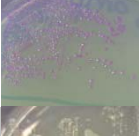
Both strains transformed very well with both plasmids but differences should be taken in consideration in the experiment planning. Experiments with XL1-Blue strain requires the use of inducer IPTG which allows to assay the inducing mechanism. On the other hand DH5- α transformants do not require IPTG being convenient for the assay of catabolite repression mechanism.

The assay for the presence of reporter beta-galactosidase in both strains always requires X-Gal, an expensive reagent for schools. On the other hand expressed fluorescent protein mCherry is immediately visualized without the need for substrate X-Gal. Furthermore the red color is visible without the need of excitation with a UV light source.

The use of fluorescent protein (GFP) as a molecular tag for studying cellular processes such regulation of *ara* operon has been successfully introduced (Bacterial Transformation Kit from Bio-Rad Laboratories [10]).

For schools, it is recommendable the use of the plasmid pSKCherry since the visualization of expression of the protein contrarily to other fluorescent protein reporters such as GFP does not require, a UV source.

5. Conclusion

Results obtained in strains transformed with pSKCherry are promising, since both repression of transcription with glucose (cells were white-cream) and induction of expression with IPTG (cells were red) were successfully illustrated. Therefore the use of pSKCherry transformed cells is recommendable since the visualization of expression of the protein does not require the more expensive X-gal, and furthermore, contrarily to other fluorescent protein reporters such as GFP, a U.V. source is not necessary.

The materials needed are not very expensive and experiments are amenable for teachers with

limited experience and requires few laboratory resources in schools.

6. References

- [1] Weaver RF. Molecular Biology- Fifth Edition. Mc Graw Hill; 2012.
- [2] Shaw K. Negative transcription regulation in prokaryotes. *Nature Educ.* 2002; 1(1).
- [3] Lodish H, Berk A, Kaiser CA, Krieger M, Bretscher A, Ploegh H, Amon A, Scott MP. *Molecular Cell Biology – Seventh Edition.* W.H. Freeman and Company: New York; 2013.
- [4] Pierce B. *Genetics: A conceptual approach.* 2nd Edition. W. H. Freeman and Company, 2005.
- [5] Shaner NC, Patterson GH, Davidson MW. Advances in fluorescent protein technology. *J. Cell Science* 2007; 120(24):4247–60.
- [6] Sambrook J, Russell DW. *Molecular Cloning: A Laboratory Manual*, Third edition (Cold Spring Harbor Laboratory Press, Cold Spring Harbor, New York. 2001
- [7] Casali N. editors. *Escherichia coli Host Strains.* Humana Press;1995
- [8] Singleton P. editor. *Dictionary of DNA and Genome Technology – Second Edition.* Great Britain: A John Wiley & Sons, Ltd.;2010.
- [9] Shaner NC, Campbell RE, Steinbach PA, Giepmans BNG, Palmer AE, Tsien RY. Improved monomeric red, orange and yellow fluorescent proteins derived from *Discosoma* sp. red fluorescent protein. *Nature Biotechnology* 2004;22(12):1567–72.
- [10] Mosher RH. Using pGLO to Demonstrate the Effects of Catabolite Repression on Gene Expression in *Escherichia coli*. *Bioscene* 2002; 28(3).
- [11] Fonseca MJ, Tavares F. Natural Antibiotics: A Hands-On Activity on Garlic's Antibiotic Properties. *The American Biology Teacher* 2011; 73(6):342–6.
- [12] Jacob F, Monod J. The operon: A group of genes with expression coordinated by an operator. *Comptes Rendus Biologies* 328, 514–520 (1960)



EXPERIENCE IN USING INQUIRY-BASED METHOD IN CHEMISTRY TEACHING

Mária Ganajová, Milena Kristofová

*Division of Didactics of Chemistry, Faculty
of Science, University of P. J. Šafárik,
Košice, Slovak Republic
maria.ganajova@upjs.sk,
milena.kristofova@upjs.sk*

Abstract. *In the paper we focus on presenting selected results of testing inquiry-based activities in chemistry teaching. Inquiry-based activities from the lesson Exploring Holes and Plastic and Plastic Waste prepared within the international ESTABLISH project were selected for testing. The individual inquiry-based activities are tested on primary and secondary school by teachers and pupils. The aim of the research was to find out to what extent implementing inquiry-based activities into science subjects teaching process, namely chemistry, influences pupils' attitudes to the subject, their opinion on science and technology and that on a scientist's job as well as to find out how interesting and useful pupils find the activities.*

Keywords. Inquiry-based activities, Inquiry-based method

1. Introduction

PISA research [1] pointed out that pupils in Slovakia had acquired a lot of scientific knowledge and theories. They have, however, difficulty in independent thinking about scientific problems and in investigating the problems on an appropriate mental level, including formulating hypotheses, looking for and suggesting possible solutions, interpreting collected data, making conclusions and stating arguments. The above shortcomings are closely connected with the prevailing methods of teaching in Slovak schools. The syllabuses in the subjects are overloaded and at the same time deductive way of teaching prevails despite the school reform and its effort to change both contents and quality of education.

One of the solutions that could contribute to increasing scientific literacy is undoubtedly changing the way of teaching science school subjects. It means changing existing teaching

methods based on acquiring quantity of information without emphasis on its practical use into ones that require a more active pupil's approach. An inquiry-based method, project-based teaching, pupil's experimental activity using modern technology, etc. [2] are considered to be appropriate methods which can make pupil active and interested in science. These can only be implemented in education if favourable conditions are created.

2. Methodology of Research

Within ESTABLISH project we created teaching material for physics, chemistry and biology containing inquiry-based activities with different level of inquiry. The partners involved in the project prepared several lessons from which chemistry lessons *Exploring Holes* and *Chemical care* have been transformed in agreement with the State Educational Programme in Slovakia. The lesson *Polymers* was prepared in cooperation with Charles's University in Prague. The lessons contain material for both teacher and pupils. The designed activities are accessible on the project web page www.establish-fp7.eu.by means of LMS system Moodle in English as well as in the official languages of the project participants.

2.1 Testing inquiry-based education

The lessons *Exploring Holes* and *Plastic and Plastic Waste* were selected for testing. Inquiry-based education as well as testing took place during the period November 2011 – February 2012. The aim was to find out to what extent implementation of inquiry-based methods in teaching science subjects, chemistry in particular, influences pupils' relationship to the subject, their opinion on science and technology and on the job of a scientist; how important are the activities for pupils and if they find them useful.

Testing was done on 249 pupils aged 11 – 15 and 41 pupils aged 15 – 17, at primary and grammar schools respectively and on 9 teachers.

Testing was carried out based on the scheme:

Pre-test – 3 inquiry-based lessons – post-test.

A questionnaire prepared within ESTABLISH project was used as a pre-test and post-test. 5 primary school teachers and 4 grammar school teachers were involved in teaching 3 lessons with inquiry-based activities. The teachers taught 3 lessons by means of inquiry-based method and

both the teachers and pupils completed the questionnaires.

Pre- test, post- test (questionnaire)

The test (questionnaire) consisted of three parts. The first part contained 13 statements (for primary school pupils) and 16 statements (for grammar school pupils) concerning pupils' relationship to science subjects. The second part dealt with pupils' opinions on the interviews presented in the questionnaire and on science subjects. In the last part of the questionnaire pupils expressed their opinions on science and technology. It contained 12 statements (for primary school pupils) and 16 statements (for grammar school pupils).

3. Results of Research

Due to extent restrictions of the paper only selected results are presented.

3.1. Hypothesis 1

Let us suppose that inquiry-based activities implemented in chemistry teaching process in the stated extent (3 lessons) will significantly improve pupils' attitude to science school subjects.

The hypothesis was verified by means of Chi-square test of good compliance in which the calculated figure was smaller than the table figure. That is why we refuse the zero hypothesis, i.e. inquiry-based activities implemented in chemistry teaching process in the stated extent did not significantly influence pupils' attitude to science school subjects.

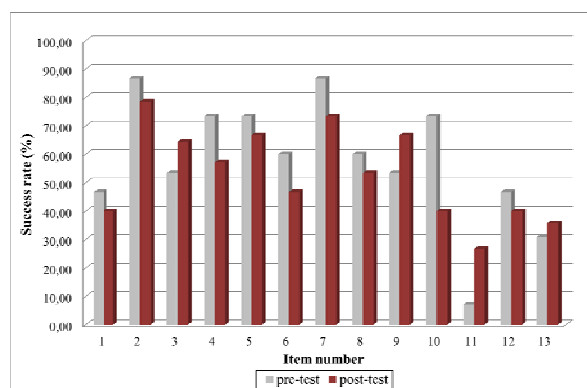

Figure 1. Primary school pupils' relationship to science school subjects

Statements to express opinion:

1. School science is a difficult subject.
2. School science is interesting.
3. School science is rather easy for me to learn.
4. I like school science better than most other subjects.
5. I think everybody should learn science at school.
6. The things that I learn in science at school will be helpful in my everyday life.
7. School science has increased my curiosity about things we cannot yet explain.
8. School science has increased my appreciation of nature.
9. School science has shown me the importance of science for our way of living.
10. School science has taught me how to take better care of my health.
11. I would like to become a scientist.
12. I would like to have as much science as possible at school.
13. I would like to get a job in technology.

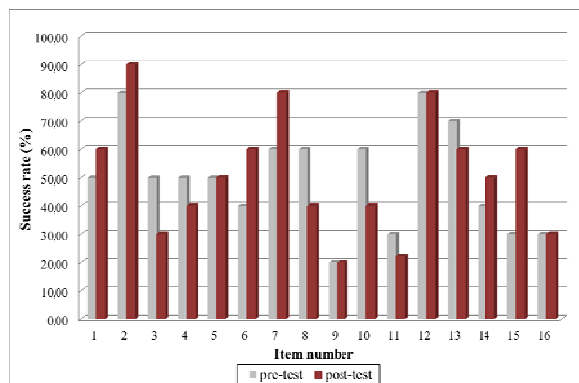

Figure 2. Grammar school pupils' relationship to science school subjects

Statements to express opinion:

1. School science is a difficult subject.
2. School science is interesting.
3. School science is rather easy for me to learn.
4. School science has opened my eyes to new and exciting jobs.
5. I like school science better than most other subjects.
6. I think everybody should learn science at school.
7. The things that I learn in science at school will be helpful in my everyday life.

8. I think that the science I learn at school will improve my career chances.
9. School science has made me more critical and sceptical.
10. School science has increased my curiosity about things we cannot yet explain.
11. School science has increased my appreciation of nature.
12. School science has shown me the importance of science for our way of living.
13. School science has taught me how to take better care of my health.
14. I would like to become a scientist.
15. I would like to have as much science as possible at school.
16. I would like to get a job in technology.

Discussion to the results of hypothesis 1 verification

Although verification of hypothesis 1 did not confirm any significant influence of significance of inquiry-based activities on pupils' relationship to the subject, 64,29% primary school pupils involved in testing stated in post-test that science subjects were easy for them, 66,67% pupils thought science subjects had showed them the importance of science for their way of life. In pre-test only 7,14% pupils stated they would like to become scientists, whereas in post-test it was 26,67% pupils. Their increased interest could have been influenced particularly by inquiry-based activities within classes. Interest in working in the field of technologies increased in 5% pupils after carrying out inquiry-based activities. We suppose it is necessary to apply the activities for a longer period of time and in several subjects simultaneously for achieving more significant differences.

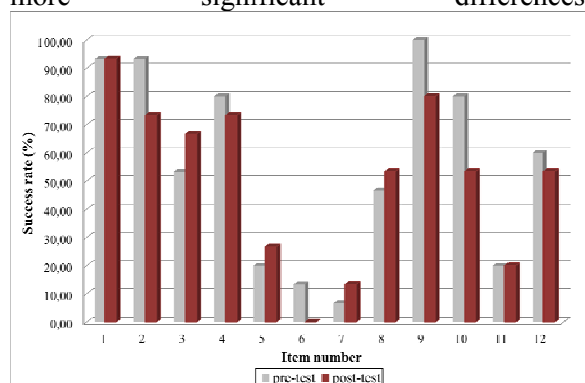

Figure 3. Primary school pupils' opinions on science and technology

Grammar school pupils in the post-test stated science subjects difficult (60% pupils) but at the same time as many as 90% stated them interesting. After carrying out inquiry-based activities 20% more pupils agreed that all pupils should learn science subjects at school. 80% pupils thought that the knowledge acquired in science classes would help them in everyday life. There was also an increased interest in becoming a scientist (by 10%) and in taking as many science classes as possible (by 30%).

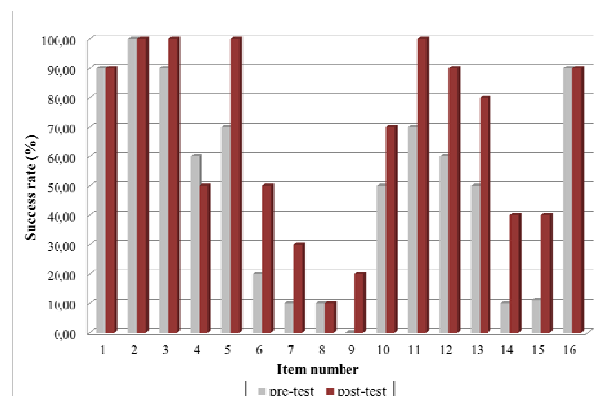

Figure 4. Grammar school pupils' opinions on science and technology

3.2. Hypothesis 2

Let us suppose that inquiry-based activities implemented in chemistry teaching process in the stated extent will influence pupils' opinions on science and technology.

The hypothesis was verified by means of Chi-square test of good compliance in which the calculated figure in case of grammar schools was bigger than the table figure. That is why we do not refuse the zero hypothesis. The hypothesis was proved for grammar schools. For primary schools, however, it was not proved.

Statements to express opinion:

1. Science and technology are important for society.
2. Science and technology will find cures to diseases such as HIV/AIDS, cancer, etc.
3. Science and technology make our lives healthier, easier and more comfortable.
4. New technologies will make work more interesting.
5. Science and technology will help to eradicate poverty and famine in the world.
6. Science and technology can solve nearly all problems.

7. Science and technology are helping the poor.
8. Science and technology are the cause of the environmental problems.
9. A country needs science and technology to become developed.
10. Science and technology benefit mainly the developed countries.
11. We should always trust what scientists have to say.
12. Scientists are neutral and objective.

Statements to express opinion:

1. Science and technology are important for society.
2. Science and technology will find cures to diseases such as HIV/AIDS, cancer, etc.
3. Thanks to science and technology, there will be greater opportunities for future generations.
4. Science and technology make our lives healthier, easier and more comfortable.
5. New technologies will make work more interesting.
6. The benefits of science are greater than the harmful effects it could have.
7. Science and technology will help to eradicate poverty and famine in the world.
8. Science and technology can solve nearly all problems.
9. Science and technology are helping the poor.
10. Science and technology are the cause of the environmental problems.
11. A country needs science and technology to become developed.
12. Science and technology benefit mainly the developed countries.
13. Scientists follow the scientific method that always leads them to correct answers.
14. We should always trust what scientists have to say.
15. Scientists are neutral and objective.
16. Scientific theories develop and change all the time.

Discussion to hypothesis 2 research results

Primary school pupils were not influenced by the inquiry-based activities within the lesson *Exploring Holes*, the activities did not significantly influence their opinion on science

and technology. This is probably due to the fact that primary school pupils do not have an idea about scientist's work and they see inquiry-based activities more or less as a game.

Grammar school pupils' opinions on science and technology, on the contrary, were influenced by inquiry-based activities more significantly. All of them (100%) said in the post-test that thanks to science and technology future generations would have more opportunities and their work would be more interesting due to new Technologies. They also thought that science and technology were needed by every country in order to develop. 90% of them thought that science and technology helped mostly developed countries. The results are connected with the fact that grammar school pupils are able because of their age differences to perceive real state of society.

4. Conclusion

Although testing inquiry-based activities in pupils did not confirm their significant influence on pupils' relationship to the subject (as it turned out that was due to short time of the method implementation), it did prove pupils' interest in such a way of education, the fact which was manifested in the change of grammar school pupils' opinion on the importance of science for life. The number of pupils claiming that they would like to become scientists had also grown. Pupils started to perceive chemistry as more comprehensible.

The teachers appreciated the fact that pupils do not get ready information but by carrying out practical tasks and by mutual communication they acquire knowledge that will be long-lasting. Pupils learn to perform scientific activities, be responsible, work in teams, be tolerant, communicate, express their opinions. The disadvantage was seen in the fact that it is rather demanding for a teacher because they have to prepare trials and it is also time-consuming in the class.

The answer to the question „*How can you manage to deal with the complete syllabus and at the same time to implement inquiry-based activities that are rather time consuming?*“ can be found in the experience of foreign teachers, who have been using the IBSE method for a longer period of time. According to them it is necessary to reduce the contents, stop teaching unnecessary facts, and concentrate rather on pupils' understanding the subject matter (which requires to go into a detail in a particular topic)

and developing their key competences. Research also suggests that „go through everything“ approach gives few opportunities to acquire something else than slight knowledge.

A lot of teachers abroad apply the method in combination with the traditional way of education and therefore they do not teach every lesson by means of IBSE method. If achieving a lesson's goal requires, they choose traditional method of presentation, explanation, demonstration of experiments, etc. It can be assumed from the above that traditional education should function as the basis which should be combined with IBSE method.

Acknowledgements

The paper has been written within the project KEGA č. 027UPJŠ-4/011 financed by Ministry of Education Slovak Republic and within the project ESTABLISH (7th General Programme of EU, FP7/2007-2013 based on the n° 244749 agreement).

References

- [1] The National Report OECD PISA SK (2006). Bratislava: National Institute for Education.
http://www.iuventa.sk/files/documents/7_vyskummladeze/en%20verzia/pisa2006nsprava.pdf
- [2] Holec, S., Kmeťová, J.: Testovanie prírodovednej gramotnosti PISA; 2006.
http://www.statpedu.sk/files/documents/publikacna/rozvoj_funkcnej_gramotnosti/holec.pdf



PROJECT ESTABLISH - CHEMISTRY AND BIOLOGY

Věra Čížková¹, Hana Čtrnáctová¹,
Mária Ganajová², Katarína Kimáková²,
Petr Šmejkal¹

¹Charles University in Prague, Faculty of
Science, Czech Republic

²P. J. Šafárik University in Košice, Faculty
of Science, Košice, Slovakia

veciz@natur.cuni.cz

ctr@natur.cuni.cz

maria.ganajova@upjs.sk

katarina.kimakova@upjs.sk

psmejkal@natur.cuni.cz

Abstract. *Now, it's clear that the thinking about changes in science education is topical in the whole EU. This is why innovation of contents, and especially new teaching methods, are starting to draw attention. One of them is the IBSE method. This way of, according to what was gathered so far, has proved its effectiveness in secondary education, partly by increasing the students' interest in science, partly by improving their results and arousing the teachers' motivation. This is why the topic of IBSE was chosen as the dominant theme of the project 7th FP EU ESTABLISH. The contribution deals with the concept of the IBSE method in the ESTABLISH project and with creation of the educational materials.*

Keywords. Secondary education, Science education, IBSE method, ESTABLISH project

1. Introduction

Pedagogical and didactics studies showed that the students' interest in science is low, falling, and in most countries the students' scientific knowledge is merely below average. This despite the fact, that the science and mathematics are necessary for further economical and social development, and that the basic measure of human capital is the educational level of the citizens (European Commission, 2007).

For this reason, EU has started with an intensive research into the problematic of disinterest in science and the way it's taught. An expert group was created in order to analyze the teaching and find out the reasons for disinterest in science. This group published its results and

recommendations in the report *Science Education Now: A Renewed Pedagogy for the Future of Europe* (European Commission, 2007). The main way to ensure the change should be the innovation of the contents and mainly the application of new pedagogical methods, namely those that use Inquiry Based Science Education (IBSE) during the lessons.

Currently, the EU funds, via 7th frame program for research and development, four big international projects (among others) that research the problematic of education and teaching of mathematics and science. They focus not only on research, but also on introducing and quick spreading of their own results into the teaching practice at primary and secondary schools.

The contribution deals with the concept of the IBSE method in the ESTABLISH project, with creation of the teaching and learning materials, with their verification and with the analysis of results.

ESTABLISH project brings together expertise from across 14 institutions in 11 European countries in order to extend the use of inquiry based science education (IBSE) in secondary schools across Europe.

The aim of this project is to promote innovation in classroom practice through the provision of appropriate teaching and learning IBSE units and appropriate supports for both in-service and pre-service teachers to implement IBSE (McLoughlin et al., 2011).

The project consortium have adopted an agreed definition of inquiry/elements of inquiry as the “intentional process of diagnosing problems, critiquing experiments, and distinguishing alternatives, planning investigations, researching conjectures, searching for information, constructing models, debating with peers, and forming coherent arguments” (Linn, Davis, Bell, 2004). The individual elements of inquiry were identified based on this definition and extended group discussions. The consortium has developed teaching and learning units to be used in teacher education – both pre-service and in-service – that are good examples of IBSE. It also developed an agreed framework for the development of an IBSE unit that requires the developers to describe (McLoughlin et al., 2011):

- (1). Unit/science topic
- (2). IBSE character
- (3). Pedagogical Content Knowledge
- (4). Industrial Content Knowledge

(5). Learning Path(s)

(6). Student Learning Activities and Classroom Materials

Using the framework, central IBSE units are developed with contributions from several project participants and through piloting in each country by the consortium members working with teachers. The central unit is then adapted for implementation in each country, taking into account cultural and curriculum differences (McLoughlin et al., 2011).

The criteria for each ESTABLISH Inquiry Based Science Unit is that they conform to the ESTABLISH definition of Inquiry Based Science Education (IBSE) and encourage and facilitate students to be active learners.

The total number of units will be rather high, and should reflect these different needs. Also it will be beneficial to have different versions from the same topic, or an easy way to adapt the units to specific situations.

Three units from biology and chemistry were prepared at Charles University in Prague - Faculty of Science and P. J. Šafárik University in Košice - Faculty of Science.

2. Polymers around us

The unit is focused on studying plastic and plastic waste. It is divided into three subunits.

The first subunit deals with getting to know plastic, its marking, separation and recycling. Due to its properties, plastic has a wide range of use in all spheres of human activities. In competition with classical materials, mainly metals, polymers have succeeded mostly because of their easy processing, low density and a convenient ratio of utility qualities and price. Pupils acquire knowledge of plastic from everyday life and they will deepen it in this subunit. They will learn to identify symbols used to mark plastic and those on plastic packing and they will verify different properties of plastic by experiment.

Using plastic is closely connected with the issue of plastic waste disposal. Plastic does not decompose by itself; therefore it accumulates in the environment.

Subunit 2 deals with plastic waste. Within different activities pupils have to think about the issue of waste disposal, discuss it with classmates and propose possible solutions. Pupils should work out that recycling is an effective solution to the problem of plastic waste disposal.

They should understand why it is necessary to recycle and realize that every individual can contribute to the improvement of the environment by correct and regular separation.

In the subunit 3 pupils/students will study various polymers, their physical and chemical properties and then, on the basis of acquired experience, they will estimate their practical and industrial exploitation and they will seek their both existing and possible applications. They will think of polymers occurring in their surroundings, reasons for application of the given polymer (why PVC was used for the particular toy), further they will analyze them by several tests (flame test, polymer density, etc.) and propose the applications of polymers.

2.1. Pedagogical Content Knowledge

Discussion, managed discussion. Pupils discuss eg. "Issue of produced waste from the point of view of the environment". A teacher together with pupils discusses recycling of different materials as well as plastic and its use. Pupils discuss the results of the experiment and conclusions drawn from it.

Problem-based teaching - teacher consistently gets pupils involved in the process of looking for and finding solutions to problems – e.g. pupils look for possibilities of waste disposal. A model task: Compare the life cycle of a glass and plastic bottle and try to produce a graph of the two cycles.

Group and co-operative teaching - a group is made up of two to seven pupils. A task for the group: How is plastic made? Find at least two ways of its production. Pupils present conclusions they arrived at in groups. They can use the information they have looked up on the Internet.

"Why do people produce such an amount of waste? What reasons do we have to separate it? Can you separate waste correctly? Why don't some people separate waste?"

Project-based teaching - the basis of the method is tackling a task of a complex character. The whole activity 5 is focused on project-based teaching. The results of pupils' work are not only answers to the questions in the worksheet but also their presentation either by

PowerPoint or a poster presented in front of the class, eg. "Draw simple comics: From the life of PET bottles". Practical method include carrying out chemical trials by which pupils not only observe phenomena but also effect them in an

active way – they prepare, manage, and evaluate chemical process themselves. Based on carried out experiments pupils acquire knowledge on properties of plastic in the lesson.

3. Water in the life of man

The basis of every life is water. It is the main component of organisms. If there were no water, plants would die, animals would die of thirst. Water affects both living and inanimate nature. Water is really very important. People could not live without water. Today, every home has plenty of water, which is supplied by water mains or pumped from the well. We can buy bottled water. But from where is water taken? How is it that it is clean and drinkable? What would happen if nothing like this existed?

In terms of our requirements, the main topic of the unit is fluid intake, a relationship between man and water and importance of kidneys for the life of man. Students will think about their fluid intake and learn about the process the water undergoes before it gets to our house e.g. in the form of Coca Cola. In addition they will learn how our body processes the fluid supplied and what the role of kidneys in this process is. While working, students will gain knowledge of human biology, geography, chemistry, physics and also technology.

3.1. Pedagogical Content Knowledge

Topic of water represents four interconnected planes.

Water in the human body performs many important and unique functions - for example, it is an essential component of cells, an important component of biochemical reactions, solvent of substances, and further it serves to transmit the nutrients and other necessary substances (hormones, metabolites, antibodies...) or creates the systems equalizing the temperature of the body.

As drinking water we can consider healthy water, which even through a continuous consumption does not cause diseases or ill health by the presence of microorganisms or substances affecting by acute, chronic or late effects the health of individuals and their offspring. In addition, its sensory properties and quality do not impede its use for drinking and sanitary needs of individuals.

Activity	Subject
1. Kinds of packaging plastic materials and their labeling	Chemistry Technology
2. Properties of plastic materials	Chemistry Physics
3. Resolubility of waste in the environment	Chemistry Technology, Biology
4. Separation of waste	Chemistry Technology Physics
5. Influence of acid rains on plastic products	Chemistry
6. Materials around us and what plastics and polymers are	Chemistry Technology Biology
7. Polymerization – polycondensation	Chemistry Technology Biology
8. Cross-linking of polymers	Chemistry Physics
9. Preparation of polymers, influencing their properties	Chemistry Physics
10. Properties of polymers	Chemistry Physics
11. Properties of polymers – elasticity and cross-linking	Chemistry Physics
12. Properties of polymers – dissolution of polymers	Chemistry
13. Identification of polymers	Chemistry Physics
14. Application of polymers	Chemistry Technology Biology
15. PAIRS	Chemistry Technology
16. Where can I find the polymer?	Chemistry
17. Estimate and discuss some information regarding polymers	Chemistry Physics
18. Pointing out the importance of polymers in everyday life	Chemistry Everyday life

Table 1. List of activities - unit Polymers around us

Activity	Subject
1. Discussion over the importance of water	Biology
2. My water intake	Biology
3. Which water tastes better, bottled or tap water?	Technology Biology Chemistry
4. Waterworks or production of drinking water	Technology Biology Chemistry
5. Can we get drinking water?	Biology Geography
6. Analysis of beverages	Technology Biology, Mathematics
7. How does the water travel through our body after drinking?	Biology
8. How is finite urine formed?	Biology Chemistry
9. Importance of kidneys for life	Biology
10. Is it possible to develop an artificial kidney?	Biology Chemistry Physics Technology
11. A visit to a dialysis centre	Biology Chemistry Physics Technology
12. World Kidney Day	Biology

Table 2. List of activities – unit Water in the life of man

Currently, drinking water is obtained by treatment of surface water in waterworks or water from underground springs or wells.

Water taken in beverages and food or formed in metabolic processes is absorbed in the small intestine, and a lesser portion also in the colon. This is done on the basis of different concentration, osmosis, in the presence of minerals of sodium and potassium. Unused, spent, water is excreted from the body through saliva, gastric or pancreatic juice, bile, intestinal secretions and faeces. The main dispensing of water is done through the urine, kidney filtration, vapour in breathing or evaporation and skin sweating.

This method allows removing toxic waste products of metabolism and excess water from the blood using a special dialysis unit popularly known as "artificial kidney". Patients with kidney failure usually come to haemodialysis

three times a week to the so-called dialysis centres.

The aim is that students gain a comprehensive view of water as an important component of the human body through practical tasks that require investigation thinking from students. The main topic of the unit is the production of drinking water and haemodialysis.

This is an example of HSCI conference submission. These guidelines include complete description of the paper style including formatting, fonts, spacing, and related information for producing your proceedings manuscripts. Please follow them and if you have any questions, send them via e-mail to the conference organizers.

4. Blood Donation

Activity	Subject
1. Appeal for donating blood	Biology
2. Looking up information	Biology Technology
3. Study visit at a transfusion centre	Biology Physics Chemistry Technology
4. Separation of blood constituents	Biology Physics Technology
5. Scientific conference	Biology
6. Interview	Biology
7. Determining blood types	Biology Chemistry
8. Is Pavol the father?	Biology
9. Blood as a transporter	Biology Chemistry
10. Blood as a guard	Biology
11. Blood preservation	Biology Chemistry Physics
12. Is it possible to produce artificial blood?	Biology Chemistry Technology

Table 3. List of activities – unit Blood donation

Blood is a unique organ in which cells are not bonded together but move freely in plasma. Blood plays an important role in the human body: it transfers oxygen and different substances to places of their effect or processing by cells and carries waste products from tissues so that they could be removed from the body. Significant lose of blood in an accident puts a person in a mortal danger. Additionally, there are

diseases in which blood does not carry out one of its functions. Blood transfusion can save a human life in these situations. Up to the present there has not been found/created anything blood could be substituted by.

This unit focuses on blood properties, blood donation and conditions that must be ensured so that transfusion would not endanger patient's life.

Students are given an opportunity to look up information on their own, to process and present this information, work in a team and identify with roles of different experts. They become familiar with aids necessary for taking blood and for its storage. They plan experiments and perform observation.

4.1. Pedagogical Content Knowledge

Existing previous experience of students is based on the fact, that each of them has been injured, has bled and undergone blood tests. They all are also familiar with the fact that in a hospital blood is not only taken from the patients but there are situations when, in contrary, it has to be added to the body to prevent some patients from dying.

Presenting a topical article or local media news that appeal to people to donate blood can be motivating. Students must think why such an appeal has been published and imagine the situation a person in the need of other people's blood might be in.

Biological content is made up of composition, functions and properties of blood. The topic is related to the activity of circulatory and respiratory systems. We assume that pupils have already learnt about blood circulation in circulatory system, about activity of a heart and about gaseous exchange in lungs and tissues. In this unit they will learn about other properties and functions of blood by means of practical tasks, looking up and interpreting information.

Technologies are represented by polymers (plastics) and metals which are used in making aids for taking, processing, transport and storing of blood as well as equipment used to ensure sterility of aids utilized when handling blood. Students also learn about polymers that support long term storage of blood at very low temperatures by protecting cells from being damaged in the process of ice crystals growth. Also of some interest is the information about efforts of scientists to develop a blood substitute which could save life in emergency when there is no suitable donor available.

5. Pilot testing inquiry-based education in teachers

Teachers used an opportunity to talk to researchers. By means of discussion with teachers who had implemented inquiry-based activities in their classes we were able to obtain authentic opinions, the extracts of which we are presenting. The question: "Do you think that this lesson can foster student's knowledge and skills development?" was answered by teachers that a student will be able to apply the acquired knowledge in everyday life, they will be able to work in a team, advise and help others. The question: "Do you think that it can influence development of student's attitudes to science, to science of learning, learning in general, or to something else?" was answered by teachers: „the attitude of their students to work has changed with carrying out experiments – they use their creativity and are more independent in research and doing tasks.“

Although at the beginning teachers were rather pessimistic due to the fact that they had often experienced their student's being passive and unwilling to co-operate or to work independently, pupils became used to such a way of instruction with time thanks to gradual and consistent implementation of IBSE methods.

The following are considered the main advantages of such a type of education: students do not receive ready information but by means of doing practical tasks and by mutual communication they acquire long-lasting knowledge, students learn to be independent, work in teams, be tolerant, communicate and express their opinions. By means of the activities several key competences are developed in students (communicative, social, digital, mathematical) and the activities motivate students towards the interest in science. Problem aspects in implementing the method were seen in the fact that inquiry-based education was more demanding for teacher from the point of view of both time and material.

5. Conclusion

The science education problems in the Czech and Slovak Republic are analogical to those of the other countries of the central and Eastern Europe. The subject matter is more of an academic and encyclopedic type, which, of course, supports the students' disinterest. The deductive teaching methods are much more common than the

inductive ones; most of the subject matter is composed of facts, not of methods that would allow the students to find the facts out for themselves. Partnership in solving the ESTABLISH project is no doubt a significant opportunity for changing this situation.

It's clear that there is a long road ahead as far as the realization of new ways to teach science subjects at secondary schools goes. We hope that the solving of the ESTABLISH project will contribute majorly towards it.

6. Acknowledgements

ESTABLISH project: European Science and technology in Action: Building Links with Industry, Schools and Home (244749-FP7/2007-2013) in 7th frame European Union program.

7. References

- [1] Bell RL. Perusing Pandora's box: Exploring the what, when, and how of nature of science instruction In: Flick LB. & Lederman NG. (eds): Science inquiry and nature of science. Implications for teaching, learning, and teacher education. Dordrecht: Springer, 2004 pp. 427-446.
- [2] Čížková V. Čtrnáctová H. Science Education in Context of Requirements of Current Society. In: Lazar B. Reinhardt R. (eds): Socio-cultural and Human Values in Science and Technology Education – XIVth IOSTE World Symposium Proceedings (CD ROM). Ljubljana: Institute for Innovation and Development of University 2010
- [3] Eastwell P. (2009). Inquiry learning: Elements of confusion and frustration. *The American biology teacher*, 71, (5), 263-264.
- [4] European Commission (2007). *Science Education Now: A renewed Pedagogy for the Future of Europe*: Report of the High-Level Group on Science Education Brussels, EC Directorate -General for Research: available at: http://ec.europa.eu/research/science-society/document_library/pdf_06/report-ocard-on-science-education_en.pdf
- [5] Finlayson O. et al. (2011). Invisible Holes – Iquire Unit in Chemistry. In: *Science Learning Et Citizenship – Proceedings of the 9th ESERA Conference*. Lyon: ESERA.
- [6] Linn MC, Davis EA, Bell P. (2004).

- Internet environments for science education.* Mahwah, NJ: Lawrence Erlbaum, pp. 3-38.
- [7] Ganajová M, Šmejkal P, Čtrnáctová H. (2011). Report on pilot testing of subunits Invisible holes and Visible holes (Exploring holes teaching unit) in Slovakia and the Czech Republic. In: *ESTABLISH project meeting (June 2011)*. Umea: University of Umea.
- [8] McLoughlin E. et al. (2011). Developing Inquire Based Science Education Teaching and Learning Materials. In: *Science Learning Et Citizenship – Proceedings of the 9th ESERA Conference*. Lyon: ESERA.
- [9] Okemura A. (2008). Designing inquiry-based science units as collaborative partners. *School library media activities monthly*, 25 (3), 47 – 52.
- [10] Papáček M. (2010). Badatelsky orientované přírodovědné vyučování – cesta pro biologické vzdělávání generací Y, Z a alfa? *Scientia in educatione*, 2010, 1(1).
- [11] Teissier JT. (2004). Ecological Problem-Based Learning: An Environmental Consulting Task. *The American Biology Teacher*, 2004, roč. 66, č. 7, s. 477-484.
- [12] Wolf M, Lafarriere A. (2009). Crawl into Inquiry-Based Learning. *Science Activities*, 2009, roč. 46, č. 3, s. 32-38



PHENOMENOLOGY IN SCIENCE EDUCATION

F. Caglin Akillioglu
caglin@gmail.com

Abstract. *This paper investigates the relevance of phenomenology to science education. It hypothesizes how phenomenology can be used as a tool for promoting meaningful learning as a holistic process in science classrooms as well as reshaping science education reform and emerging new science. By approaching it both as a philosophy of knowledge and a research methodology, this paper also tries to connect the theory and practice of science education through the lenses of phenomenology. Recent reform efforts of science education prioritize closing the gap between students' daily lived-experiences and classroom applications while promoting*

their understanding of nature of science. Non-holistic approaches to the nature of science either focus on the tentative nature of empirically based truth claims and the uncertainty in scientific investigation or the relation between hypothesis and evidence in the scientific process. Unfortunately, when they are exposed to only one aspect of the nature of science, students tend to develop misconceptions and perceive science either as too methodological or not very reliable. To help students understand the goal of science as the construction of ever-deeper explanations of the natural world and adopt the paradigm of emerging new science, their understanding of the nature of science needs to be a holistic experience. Contemporary reform movement in science education recognizes the importance of active engagement of students which is the main focus of phenomenological view of knowledge construction. However, this reform's strong emphasis on the construction of conceptual knowledge rather than experience seems to be lacking the contextual and broader view of holistic approach. Regarding this limitation phenomenology might play a significant role in science education. It might provide opportunities to relate conceptual models of scientific knowledge to students' life-experiences by connecting abstract knowledge to being and acting in the world. Phenomenology sees object-subject relation as a non-dualistic whole and considers all human experience equally valuable for understanding lived experiences, meaning making processes and knowledge construction. Therefore, the new framework of science which assumes that there is a structural interference of the subject in the object under observation resonates with this approach. This new paradigm of science also promotes the notion of interconnection through perceiving reality in terms of relationships and integration and imposes science education to become compatible with phenomenological epistemology. In addition, as a methodology phenomenology focuses on the values of the direct lived-experiences of things. In science education this corresponds to constructivist pedagogy and inquiry based learning. Moreover due to its discovery oriented nature phenomenological research has the potential to be used for enriching abstract scientific models with contextual and experiential background. Phenomenology uses sense experience as a starting point for systemic investigation, reflection and understanding which might

provide invaluable opportunities to tie students' daily lived-experiences directly to classroom applications of science. Phenomenology has a considerable potential as a tool for science education. The role phenomenology might play in connecting students' everyday lived-experiences to abstract and conceptual scientific knowledge by providing a rich contextual and experiential learning environment is something that we should not overlook.



A VIEW OF PROBLEMATIC OF FISHERIES AND AQUACULTURE IN EUROPE

Sonia Borges Seixas
soniabseixas@gmail.com

Abstract. *EU citizens are consuming far more fish than European seas can produce by catches and aquaculture, this conducts in importation of 60% of it fish consumption. Some studies also showed that the consumption of fish in EU countries was below the recommended values for human health, so the level of consumption tends to rise. By other hand almost of the fish stocks is fully exploited and can conducts to environmental problems. Some examples were mentioned. The sustainability of fisheries is an EU priority today, as demonstrated the new Common Fisheries Policy. In last two years several recommendations and rules have been done to achieve this objective. By other hand is important educate the consumers to change mentality and conduct them to consume fish catch by sustainability fisheries. Also was implementing several certifications, regional (origin certification) and international. At this point aquaculture is considered a solution to provide fish to EU but some problems are constricts their rise, such as consumer mentality, tourism competitive for coastal areas, environment problems, etc. Several examples were mentioned. In all these problem education of different actors is a big concern. So Aquatnet project, an EU Erasmus project (actually in third edition), study the pr0blem and try to contribute to the solution of this problem.*



OVERVIEW OF THE IMPACT OF IBSE TRAINING COURSES ON LEARNING STEM IN PRIMARY AND SECONDARY SCHOOLS

**Luminita Florentina Chicinas,
Nicolae Micescu**
LChicinas@gmail.com

Abstract. *This paper presents an overview of the impact study realized in five Romanian counties in order to assess the effectiveness and effects of IBSE training courses implemented in last 3 academic years on the quality of STEM learning. The study was realized both on STEM teachers which attended and implemented IBSE lessons as well as on their pupils by means of focus groups, interviews and questionnaires. Also, by means of schools' inspection (the quality of curriculum aspect and, respectively, quality of teachers' teaching and quality of pupils' learning results and products), we gathered data about IBSE learning activities useful in order to obtain the most complete and realistic image of learning quality improvement as a function of pupils' age. An other perspective came from the analyze of training courses implemented during last 3 years: SCeTGo, KLiC, Pathway, MaST Networking courses that induced important changes in the ideas and behavior of STEM teachers in their classrooms, changes that influenced the pupils attitude toward learning these generally considered "difficult subjects". We noticed that, both in formal learning activities designed in school environment or in non-formal learning environments, when pupils have to verify or prove a scientific statement by means of scientific investigation or team project work in order to solve specific problems, they learn more effectively and became more self confident in order to explain, argument, justify their answers, solutions or opinions. Also, an other important aspect is that during the academic year while preparing to attend the next science festival edition (organized by Science on Stage - Romania), every year, there is an improvement of the quality and complexity of the research themes, scientific projects and devices presented by primary, secondary and upper secondary school pupils. Last, but not least, teachers' attendance at workshops and specific*

activities for them in partnership with Romanian universities and research institutes had a significant effect in the improvement of their teaching, of their style, in their attitude more flexible and open to the pupils' questioning. Finally, this paper presents a selection of good examples practices and best projects shortly described in order to sustain and also illustrate the main results of the theoretical study.



SCIENCE ON STAGE EUROPE

David Featonby
featonby@onetel.com

Abstract. Science on Stage Europe is a Pan European organisation which brings together teachers from most European Countries, in order to share best practice, through its conferences every two years and national and international follow up activities and newsletters. The stand will display some of the best activities from the 2013 in Slubice (Poland) and will also have details of the forthcoming June 2015 conference in London. The conferences are fully funded and teachers may apply through their national steering committees for free places, a certain number of which are allocated to each nation. Further details may be found on the Science on Stage website www.science-on-stage.eu



SCIENCE WITH SENSORS IN PRIMARY SCHOOLS

Ewa Kedzierska, Ton Ellermeijer
Ton@cma-science.nl

Abstract. The use of ICT in Physics Education is well-known for many years, and has proven to stimulate f.i. more authentic and inquiry-based education. Already for 25 years CMA has developed the learning environment Coach for science education. Coach includes a.o. tools for measurement with sensors, measurement from videos, powerful analyzing tools including Modeling and authoring facilities to create activities adapted for age 10 – 20.

In more recent years a special interface has been developed having Primary schools (and their teachers!) in mind. This interface, a little pink box called €Sense, has built-in sensors for light, temperature and sound. Also an external temperature sensor is provided. The interface takes it power from the USB-connector, to avoid batteries and power supplies. The design looks friendly and not too technical.

During the last decade we experienced with the use of Coach in Primary schools, as well in The Netherlands as well in international contexts (f.i. Pollen Project). First with a more complex interface. Later on with the €Sense.

Based on these experiences activity books with Coach activities have been developed with many examples for the different sensors of €Sense. The interactive poster presentation aims participants will become familiar with the interface and the teaching materials including Coach activities.



EXPLORING MARINE ECOSYSTEMS WITH ELEMENTARY STUDENTS: A SUCCESSFUL JOURNEY

Cláudia Faria, Raquel Gaspar,
Cátia Santos
cbfaria@ie.ul.pt

Abstract. The skills needed for a citizen of the 21st century are based on critical thinking and problem solving capacities, on effective communication, on collaboration, on creativity and innovation. Aligned with this, there has been a recent trend across the EU towards competence-based teaching with significant changes in science school curricula, and science teachers are at the heart of this process. These changes involve more engaging cross-curriculum approaches emphasizing the development of different kinds of literacy, science knowledge and positive attitudes towards science as well as an increased use of “real-life” applications, providing appealing learning contexts. In this work we present a hands-on activity about marine ecology with 20 students (11-13 years old), implemented by a teacher who participated in an in-service teacher education program about IBSE. The main objective of the activity

was to lead students to explore contents from many curricular subjects through the study of the sea. As a contextualization task, students were challenged to compare the human and fish body systems. They were first asked to characterize a fish and to make a draw of it. The majority of the fish drawn had all the same format and many had no fins. Then, the conflict arises: are fish all like this? They visited a fish market, where they could observe diverse fish, talk with vendors and discuss the reasons for the differences and similarities encountered. These observations were taken to classroom, where they discussed and systematized their learning. Moreover, they made a drawing by observation of a specimen brought, taking care to record its real characteristics and discussing the importance of doing that. Finally, they dissected the specimen and observed their internal organs. They also explored other curricular subjects, like symmetry aspects in fish body forms and research about different sounds in the sea. They were also asked to do a research about the Portuguese discoveries, including the interpretation and illustration of some episodes of a Portuguese poet book about the discoveries. Finally, they created a poster to present their findings to the community. As a final evaluation, the teacher referred not only students' acquisition of scientific knowledge, but specially their motivation, joy and engagement throughout the work. In her reflexion, she stated that the participation in the training program has changed her practices, helping her to foster students' love for learning sciences. She began to develop more hands-on activities based on students' experience and direct observations of the real world. According to her, these new practices resulted not only in successful students' acquisition of scientific concepts, but also allowed them to understand their surroundings through their critical reasoning. This type of teaching has profound implications for the competencies which teachers themselves need to acquire to effectively teach 21st century skills, requiring teachers to be high-level knowledge workers who constantly advance their professional knowledge, being capable of combining different approaches, to work in collaborative ways and to reflect on their practices. The question that arises is what teachers need to assist them in this demanding task.



INQUIRY-BASED LEARNING FOCUSED ON WATER FREEZING

Marek Balážovič, Boris Tomášik
balazovicm@gmail.com

Abstract. We introduce the method of the inquiry-based Physics lectures focused on water freezing. This kind of learning can be used in the class, but it may also be carried out by students in individual exploring, or in their extracurricular activities. Inquiry-based teaching and learning is used as a process in which teachers try to develop the students' abilities of critical thinking, along with deepening the students' understanding of phenomena around us. A teacher leads a student to the observation of a phenomenon and subsequently the student gets in front of some basic research questions and tasks, which can represent his research problem. Inquiry based learning stresses science process skill development and nurtures the habits of mind necessary to think like a scientist. Water is the most common liquid in the world. However, it has a lot of anomalies and particularities, which allow it to become a subject of inquiring. We present parts of inquiry-based learning in which we incorporate our topic - water freezing.



ALTERNATIVE PUPIL'S CONCEPTIONS ABOUT PHOTOSYNTHESIS AND PLANT RESPIRATION BY PUPILS OF 6TH GRADE OF LOWER SECONDARY SCHOOL

Katerina Svandova
katkasvandova@gmail.com

Abstract. The study is focused on the investigation of common alternative conceptions of lower secondary school pupils in 6th grade regarding to photosynthesis and plant respiration. These are abstract concepts and prove to be hard acquirable terms, not only for pupils. In this study alternative pupil's conceptions are understood as children's

conceptions, misconceptions or misunderstanding. People often hold alternative conceptions about natural phenomena for the whole life. To overcome alternative conceptions pupils must become aware of the scientific conceptions, the evidence that bears on the validity of their alternative conceptions and the scientific conceptions, and they must be able to generate the logical relationships among the evidence and alternative conceptions (Lawson, Thompson, 1988).

The main aim of the present study is to find out level of 6th grade pupils' alternative conceptions about photosynthesis and plant respiration with respect to gender and attitudes towards biology. One of methods how alternative conceptions are investigated is a two-tier test. It showed that great percentage of alternative conceptions in this area; particularly pupils' and students' did not understand photosynthesis and plant respiration as related, mutually connected physiological functions. In this study there was also used a two-tier test with nineteen items. The first part of every question in the test was focused on knowledge, the second part on the explanation of answer.

The sample size was compound of 6th grade lower secondary school pupils in the Czech Republic. The data were re-encoded in several ways, first by analysing the pupils' knowledge (from correct/incorrect answers), but also their alternative conceptions (frequency of occurrence of alternative conceptions). The 17 items regarding to attitudes towards biology was the part of the research tool, too.

The results showed that boys in 6th grade have bigger knowledge about photosynthesis and plant respiration in comparison with girls and they have fewer alternative conceptions than girls. Between groups of favourite subjects (science or non-science) was not found out differences. We can say that pupils have more knowledge in given topic with growing attitudes toward biology. The research showed that Czech pupils have a great percentage of alternative conceptions about photosynthesis and plant respiration. They particularly mistook photosynthesis for plant respiration, they thought that plant produced oxygen all over the day, the respiration took place only in leaves where are special organs – pores and the most important source of food for plants is water with dissolved mineral substances. One of ways how teachers could eliminate alternative conceptions is a graphic explanation of these concepts, correct

chemical clarification of photosynthesis and respiration and connection of information about these processes.

The study is one part of longitudinal research conducted in doctoral studies (the present part will be part of PhD. thesis of author).



SCIENTIFIC RESEARCH PROJECTS IN VOCATIONAL TRAINING SCHOOLS

Zita Esteves, Manuel F. M. Costa
zita.esteves@gmail.com

Abstract. Vocational courses are a resource for many students, with usually low motivation and high learning difficulties. Their curricula are of a more practical, experimental, and job oriented type, which requires teaching strategies less theoretical and focused on a more practical student involvement.

To this end, we propose the implementation of a teaching based on the elaboration of scientific research projects. A case study on two different schools, one as a public and the other as a private institution, is presented here. The involvement of students and their participation on a national science fair is carefully analysed.

Popularization of science in society

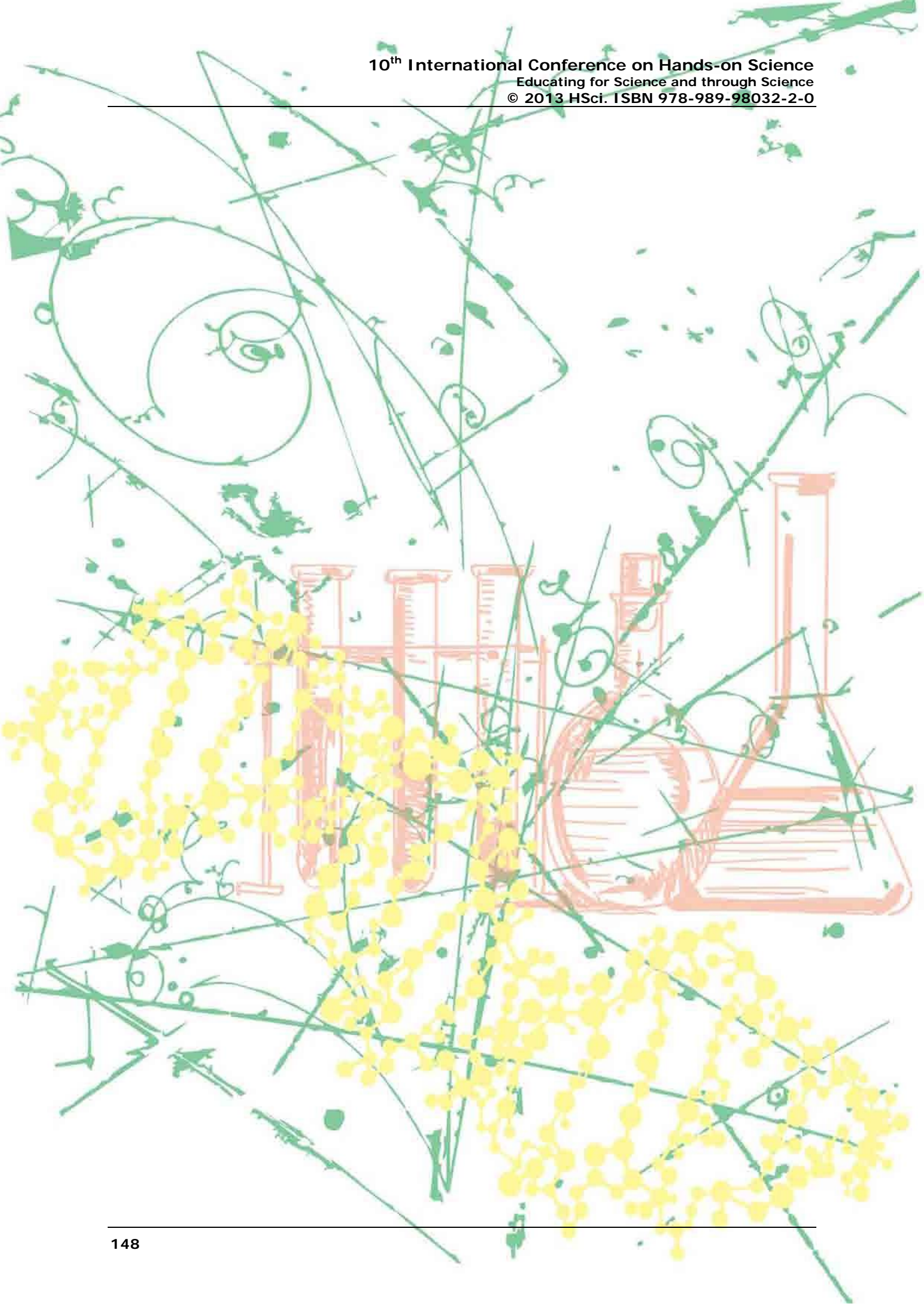

A SCIENCE ACTIVITY GUIDED BY CHILDREN AT PRE-SCHOOL LEVEL: FROM A STRING TO A PENDULUM

Maria de Fátima Sá Machado¹,
Marta Marques², Paulo Machado²,
Manuel F. M. Costa², Mário Almeida²

¹Colégio Teresiano, Braga, Portugal

²Centro de Física, Universidade do Minho,
Braga, Portugal.

fatima.sm@colegioteresianobraga.com

marta_marques@iol.pt,

machadopaulo@hotmail.com,

mfcosta@fisica.uminho.pt,

coimbra@fisica.uminho.pt

Abstract. *A challenge was made to a pre-school class for an activity about science seeking to find situations where children use creativity in the process of science learning at this age level. No previous suggestion was given about the method and way of implementing the activity. The teacher prepared in advance a set of diverse materials that could be eventually used in due course of the activity. The teacher would guide the activity to arrive to the concept of pendulum, but the way to reach that would be defined by the children themselves.*

The starting point was a simple string: to every child and the teacher was given a string of equal length. What could be done with such a string hanging in a hand was the first exercise. Immediately children's imagination and creativity was shown.

After a while a simple pendulum was under observation and some functioning problems were detected and later on debugged by the children, whose suggestions led the teacher hanging the pendulum at a door's lintel.

In this communication, we will report and on the experiment enhancing the pedagogical and educational merit of this type of approach and to highlight some creative findings of five year old children thinking about a physical phenomena.

Keywords. Creativity, pre-school, science teaching

1. Aims and motivation

The learning of sciences is a major concern in order to raise children fully integrated in a

technological society as we live in, improving their knowledge and skills in science and new technologies. The curiosity, imagination and creativity of children should be potentiated as early as possible, thus enabling them to feel comfortable and motivated when looking at and questioning natural phenomena, mathematical issues and modern technological devices.

This investigation was carried out in the context of a master thesis about creativity in the teaching/learning of sciences, from-pre-school to primary school, and we present the results obtained from a specific case among all the case studies.

Seeking to find children creativity in sciences at this level, a pre-school class was challenged to carry out an activity about science with no previous suggestion from the researchers about the theme, method and realisation of the activity. The challenge was accepted with enthusiasm.

The teacher's proposal was to drive an activity to build and to use a pendulum, but the way to get there would be guided by the children's inputs and suggestions. A set of diverse materials would be prepared in advance that could be eventually used in due course of the activity.

2. Instruments and methodology

Instruments

From a broader range of instruments used to record and to analyse the data collected, in this case we report only on the fieldnotes [1] and photographs [2] taken by the researchers and the interviews made to both the teacher [3] and some of the children [4] in the aftermath.

Methodology

The objective of the observation during this activity is to spot and to characterize at least three episodes of children creativity [5].

The notes taken include a time line [6] along which the observer records the development of the activity: the teacher's actions and speech, the children's interventions and comments, the actions taken and the events occurred. The latter processing of these field notes from different observers (actually 3), together with the pictures taken, enable to better identify and to characterize the quested creativity episodes.

The interviews include the observation by the teacher and the children of a sequence of pictures relative to one or more moments identified as

having creativity. Among other aspects, this aftermath step allows the researchers to inquire about the strategies of the teacher to stimulate the learning process, the affection involvement of teacher and children with each other and the perceptions of the children on their interventions and their progress on the learning activity.

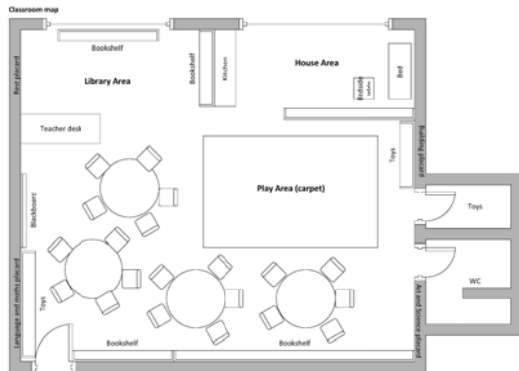

Figure 1. Classroom plan

3. Characterization of the class

The school, located in Braga, in northern Portugal, is a private educational catholic institution covering four levels of education: pre-school, primary school, 2nd and 3rd level of basic education; the students, in a total of 600, are aged between three to fifteen years old.

The class of this case has twenty two students (ten boys and twelve girls), with average age of 5 years old. There are no students with learning disabilities. The classroom is wide and bright with perfectly identified functional areas endowed with suitable materials (see Figure 1).

4. Activity and episodes

The aim of the activity is to build a pendulum (swing game) and study the factors that affect its motion (movement). Every child and the teacher had a string of equal length.

Children practice and develop the skills of systematic observation, questioning, planning and recording to obtain evidence, plan and execute an experiment whereby one variable is changed in order to obtain a certain result. Children work in a large group.

During the activity were identified three episodes of children creativity, which are presented next.

4.1. Episode 1 - Swing game - String

The teacher decided to perform an activity related to the pendulum and its movement. She began by questioning and dialoguing with the students about the length of the string and its effects in the pendulum motion, “Which string should we use? A long one or a short one? If you want to make a swing (game), then you need a good swing. What is a good swing?”

Regarding aspects of the lesson that involved creativity she states that from the moment she started the activity with only one string wagged by everyone and asking children what would happen or what could be done, they argued and showed that it was possible to have multiple movements and they have concluded that the movement could be tilting to one side and the other, with rhythm, and they also came to the conclusion that something should be hanging at the end of the string, making it similar to a clock room, like the one at their grandparents’.

And from there, students began the discovery of the simple pendulum. They explored a possibility with a string holding an espresso capsule at one end, and they gave the suggestion where the pendulum could be mounted. The first attempt was not successful because it was hanging from the wall (see Figure 2) and therefore the pendulum was bumping against the wall. The expected effect wasn’t obtained and children suggested using the lintel of the door and then it was possible to realize exactly what was in their minds and what they expected to see (see Figure 3).

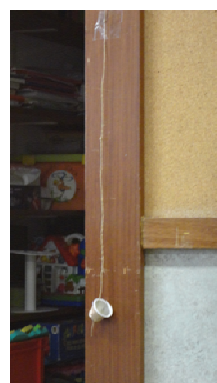

Figure 2. Pendulum hanging from the wall



Figure 3. Pendulum hanging from the door lintel

Science

At the beginning of the activity students weren’t fully aware that the foothold of the string will affect its motion. They start the activity by

exploring the string and making it to swing. After this short exploration phase, children are confronted with specific scientific problems concerning the swing game:

“If you want to make a swing game, then you need a good swing. What is a good swing? And what can be the rules for the game? How can you make such a game of your own?”, the teacher asked.

While the children are building, they are engaged in an inquiry activity. They want to build a swing which meets the expectations of the game they have in mind. In order to integrate the results of the inquiry into the game, children need to have the chance to do the research themselves. Children make observations, they question and then they plan and execute experiments testing their hypothesis. Children discover some principles of pendulum motion by executing experiments with the swing game.

Creativity

Creativity is present in the resolution of the problem by the students and registered in like: *“My grandmother pendulum clock has a swing like the one we are looking for.”*, which shows science process skills such as observing and describing the surrounding world. When the child was asked *“How can we build a swing like your grandmother has?”* she promptly answers: *“Attach the swing to the wall, hanging something at the end of the string.”*, showing imagination and problem solving skills.

Suggesting a potential way to extend the activity or to provide a solution to the problem/question also shows creativity, students were able to build the proposed swing, and fix it to the wall. When trying to make it swing they observe that *“This isn’t a swing! It hits the wall and doesn’t swing.”*. Many children tried to make it swing, unsuccessfully... so they reach a conclusion: *“The swing can’t be fixed in the wall, because it’s impossible to make it swing, hanging in there.”* This part of the activity shows that students were able to questioning, gathering evidence, interpreting evidence and communicating findings.

After the first trial of building a swing a child suggested *“Maybe we can fix it to the top of the door opening.”* So it was done, and the pendulum could swing at last.

4.2. Episode 2 - Swing game – Swing and hit

In this episode students discover some principles of swings by executing experiments with the swing game and develop the skills of systematic observation, questioning, planning and recording to obtain evidence.

Science

The teacher challenges: *“How can the pendulum tumble down these three plastic bottles?”*, Many children try to explain their ideas and put them in practice, mainly by trial and error. The teacher helps the children to test their hypothesis and to express their findings. She scaffolds the children to plan and execute an experiment whereby one variable is changed in order to obtain a certain result, *“Why are you putting the bottles closer?”*; *“What happens if the bottles are further away?”*; *“What happens if the string is small?”*.

Children have to find a way to solve these research questions by using the materials at their disposal such as a universal holder, several objects of different shapes and weights. From now on they are engaged into real inquiry to solve the questions.

Creativity

Students realize that if they attach the pendulum to the tripod, it moves more freely and as more pendulum like movement. They soon find the need to use a heavy object (they use an orange inside a plastic bag) to hang from the string (see Figure 4).



Figure 4. Final setup for tumbling down three bottles

Child M: *“We have to use a long rope, and we have to put the bottles closer, so that we can drop them of more easily.”*

The children build the swing. All elements come

now together: the swing, the weight, the bottles, and the place of the bottles. The children are working on the swing and are driven by the teacher questions.

So before the game can be played, the children have to think about some options on how they will have to build the swing. They also need to take into account the different playing rules that were put forward earlier, *child G*: “We have to bring the bottles closer to the pendulum.”, *child R*: “We have to pull the pendulum more backwards.”.

While students are busy, the teacher can observe and engage the children into inquiry (designing and running experiments and observations). Children plan and conduct investigations in order to collect data.

4.3. Episode 3 - Swing game – Full Bottles

The situation that gave this episode was proposed by teacher at the end of the activity in order to challenge students and to realize if they understand the contents involved in all the activity: “If one or two bottles are full of water how can you tumble them?”

Science

This situation was proposed for evaluation, so children can demonstrate understanding of concepts and/or ability to use inquiry skills. They used data collected/observed in the previous activities, to construct knowledge and to generate evidence.

Child M pulls the string further backwards, adding to the bag containing two oranges, a tangerine but only one bottle (of two) tumbled.

Child S: “The tangerine has less weight; we have to add to the bag something more “heavy”. We should use a wood block.”

[*Child S testing their hypothesis...*]

Child S was succeeded: the bag with two oranges, a tangerine and a wood block, was able to tumble the two bottles full of water (see Figure 5).

Creativity

Creative disposition, such as imagination and connection making, is observed like when Child J says: “If we use more objects inside the bag, heavy objects, easier it is to tumble the bottles.” Connection making is also observed when Child M states: “If we use a machine washer, all the bottles will also tumble.”

5. Summary and conclusions

The teacher initiated the activity promoting the interest and curiosity of students, presenting problematic situations and discussing with them. During the activity the teacher was always careful to drive the children in their learning, encouraging their trial and error attempts to solve the problems.



Figure 5. Two bottles down (only one is seen in the picture)

The children were learning in a large group and suggestions were always given by them. All the children of the group were given the opportunity to express their thoughts and expectations prior to the experiments. All those who had suggestions were allowed to talk to everyone and everyone respected the time for others to talk. Each and every one had the opportunity to experience all the pendulums built, so there was a social dimension, social interaction and collaboration among children.

As the teacher referred in the interview it is very important to listen to the children, to pay attention to their opinions, their issues, their proposals, and work from those, as we had the opportunity to observe, to make a walk of teaching and learning along the way.

The teacher feels encouraged and motivated because when children are making experiments they are inherently motivated and their imagination and creativity are requested and successfully applied to solve problems. Furthermore, motivation and affective development are important aspects of the

teacher's practice, as the play and learning are synonymous and children of this age do not distinguish between the two. This approach to play and exploration on children's interests allows them to follow their own lines of inquiry and create scientific understandings, alongside language development (including increasing vocabulary).

We would like to refer some items of this institution policy towards facilitating learning and development:

- planning activities that stimulate interest and curiosity in the children;
- providing support, scaffolding and allowing children to make their own learning decisions and solve problems in their own way;
- allowing the children to make decisions about the focus of their inquiry, even if that takes them away from the planned learning objectives;
- making connections between scientific concepts and phenomena, but not introducing scientific concepts artificially. Children are exploring their world and the teacher introduces new ideas or encourages further exploration when appropriate;
- reinforcing scientific concepts and vocabulary and thus supporting the development of the learning objectives.

It was a shot in the dark when we were compelled to find evidences of creativity in teaching sciences at pre-school level. So we had to look for an institution and teachers who could eventually join our quest. Surprisingly, the findings, a few of which we report in this paper, have overcome our best expectations.

Quoting what the teacher of this class said in the interview: *"I learnt to respect the opinion of my students and realize that there is a lot of potential and it's them who have to do the story, making the way and if they do this construction, that's great!"*

6. Acknowledgements

This work was supported by FEDER through the COMPETE Program and by the Portuguese Foundation for Science and Technology (FCT) in the framework of the Strategic Project PEST-C/FIS/UI607/2011

7. References

- [1] Newbury D, Diaries and fieldnotes in the research process, Research Issues in Art Design & Media. Birmingham: THE RESEARCH TRAINING INITIATIVE; 2001.
- [2] Einarsdottir I, Playschool in pictures: Children's photographs as a research method, Early Child Development and Care 2005; 175(6): 523-541.
- [3] Brenner ME, Interviewing in educational research. In: J. L. Green, G. Camilli & P. B. Elmore (Eds.), Handbook of complementary methods in education research (pp. 357-370). Mahwah, NJ: Erlbaum; 2006.
- [4] Danby SJ, Ewing L, Thorpe KJ, The novice researcher: Interviewing young children, Qualitative Enquiry 2011; 17(1): 74-84.
- [5] Siraj-Blatchford I, Sylva K, Muttock S, Gilden R, Bell D, Researching Effective Pedagogy in the Early Years. Department of Education and Skills Research Report RR 356. Norwich: DfES; 2002.
- [6] An example of fieldnotes using a timeline approach can be found here <http://cw.routledge.com/textbooks/9780415368780/D/ch182doc.asp> (Cohen et al. 2007).



PHYSICS OUTREACH AT THE UNIVERSITY OF RZESZOW

Malgorzata Pociask-Bialy¹,
Iryna Berezovska²,
Krzysztof Golec-Biernat³

¹Center for Microelectronics and
Nanotechnology, University of Rzeszow,
Poland

²Department of Computer Science, Ternopil
National Technical University, Ukraine

³Institute of Nuclear Physics, Polish
Academy of Sciences, Krakow, Poland
pociask@univ.rzeszow.pl,
iberezof@gmail.com
golec@ifj.edu.pl

Abstract. *A long history of the science popularization has its roots in Europe during the Industrial Revolution period. However, each time places its own priority themes and objectives. While disseminating new knowledge is a fundamental responsibility for all scientists, physics is among several scientific disciplines that are particularly important to innovation.*

The University of Rzeszow has gained extensive experience in physics outreach targeted the school-age students and general public. The results of FENIKS projects and its early impacts are summarized to evaluate its overall efficiency.

This paper outlines the Children University, which is the most current outreach project at the University of Rzeszow, describes its educational opportunities, short-term and overall goals and provides examples of students' activities.

Keywords. Physics, science popularization, education outreach, nanotechnology, secondary education, student contest, hands-on learning through games and activities, demonstration of physics experiments.

1. Introduction

To express a sense of urgency about translating science to those outside of the academy, we would like to quote Alan Leshner, CEO of the American Association for the Advancement of Science: "If science is going to fully serve its societal mission in the future, we need to both encourage and equip the next generation of scientists to effectively engage with the broader society in which we work and live".

While translating and disseminating new knowledge is a fundamental responsibility for all scientists, physics is among several scientific disciplines that are particularly important to innovation.

2. The beginning: under the umbrella of Polish Physical Society

In 1997-2009, Rzeszow Chapter of the Polish Physical Society (RCPPS) managed and guided scientists' outreach activities at the University of Rzeszow (UR). UR faculty members were engaged in some types of outreach that involved school-aged children.

2.1. Physics contests and science fairs for high school students

Competitions among high school students for the best paper on one of several topics in physics were organized every two years.

IV Regional Competition in 2005 is only one, but representative example. High school students submitted 121 contributions in three categories: (1) Research in physics; (2) Physics in poetry, religion, music and other fields; (3) a Poster presenting the World Year of Physics 2005 or a 2006 calendar.

Most of research contributions were essentially hands-on experiments. There were original and creative works in each category:

„Determining the density of a hen's egg" (Maria Marganska, Middle School # 6 in Przemysl, Grade 1);

“Einstein's Dream”, a song (SIDHE band, Lancut High School #1);

“Solar eclipse in Pharaon by Boleslaw Prus” (Pawel Olbrycht, Hotel School in Iwonicz Zdroj).

Maria Marganska's experiment deserves more attention for its originality.

In brief, the experiment was designed to measure the egg density using objects of everyday life. The Competition Board was overwhelmed that the student did very professionally in discussing the findings and determining the accuracy of the results. This project was awarded the Grand Prix.

2.2. The World Year of Physics 2005

Physics demonstrations (Fig.1) became the most widely used type of outreach in the World Year of Physics 2005 [1].



Figure 1. *Electricity demonstration organized by RCPPS at UR on May 18, 2005*

Thus, nearly 3000 people attended experimental demonstrations on thermodynamics, electromagnetism and optics on June 20 – 22, 2005.

Many outreach efforts focused on mathematics and physics contests and science fairs for high school students in small communities.

Giving open lectures was another way that continues targeting the general public after the World Year of Physics 2005 (Fig. 2).

Lecturers managed to find a usual ways to address the fundamental concepts in physics through discovering its relation with arts. For instance, Prof. Zielinski (Institute of Nuclear Physics, Polish Academy of Sciences, Krakow) delivered a presentation titled “Symmetry in Science and Arts” and illustrated his ideas by singing and playing many music pieces on piano.



Figure 2. *Open lecture about the Sun potentials and photovoltaics organized by RCPPS at UR on May 31, 2006*

3. Project FENIKS

In 2009-2012, the consortium of three universities (Jagiellonian University, University

of Rzeszow and Jan Kochanowski University in Kielce) implemented a 3-year project titled FENIKS within the Human Capital Operational Programme supported through the European Social Fund. Professor Krzysztof Golec-Biernat was a FENIKS coordinator at UR.

3.1. Types of science outreach

The high school students and teachers were engaged in different types of science outreach:

1. In-service workshops for high school teachers to introduce them in hands-on strategies used in physics teaching accordingly to FENIKS motto “Understanding through doing”.

2. Extracurricular classes taught by physics teachers at schools in 10 student groups, 2 hours per week. These classes were supported with instructional materials provided via FENIKS website. Students learned how to simulate physics phenomena and apply mathematics in solving practical physics problems. They were encouraged to develop hands-on projects in school laboratories.

3. Presentations delivered by the UR faculty members at schools. 10 presentations were delivered in each semester during 3 project years in educational settings of two types: middle schools and high schools. Topics of such activities were selected by schools according to their educational needs. Some of the experiments were requested because they are too much complicated to be performed by students themselves. Other ones required the equipment, which was not available at schools, and UR visitors brought along necessary items.

A great success featured the lectures titled „Black holes”, “The future and the end of the Universe”, “Time and space”, “Cosmic Collision”, “Unusual microcosm”, “Beautiful pressure in several scenes”, “Fascination with liquid nitrogen”. Dr. Rafał Hakalla and Dr. Wojciech Szajna, UR faculty members, delivered these lectures to the youth audience. Feniks hands-on shows are presented in two 1.5-hour movies.

Totally, there were 500 visits to deliver physics presentations at participating schools. The lectures and demonstrations were centered on experimental illustrating fundamental physics laws. The same experiments can be re-used in teaching mechanics, optics and electromagnetism to 1-2 year students majoring in Physics and Technical Physics at the UR School of

Mathematics and Natural Sciences.

To ensure further hands-on physics, the participating schools were supplied with many experimental facilities.

4. Hands-on experiments at the UR laboratories (Fig. 3). This type of outreach tended to combine science and practice.



Figure 3. *Laboratory exercises at the Electronics laboratory (UR Physics Institute)*

While visiting the University of Rzeszow, high school students attended 2-hour lectures delivered by UR professors and proceeded to 3 hour experimenting at UR laboratories under supervision of UR teaching staff (Fig. 4).



Figure 4. *A wind power plant at the CoachLabII Laboratory of computer-assisted experiments*

These hands-on activities were individual or in 2-student groups (Fig. 5). The educational focus was placed on everyday physics and experimenting with things that we use in the daily world.



Figure 5. *Representation of colours at the Laboratory of physics education*

5. Lectures and laboratory work were followed by contests of students' research projects. In each school, FENIKS participants submitted their projects to a school contest, and a school board selected the best project to represent the school at the competitions organized by UR.

6. Summer and winter science camps located in Zwierzyniec and Polanczyk/Myczkow. A typical camp schedule included both educational and recreational activities. Instructional materials were disseminated via FENIKS educational portal [2]. All related data is displayed at the UR Physics Institute website [3] in the FENIKS section. This portal greatly contributed in establishing Liga Fizyczna – Physics League, an Internet-based community of high school students interested in advanced learning physics.

3.2. FENIKS Summary

The UR target audience comprised 800 students from 80 schools in Podkarpacie. Totally, FENIKS involved 380 high school and university teachers as well as 6419 students. They completed project evaluation questionnaires and expressed a high level of satisfaction with their participation and achieved learning outcomes. Since FENIKS was finished only in 2012, its long-time impact can be evaluated a little later, though some positive signs appear now.

For instance, Maria Marganska, the 2005 Contest winner, and Robert Kopecki (Middle School # 3 in Rzeszow, Grade 3), the 2005 3rd Prize for exploring the phenomenon of forced birefringence in polarized light, are studying the sciences now. Robert masters Physics and Technical Physics in particular at UR, and Maria

became a student of Krakow Polytechnics (Poland).

4. The Children University

Opening the Center for Microelectronics and Nanotechnology and the Center for Innovation and Technical-Nature Knowledge Transfer has attracted much attention to communicating science and nanotechnology especially and stimulated the Children University (Maly Uniwersytet Rzeszowski), a new outreach project.

4.1. Outreach goals and opportunities

The Children University was opened on May 23, 2013.

Eleven departments of UR will organize 1 day classes for children once a month. These activities include practice, seminars, laboratory exercises, workshops and lectures; they will begin in the 2013-2014 academic year. To avoid interfering with regular school classes on weekdays, UR-based classes are scheduled on Saturdays only. Supervisors will accompany children to UR.

During lectures, moderators will assist the teachers to encourage the youngsters to take an active role in a lecture and to co-operate in delivering the lecture. Other outreach activities will be carried out by UR instructors in small groups to ensure high individual motivation in each student. These activities are planned to be informal events, a kind of family picnics, to stimulate kids' interest in science.

The new project places equal emphasis on both the process of science and the facts of science. Its scope is rather novel, beginning with laboratory-based short courses in environmental issues, alternative energy sources, lasers and optics supported with background scientific lectures and the Center facility tours

4.2. Laboratory of alternative energy sources

In 2010, the Laboratory of alternative energy sources was established at the Center for Innovation and Technical-Nature Knowledge Transfer. It is equipped with both sophisticated professional research facilities and instructional measuring stands to determine the performance characteristics of hybrid systems like a photovoltaic module and a windmill, a solar

module and a hydrogen cell; also there are spectrometers to determine the spectral and lighting characteristics of energy efficient light sources, etc.



Figure 6. *Wind energy: models of wind actuators at the Laboratory of alternative energy sources*



Figure 7. *Water energy: a model of a pumped-storage hydroelectric power station. The turbine is made of ladles*



Figure 8. *Transformation of solar energy: left - flat plate solar collector; right - a photovoltaic module made of solar cells of garden lamps*

Students themselves produced the first measuring stand for this laboratory, and within two years the students created a true laboratory. Third-year students studying Technical Physics with a special focus on Environmental Physical Engineering take a special practical course in this student-made laboratory. All experimental units at the laboratory (for example, Fig. 6) are students' diploma projects supervised by

Malgorzata Pociask-Bialy.

The model of a pumped-storage hydroelectric power station (Fig. 7) and the flat plate solar collector (Fig. 8) have been upgraded many times.

5. Conclusions

Science popularization must be linked intimately to the development and dissemination of appropriate technologies.

University-supported summer and winter science courses for high-school students and “the scientists in the classroom” outreach model are certainly not a new idea. What is unique about FENIKS and the Children University is not only their initial appeal to youth from both urban and rural school systems, but also their ability to engage students in a multiyear commitment rather than for just a single event.

6. References

- [1] Polskie Towarzystwo Fizyczne Oddział Rzeszowski. ROK FIZYKI 2005. <http://www.if.univ.rzeszow.pl/~orzptf/> [visited 18-May-2013].
- [2] FENIKS educational multimedia portal. <http://feniks.ujk.edu.pl/> [visited 18-May-2013].
- [3] Physics Institute of the University of Rzeszow. <http://www.if.univ.rzeszow.pl>



CORRESPONDENCE MATHEMATICAL SEMINARS AS A FORM OF INCREASING OF KNOWLEDGE POTENTIAL

Róbert Hajduk

*Institute of Mathematics, Faculty of Science,
P. J. Šafárik University, Košice, Slovakia
robert.hajduk@upjs.sk, hajduk@strom.sk*

Abstract. *Correspondence math seminars have a long tradition in educating mathematically gifted pupils in Slovakia and the Czech Republic. They provide a suitable, alternative form of education leading to improvement of the pupils interested in mathematics. Nowadays, to develop his talent, a student needs stable stimuli which*

will develop his curiosity and desire for new knowledge. Moreover, help him develop his talents and interests.

The basis of the correspondence mathematical seminar is motivation and creativity. Based on that it is possible to stimulate student's interest in the problems that are presented to him. It is a form in which student receives problems to solve that is the basis of the seminar. Seminars for elementary schools have tasks incorporated into the story, which increases children's interest in the tasks. Seminars for high schools have tasks formulate in mathematical language, but they are presented in such way that students use creativity to solve them and find creative solutions which lead to gradual discovery of new knowledge.

Keywords. Free-time activity, gifted pupils, popularization of mathematics, motivation, non-formal education

1. Introduction

The teaching process is set at the level of the average student. Consequently, the teacher is not able to deal with students who are interested to know more, beyond the curriculum of the subject. It is necessary to offer young people viable alternatives to meaningful spending of free time. During adolescence, young people begin to think realistically about their future. It is the development of their interests that can help them to do activities in the future that caught their interest early in life. A talented young person therefore needs incentives to develop their interests and therefore looks for opportunities outside of school. Young person enjoys the math and understands it, is at best admired for their talent, at worst is considered an outsider because he likes what most of the society does not. Full development of talent young person's talents is subject to comprehensive development of personality. This can be done using the natural desire of young people for physical, mental and social development of personality. One of the ways to encourage student talent for mathematics is mathematical correspondence seminar.

2. History of mathematical seminars

The idea of popularizing mathematics dates back to the 70th last century, when it was organized in 1976 the first mathematical camp called "Camp

for young mathematicians." This camp was based on the then new pedagogical and psychological principles developed by Vít Hejný - school teacher from Martin. The camp was the basis for the development of mathematics seminar with correspondent acronym KMS (Correspondence mathematics seminar). The founders of the seminar were Gavalec Martin et al. The main characteristic of the seminar was that it was based on a experiments and discoveries in mathematics made by students themselves, using mathematical games and collective competitiveness. In the next years, correspondence seminars for secondary school students were created in Prague, Bratislava and other cities. Later the seminars for younger students were created as well.

Currently in Slovakia there are several of mathematical correspondent seminars operating in Košice, Žilina and Bratislava.

The Faculty of Science, P. J. Šafarik University in Kosice, in collaboration with the STROM Association organizes three correspondence math seminars for different age groups:

- Malynár [2] – intended for students 4th - 6th year of primary school and the 1st class of eight year secondary schools,
- Matik [3] – intended for students 7th - 9th year of primary school and the 2nd, 3rd and 4th class of eight year secondary schools,
- STROM [4] – intended for students 1st – 4th year of high schools and last four years of eight year secondary schools.

During its existence the oldest correspondence seminar prepared 250 series of mathematical problems (comprising an average of 6 problems), corrected about 200,000 solutions. Seminar organized more than 80 camps for the best solvers. In the past 3 camps per year and at present 2 per year. At the present each seminar involves 40-90 participants.

3. Correspondence mathematical seminar

Correspondence mathematical seminar consists of two complementary components [1]:

- Correspondence section that leads participants to solving of mathematical problems regularly.
- Week camp, which is primarily motivational and through personal contact creates a community of people

with similar interests.

During the school year correspondence math seminar consists of two separate semesters and each semester consists of two series of mathematical problems. Each series contains 6 problems which students have to solve up to some predetermined time. Students write problem solutions on paper as in Mathematical Olympiad. A student can write a partial solution of the task, describe an incomplete solution, if at some point he cannot move forward. Written solutions to send to our address by post, or sent via e-mail. It takes about 2 weeks for the solutions to be corrected. Moreover solutions get commented on. Corrected solutions are students returned to the school along with a magazine containing the order of solvers, and the sample solutions to individual mathematical problems. Each series contains problems that go beyond the curriculum and therefore require independent thinking, a deeper interest in the subject and sometimes study of mathematical literature.

An important part of the seminar is a 5-day camp for the best solvers of the correspondence part of the seminar. Each camp consists of two parts

- Professional - it consists of lectures to extend mathematical knowledge of students. Lectures are conducted in small groups, which provide space for questions; a lecturer is allowed access to individual students. Sometimes lectures also lectured by external teachers from university who are dedicated and devoted to gifted students
- Entertainment - it consists of various competitions and games that are designed not only for mathematics and the development of general intelligence, but also the sports activities.

Camps are the source of new information for participants, knowledge from different spheres of life. Sometimes students work in groups where they learn to cooperate, and sometimes the games are designed to develop their own individuality. Participants are lead to thinking rationally in any situation, to learn what their responsibilities, rights and opportunities in life are. They also touch the issue of the scale of values, ie the status of friendship, family, a variety of adverse effects or money in life.

3.1. Significance of correspondence math seminar for students

Correspondence math seminar with its mission fills teaching process of gifted student. Nowadays, to develop his talent, a student needs stable stimuli which will develop his curiosity and desire for new knowledge. This is primary mission of correspondence seminars, but not one. Moreover, correspondence math seminar:

- develop verbal skills by formulate their ideas in solving mathematical problems of math seminar,
- develop logical thinking and leads to find logical order in solving mathematical problems,
- leads to development of patience, because solving of mathematical problems often take very long time,
- learn to organize your time to study,
- provides the appropriate form of meaningful use of leisure time,
- Give the possibility to find friends with similar interests. It helps them to integrate into society at the time of adolescence

Correspondence form of seminar has the advantage that the student has some period of time to solve previously assigned math problems. It is a great advantage, because tasks are often designed so that the process of solving them requires thinking, testing and the gradual discovery leading to the solution. Acquired skill high school students can develop, and they are good tools for building future career. Students, who solve correspondence mathematical seminars after end of high school, are often top students of mathematics, physics and informatics. Several of them continue to study medicine, law or management. The experience and skills acquired by solving of math problems are very useful for them, and they use it in further studies.

3.2. Significance of math seminar for organizers

Several of high school students are organizers of math seminars for Youngers students. For high school students correspondence math seminar gives more opportunities to develop his personality. Due to the fact that as a student primary and secondary school solved math

seminar, on high school they wants to be the organizer of math seminar for primary or secondary school [5]. Organization of the seminar leads to non-formal education of students.

For students who organize seminar for younger students' correspondence math seminar:

- Develop their communication skills. As a person who revises student's solutions, they have to correctly, accurately and objectively reflect and formulate your comments. Because their comments are used on communication with the student whose solution is revised,
- Develop teamwork. As an organizer of seminar, they have to be able to work in a team, be able to accept and fulfill the assigned tasks on time and with the required quality,
- Develop organizational skills. As an organizer is responsible for ensuring of assigned activities. For example: organization of the revision process one series of math problems, organizing of math camp or one-day competition.
- Learns to independence and responsibility in deciding what they do.

High school is gradually gaining valuable experiences and skills. From own experience, as well as from the reactions of last and current high school students, we know that the received experience and skills can applied in further studies. Further in his personal and professional life, too. Several of them after end of high school continue as a volunteer to organize activities in all three math seminars. But, it is not a necessary that their activities had to be directly oriented on mathematical seminars. They can organize seminars related to physics or computer science, or they are dedicate to work in other spheres of life.

4. Sample of story in Malynár

Motivating factor in mathematical seminars lies in the formulation of the problem. For the primary and secondary school students is motivating planting of problems in a story written or drawn by the organizers of correspondence seminar. Students are lead to problem solving by searching for treasures, traveling in time to save the world and living the adventure with the heroes of the story. Now we

show the sample of story in math seminar “Malynár [2]” with mathematical problems.

...Meanwhile, captain Beenthere sat in his quarters with narrowed eyes thinking about a problem given to him by the scholar Speculator.

Problem no. 2: On his table the captain has a laid out set of cards each one black on one side and white on the other. Every nautical second he can flip two adjacent cards sharing a rim. Can he use this method so that they all end up with the black side facing up if they start out as shown in the picture? If yes, at least how many nautical seconds does he need?

The captain was suddenly interrupted by someone knocking on the door and he quickly swept the cards aside. The youngest crewmember peered carefully into the quarters. Jacob disliked speaking with the captain at close range and due to this the captain considered him a very shy sailor. His deck washing skills on the other hand were perfect.

“We’ve found the journal of your grandfather, captain. Mister Speculator has already started with the translation,” he informed and then hastily retreated.

“I’M GLAD TO HEAR THAT!” Beenthere shouted after him. The captain grew up in a very busy district and never really learned how to speak normally. Jacob still hadn’t quite gotten used to it. The worst part was that the captain sometimes talked in his sleep. “OH, I ALSO FORGOT TO TELL YOU IN THE MORNING THAT YOU’VE RECEIVED THE COOK’S POSITION! WE’VE SOMEHOW FORGOTTEN THE OLD ONE ON THE PREVIOUS ISLAND ALONG WITH SOME OTHER MEN!” The captain gave him a broad smile. “WELL CHOP-CHOP, IN THE KITCHEN YOU GO, LUNCH IS SOON!”

Splinter gave a salute and grumpily ran down into the sub-deck. He had hoped to rest a little after all that digging. He read the manual on a box of risotto and found out that he needs a liter of water.

Problem no. 3: There are three containers on a ship: a green one that has 8 liters of volume, a red one with 5 liters and a blue one with 3 liters. Currently the green one contains 5 liters of water, the red one contains 3 liters and the blue one 2 liters. How should a sailor proceed in this situation if just by pouring from one container into another he wants:

- a) The green one to contain exactly 1 liter
- b) The red one to contain exactly 1 liter

- c) The blue one to contain exactly 1 liter

He cannot spill the water out and the containers are not see-through. Are all tasks possible with at most 2 pourings?

Meanwhile Speculator was on the deck steadfastly resolving the old journal word after word. It was written entirely in a tidy scrawl in a long dead language so it was no easy job. The monk Speculator’s real name was Bohush, but the name did not sound wise nor mysterious thus he made up a new one. Finally he came upon a mention of the Golden Rose. After a hundred pages of ‘how to correctly fold a sail’ and ‘where can you buy the best anchors’ Bohush was already convinced that the journal was useless. But there it was in dry ink on ancient paper. Aurium Rosé. The Golden Rose. He set out to translate with newborn passion and hope that it won’t just turn out to be the name of some rudder store.

Meanwhile, the ship approached a new island.

“Land ahoy!” shouted Sindigud, the ship’s first officer as he nimbly jumped off the ship’s yard.

“Risotto!” Jacob called out while staggering up the stairs with a giant cauldron. The land was inhabited and it even had a port so right after eating they set out to replenish their supplies. The scholar Speculator needed new ink, the captain left to go looking for new potential sailors, Gilliver had to go buy food and Jacob was left to wash the dishes from lunch. Sindigud intended to train somersaulting into the ocean at first, but he quickly changed his mind in favor of buying a saber. He vigorously jumped down onto the pier and started jogging while he looked around for a one-hand weapon stand. He stopped only after his forearm was grabbed by a bony arm. It belonged to an old woman with a crazy look on her face.

“A storm is coming!” She shouted in his face.

“Do not fear fighting in the water! Watch out for the feathered ones!” She released him.

“I would trust her,” a carpet saleswoman advised the baffled Sindigud from across the street. “She tends to be right. For example, last time:

Problem no. 4: The oracle uttered 5 forecasts before the last football matchup between The North and The South:

- a) It will not be a draw
- b) South will concede a goal
- c) North will win
- d) North will not lose
- e) Exactly three goals will be scored in the match

After the match it turned out that only three forecasts were correct. How did the match end?

5. Other activities of math seminars

Mathematical competitions are a good extension of mathematical seminars. They are open for a larger group of people, and their main aim is to offer mathematics to the widest possible group of students. In Kosice are organized four such competitions per year. Form each of them is different, but joint them fact. Namely that on one place in a same time is on each 200-250 students which are trying to solve mathematical problems. One of those competitions has an international dimension and is organized together with three universities in the Czech Republic and Slovakia. On this competition (called "NABOJ [6]") participates in about 1 500 students. These mathematical competitions are good for promoting of our seminars and popularization of mathematics.

6. Conclusion

Systematic work with students who demonstrate an interest in mathematics and computer science has a long tradition in Slovakia. Described activities cover the age group of students from 4th year of primary school to 4th year of high school. Sense of these activities confirms the success of students in various competitions as well as the application these students in real life.

7. Acknowledgements

Activities of correspondence mathematical seminars Malynár, Matik and STROM and training courses of organizers of correspondence mathematical seminars are supported by the grant APVV LPP-0057-09 Developing talent through correspondence seminars and competitions.

8. References

- [1] Gavalec M, Mihók P, Mihalíková B. Correspondence math seminar,, Krajský dom pionierov a mládeže v Košiciach, 1986. [in Slovak]
- [2] Malynár – Correspondence math seminar, The STROM association, Univerzity of P. J. Šafárik, Faculty of Science, 1990. <http://malynar.strom.sk/> [visited 15-May-2013]
- [3] Matik – Correspondence math seminar, The STROM association, Univerzity of P. J. Šafárik, Faculty of Science, 1986. <http://matik.strom.sk/> [visited 15-May-2013]
- [4] STROM – Correspondence math seminar, The STROM association, Univerzity of P. J. Šafárik, Faculty of Science, 1976. <http://seminar.strom.sk/>
- [5] Hajduk R. Rozvíjanie talentu prostredníctvom korešpondenčných seminárov a súťaží. In: Zborník príspevkov z IV. odbornej konferencie Quo vadis vzdelávanie k vede a technike na stredných školách. Bratislava: Mladí vedci, 2011. p. 92-96. [in Slovak]
- [6] NABOJ – International math competition. <http://naboj.org/en/>



ONE EXAMPLE ON COMBINATORICS

František Mošna

*Czech Univ. of Life Sciences Prague,
Czech Rep.
mosna@tf.czu.cz*

Abstract. *Good examples of applications of mathematics are very important for its popularization. Such examples are usually associated with some games and they use probability. This paper presents one example using graph. It deals with one card game and shows the process how students can find solutions.*

Keywords. Combinatorics, games, graphs, probability, problem solving.

1. Introduction

Mathematics used to be very unpopular subject at school. "What use is it of?" is a frequently asked question of pupils or students. They are convinced that maths is good just for student's testing and bothering. They consider maths only as an instrument for their suffering.

Demonstration of areas where it can be useful is one of the ways how to change such attitude of students. Good examples of maths application can bring a significant contribution to its

popularization.

2. Games and probability

Examples which are perceived as useful are usually associated with some games, (see [1]). Students like betting. They can use the results of such examples for their win. Such examples occur especially in probability.

2.1. Tossing fair number cubes

For instance, when tossing cubes, we are interested in occurrence of number six. How many cubes would be necessary to toss in order to obtain the probability greater than 50%? Students usually estimate 3 cubes. They are surprised that the correct answer is 4.

2.2. Which cube is better?

Or another one, inspired by [2].

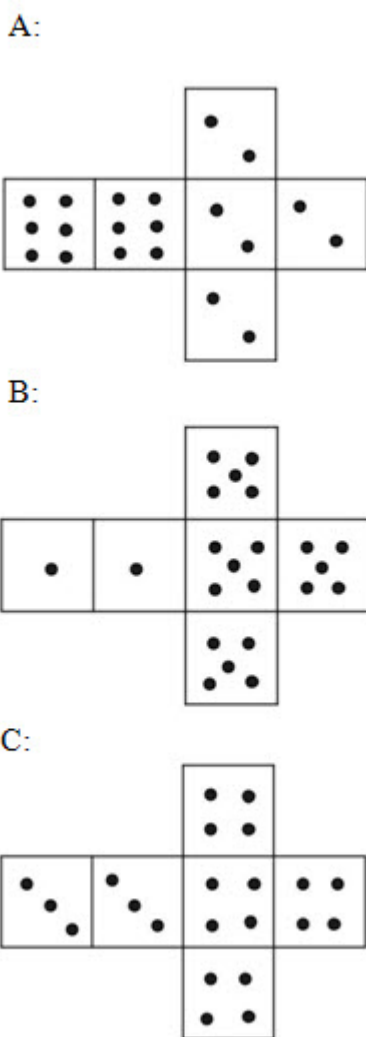

Figure 1. Number cubes A, B and C

Each of two players tosses one of three special number cubes A, B and C (see Fig. 1). He who reaches the greater number is a winner. Which cube is preferable to choose?

Students are surprised that the relation “to be better than” is not transitive in this situation. The real advantage is to let opponent to choose at first. The reason is clear after comparing all three couples of cubes. The cube A is better than B, the cube B is better than C and the cube C is better than A. Hence choice is a disadvantage.

3. Game with cards

In lessons of combinatorics, one student asked me about the following game. This game contains a certain number of cards with eight different figures. If we choose two of cards there exist just one figure which is displayed on both cards. How many such cards can be created? (Student stated the number 55 at first.)

The number of such cards can be infinite. But if we additionally assume that any figure is displayed at least on two cards, number of such cards must be finite. It means that there are no figure which could be displayed only on one card.

3.1. Solutions using graphs

For solving this problem, we use notions from the graph theory (non-oriented graphs without loops).

We denote by k the number of figures on one card and by n maximal possible number of cards. We would like to find the general dependence of n on k . Let the figures be represented by capital letters A, B etc. in the following text.

The case with 2 figures on a card ($k = 2$) is very simple. We have only cards \overline{AB} , \overline{AC} and \overline{BC} . The number of cards is $n = 3$ and a number of used figures is also 3.

Let us draw the situation for $k = 2$ to the graph, where each card is represented by a side of a triangle (see Fig. 2).

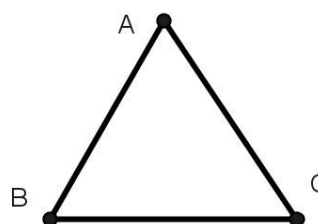

Figure 2. Triangle for $k=2$

For $k = 3$ the problem is easy, too. We have cards \overline{ABC} , \overline{ADE} , \overline{AFG} , \overline{BDF} , \overline{BEG} , \overline{CDG} and \overline{CEF} . The number of cards and the number of used figures is again the same $n=7$.

The situation for $k = 3$ is similar. It can be illustrated by a graph, where each card is represented by triangle in a heptagon (see Fig. 3).

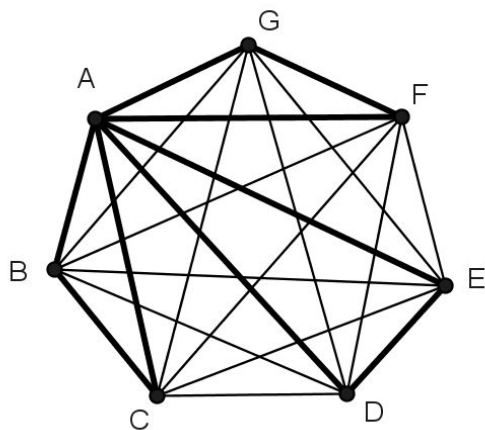

Figure 3. Heptagon for $k=3$

Similarly for $k = 4$ we have the number of cards and number of used figures equal to $n = 13$.

For $k = 4$ each card is represented by quadrilateral with its diagonals in the tridecagon. Hence we can generalize for k . Each card with k figures is represented by a complete graph with k vertices. Their number is n and they together compose the complete graph with n vertices.

The number of edges in the complete graph with n vertices must be n multiple of the complete graphs with k vertices. Hence it holds.

$$\binom{n}{2} = n \cdot \binom{k}{2}$$

and

$$\frac{n(n-1)}{2} = n \cdot \frac{k(k-1)}{2}$$

From that equation it could be obtained the relation

$$n - 1 = k(k - 1)$$

and final result

$$n = k^2 - k + 1.$$

The correct answer for $k = 8$ is $n = 57$, (not 55, the student was wrong).

3.2. Experience with students

This example presents typical process of problem solving in mathematics.

First students know neither answer nor the solving strategy for such “great“ number like 8.

In such situation they should be pointed to simplify a problem. They were suggested to reduce the number of figures. We have seen that to find correct solution of problem it would be very simple if $k = 2$. Even for $k = 3$ students tried to make up some strategy of step-by-step creating all required cards.

The most difficult task for students is to find relation between a number of cards (n) and the number of figures (k). The geometrical ability to see in mathematics is usually a mix of talent, endurance and stubbornness not to give up problems.

4. Problem solving

Solving of problems has a positive influence for getting good ideas. Students good in maths are usually good in other disciplines and fields of activities. This is significant advantage not only at school but also in the future carrier and in the life.

5. References

- [1] Jančařík A. Hry v matematice. Prague: Fac. of Education, Charles University; 2007.
- [2] Płocki A. Zvláštní matematické objekty, nástroje a postupy v počtu pravděpodobnosti. Matematika – fyzika – informatika 1998-9; 8(4-5): 193-201, 257-263.



INITIATING THE SCIENTIFIC METHOD, INITIATING YOUNG RESEARCHERS

Josep M. Fernández-Novell¹,
 Carme Zaragoza Domènech²

¹Department of Biochemistry and Molecular Biology, University of Barcelona.

²Open Institut of Catalonia (IOC).

Department of Education, Government of Catalonia.

Barcelona, Spain.

jmfernandeznovell@ub.edu

czaragoz@ioc.cat

Abstract. To improve learning physics on primary level it is indispensable to imagine different educational approaches focused on the progress of children’s understanding. For this,

some short and simple physics experiments were designed, about the weight of the air, the atmospheric pressure and the fall of things. Based on the fact that playing and discovering things (or some physics laws) are common in childhood. Our initiative is developed in primary school classrooms and also in the "openlab" from the Scientific Park of Barcelona (Parc Científic de Barcelona, PCR) where primary school classes come to attend the experiments.

Keywords. Primary school, science, physics, children, scientific method.

1. Introduction

In a previous work [1] they have analyzed the relationship between the present and the future of science and scientific studies with students of primary school level. It shows that about half of them want to study science. Of those who continue scientific studies two of three want to be medical doctors or biologists while the remaining third is divided equally between doing chemistry or physics.

No doubt these results seem to indicate good omens for future studies in the field of science but nothing is further from reality. The latest data presented by the Spanish Foundation for Science and Technology (FECYT) in 2010 [2] about the social interest in science and technology in Spanish society indicate that "only" 13.1 % of the interviewed people have any interest in science and technology. These results show a considerable ignorance about the importance of science in our society and it leads to the next question.

Why don't teach science at primary school level? The overwhelming response from teachers is "scientific method is not present in the science curriculum of Spanish primary school level [3-4]. According to their commitment to help increasing the knowledge of their students, primary school teachers say a resounding yes to teach science at primary level. But how do they raise the students' interest in science, in physics to be precise?

One point all teachers agree on is that "children love experiments". During EMBO's second international practical workshop for science teachers [5], Dean Madden exclaimed enthusiastically: "children love to get their hands dirty". And the simpler the experiment the better, it seems. Furthermore, a simple experiment done with minimal equipment in the school laboratory

must stimulate curiosity and interest to the children.

To encourage the interest in physics among these young people, children should be given the chance to change their previous wrong ideas by using experimentation. We have prepared and developed simple experiments about physical changes.

The aim is that primary school students understand and learn some about physics and scientific method [6]; in addition, all must be explained by a scientist, which is an important aid for teachers at this level. This strategy aims to bring scientific knowledge to the schools because science is with us daily. This is the message that this educational approach wants to give to young students

2. Methodology

The innovative approach presented in this article uses as a methodology previous educational contributions to present science, particularly physics, to children aged 8-9 years. This is to bring science laboratory to the classroom [7].

The simple experiments presented here take place in a positive atmosphere; and they are developed in groups [8] to increase their co-operational education. Our initiative is developed in primary school classrooms and also in the "openlab" from Scientific Park of Barcelona [9] (Parc Científic de Barcelona, PCR) in where primary school classes come to attend the experiments.

This new education strategy is based on finding simple everyday objects and materials as Maria Montessori [10] did. This strategy arouses scientific curiosity in students and which explain some basic concepts in general science. For example, [6, 11] show the Galileo thermometer which measures the temperature due to density differences.



Figure 1. It shows the "openlab" and the

preparation of session, lab coat on the chair, a pen and the experimental guide on the table.

then weigh again and write down this result in table 2.

Name:

Date:

School:

The scientific method

Working the air	Experimental part
What is atmospheric pressure?	Does air have weight?
The fall of things	Water Glass
	Which one will hit the floor first

Table 1. *Primary research*

Young students were given a lab coat, a guide with some definitions and questions about the experiments that they will do. Table 1 shows part of the guide and experiments: Working the air, what is atmospheric pressure? and, the fall of things.

3. Experimental approaches

In italics there are the definitions that children need to understand experiments.

Furthermore, young students' answers are also in italics.

3.1. The scientific method.

Scientists want to know what it is and how it all works, our bodies, the environment, space, etc. They get it using the scientific method.

"First scientists observe and then they make a hypothesis which will be proved or rejected by an experiment. If the hypothesis is confirmed they can formulate a theory"

The scientific method is the same reasoning that children have when they taste any new food, vegetables, fish, etc.

3.2. Working the air

What is air?

"Designate "air" to the mixture of the gases in the Earth's atmosphere. It consists mainly of: Nitrogen (78.1%), Oxygen (21%), Argon (0.9%), Water vapour (0-4%) and other gases (ppm)"

Does air have weight?

Young students answer usually is 'no'.

Experimental part

Each group of two students have to take an empty balloon and weigh it, record the result into the table 2.

They have to inflate the balloon and tie it up,



Fig. 2. *Weighing air.*

In table 2 you can see the results from two student groups. What is the meaning of two or more different results?

"It depends on each inflated balloon. However, the air actually does have weight."

	Weight (A group)	Weight (B group)
Empty balloon	1.32 g	1.32 g
inflated balloon	1.48 g	1.42 g

Table 2.

3.3. What is atmospheric pressure?

Otto von Guericke built the Magdeburg hemispheres, two hollow metal hemispheres of 500 L capacity that adjust perfectly to form a sphere. If you removed the interior all the air is "emptiness" and 16 (8 and 8) horses were unable to separate them.

What effect does atmospheric pressure have? *Students don't know* and teachers have to explain it. *"An example of pressure would be when we go skiing. If we are without skis we will sink in the snow but with skis we can glide over it because pressure is force per unit area. Air pressure is the force exerted by the weight of air as you have demonstrated before. Although air molecules are invisible, they still have weight and take up*

space. Atmospheric pressure is the weight of air above our surface.”

How do you measure atmospheric pressure? Children, very young students, don't know. “In the XVII Century, Evangelista Torricelli invented the barometer, an instrument to measure atmospheric pressure.”

(Units: atmosphere = 101325 Pa = 1013.25 hectopascals; 1 millibar = 100 Pa).

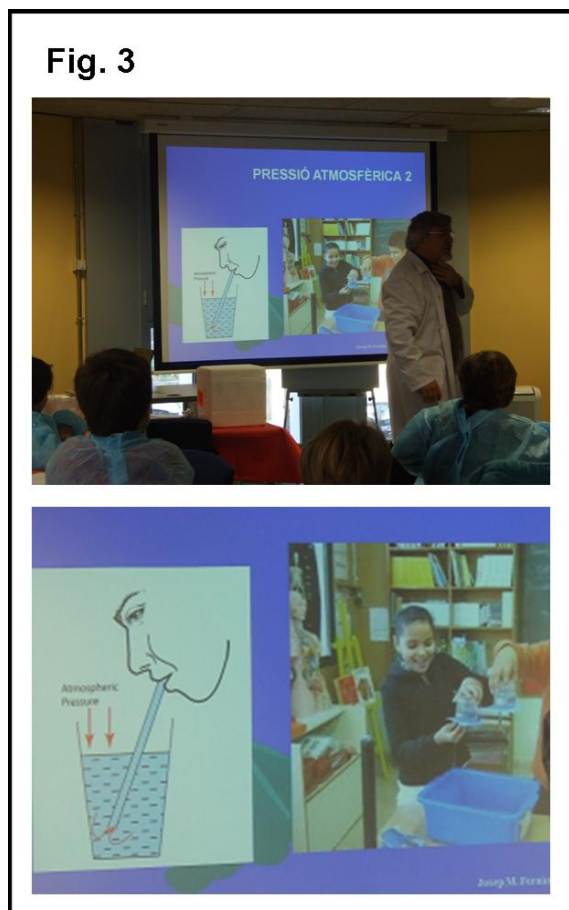

Fig. 3. Water glass example.

Experimental part

a) Take two suction pads together and squeeze them to remove the air between them.

Try to separate them. It is impossible. Why?

“We can not, we must do more strength.”

Now allow some air to come between the two suction pads. What happens? Why?

“It is easier open it, but why?”

The answer posed by teachers is “the pressure of the air.” If we want to separate them we only need to allow the air to re-enter the space between the suction pads.

b) Is the atmospheric pressure acting in all

directions?

The student's answer is “No, only vertically, from top to bottom.”

However, students can not separate the two suction pads although these are in vertical or horizontal position and even diagonally.

Water Glass. This simple experiment is for homework.

Completely fill a glass with water to the brim. Cover the opening with a card, a plastic or some other flat object. Hold the card in place, take the glass to the sink and turn it upside down. Remove your hand from underneath.

Eureka! Because the water inside the glass is lighter than the air outside, the card is held in place by the force from the air pushing up.

3.4. The fall of things

The first question related with the fall of things is: If you take a piece of paper and a pen and you let them both fall down which one hits the floor first? Children's answer “The pen, obviously.”

Why does the pen fall faster than a piece of paper? Their answer is “Because the pen is heavier than the paper.”

Sometimes, one student says “it is gravity.”

Teachers have to explain what gravity means. “It is some force that is pulling all of us “down”, it is invisible force that attracts any two objects found in the Universe, the Sun and the Earth, the Earth and the Moon, etc.”

These are the children's perceptions or preconceived thoughts. Now they have to do an experiment to prove if they are right or wrong:

Experimental part.

Children take a piece of paper and divide it into two equal parts. Which one is heavier? Their answer is “Both are of the same weight.”

Which one will hit the floor first, if we let both pieces of paper drop?

Few children answer “It depends on how we let them drop.” They have an open mind.

Which one will hit the floor first, if we let both pieces of paper drop the same way? Now children answer “Both at the same time.”

Now they have to make a ball of one of the pieces of paper and we ask the same question. Children answer “The ball will hit the floor first because it represents less resistance to air than the flat piece of paper.”

Certainly. But with this experiment students have rejected their previous idea that a heavier object

hits the floor before a lighter one as Galileo Galilei demonstrated in XVII Century experimenting in Pisa tower [12].

Another example that children can do at home is experimenting with two small spheres of exactly the same size, one made of iron and the other made of wood or plastic. If they let them drop they will see that both spheres hit the floor at the same time.



Fig. 4. Dropping pieces of paper

4. Conclusion

The primary school science teachers' perception about these experiences indicated its importance as a good educational tool.

This practice has contributed to:

- Increase primary school science teachers' implication to perform many experiments.
- Create new confidences between scientists and primary school science teachers.

For children this adventure has served to know that:

- Like all other substances, air also has weight
- The weight of air can be used to demonstrate air pressure and its effect on weather and the atmosphere.

Finally, it is not necessary to give a hard scientific explanation or name any physical laws because children come to the right conclusion on their own.

Acknowledgments.

We thank the teaching staff all primary schools who participated in this educational approach. We also thank Mr. Jordi Fernández for revising the English manuscript. This activity was supported by the Technical Section of Education from the College Teaching of Chemistry of Catalonia (CQC).

References.

- [1] Fernández-Novell JM, Zaragoza CA. Study of the perceptions and opinions of children and teenagers toward science in IATED ed. Proceedings of ICERI2011 Conference: 4th International Conference of Education, Research and Innovations; Nov 14-16; Madrid, Spain 2011, p. 3571-3576.
- [2] <http://icono.fecyt.es/> (02/05/2013)
- [3] <http://www.xtec.cat/web/curriculum/primaria> (05/05/2013)
- [4] <http://www.mec.es/educa/sistema-educativo> (05/05/2013)
- [5] Moore A. Breathing new life into biology classroom. EMBO Rep. 2003, 4 (8), p. 744-746.
- [6] Zaragoza Doménech C, Fernández-Novell JM. Teaching science with toys: toys and physics. Hands on science: Bridging the science and society gap. University of Crete; 2010. p. 63-68.

- [7] Fernández-Novell JM, Zaragoza C, Fernández-Zaragoza J. Chemistry Education: Children and Chemistry. In: Divjak S, editor. Proceedings of the International Conference on Hands on Science; 2011 Sep 15-17; Ljubljana, Slovenia. Ljubljana: University of Ljubljana; 2011. p. 5-15.
- [8] Dennick RG, Exley K. Teaching and learning in groups and teams. *Biochemical Education*; 1998, 26, 111-115.
- [9] <http://www.pcb.ub.edu> (10/04/2013)
<http://www.biografiasyvidas.com/biografia/m/montessori> (05/03/2013)
- [10] Riley P. Galileo. Observations, Experimentations and Inventions. Random House Mondadori (Editorial Montena). Barcelona. 2009.
- [11] <http://www.biografiasyvidas.com/monografia/galileo/> (18/04/2013)



PRACTICAL ACTIVITIES ON CHEMISTRY FOR YOUNG STUDENTS

Josep M. Fernández-Novell¹,
Carme Zaragoza Domènech²

¹Department of Biochemistry and Molecular Biology, University of Barcelona.

²Open Institut of Catalonia (IOC).

Department of Education, Government of Catalonia.

Barcelona, Spain.

jmfernandeznovell@ub.edu

czaragoz@ioc.cat

Abstract. *To help students, 11 to 14 years old, to understand the fantastic world they live in better, it is essential to encourage them to do and examine the results of chemical experiments as would a true scientist. Several experiments were designed and developed in primary and secondary school classrooms and also in the "openlab" from Scientific Park of Barcelona (Parc Científic de Barcelona, PCR) where school classes come to attend the experiments:*

Physical and chemical changes.

The states of matter.

Separation of mixtures.

Salt and water. Oil and water.

Acids and alkalis.

An "Indicator" from Red Cabbage.

Keywords. Primary, secondary school students, chemistry, science education.

1. Introduction

What is chemistry?

Chemistry can be defined as the study of matter and how that matter undergoes change. You are chemistry and chemistry is all around you; this explains from breathing, iron oxidation and the production of plastics and pharmaceuticals to protect the environment and the production of cosmetics and medical materials, for instance.

What is a chemical change?

A chemical change is when two substances (atoms or molecules) react together and it is produced a new substance different to previous ones with another chemical properties. Some examples of chemical changes include combustion (breathing and burning), cooking an egg, rusting of an iron pan and the reaction between the hydrochloric acid and the sodium hydroxide to produce salt and water.

A chemical change has occurred if:

- There is a formation of gas (fizzing or bubbling): The reaction of the kitchen marble (calcium carbonate) with acid such as vinegar or lemon juice.
- The reaction produces heat, light or odour: Special gels hot and cold and the smell of ammonia from some cleaning products.
- A colour change is produced: acid-base reaction and indicators, when cleaning a stain or synthesizing a dye.
- A solid is formed during the change: cooking an egg (proteins have been denatured by heat) or preparing cement for joining two stone.

For reviewing the latest news, the educational approaches, the research projects, resources, etc., about chemistry visited [1].

For young students, doing experiments for they own is enjoyable only if they understand what they are doing [2, 3]. The way to understand chemical experiments is to reinforce the study of chemistry, observe closely and keep a neat record of their experiments.

To help young students, 10 to 14 years old, to understand more of the fantastic world in which they live it is essential to encourage them to examine the results of chemical experiments as a

true scientist. These students are from Catalan primary and secondary school level [4, 5]. Catalonia is a Spain Autonomous Community.

To bridge the gap between these primary and secondary school students and the chemistry's knowledge, several experiments were designed and activities are focused on this way of "understand chemistry". The experiments were carried out in a fine atmosphere in primary and secondary school classrooms and also in the "openlab" from Scientific Park of Barcelona [6] (Parc Científic de Barcelona, PCR) in where primary and secondary school classes come to attend the experiments.

Working together primary and secondary schools science teachers and scientists from PCR and the University of Barcelona can improve chemistry knowledge in their students and their general negative opinion about chemistry will be modified.

2. Methodology

Primary and secondary school students have to work in groups [7] as a team to increase their co-operational education "each person's work affects the other members".

Teamwork is favourable for all the participants because the interchange of ideas requires them to think in depth about how to solve the chemical problems from the proposed experiments "each group member contributes to the solutions and discussions".

Chemistry experiments performed with young students always need to teach them laboratory safety. Have them wear goggles and protective clothing (laboratory coat and gloves), even if they are working with household chemicals.

Professional chemists take safety seriously and do not rely on their own judgment in "deciding" whether to use goggles and a lab coat; they simple wear safety gear for all laboratory experiments.

3. Experimental approaches

Young students were given a lab coat, a guide with some definitions and questions about the experiments that they will do. Table 1 shows part of the guide and experiments and they can start experimenting in the laboratory.

Fig. 1



Fig. 1. Openlab vision. Laboratory coat on the chair, a pen and the experimental guide on the table are provided for each student.

Name: _____ Date: _____
 School _____

		Experimental part
Physical and chemical changes.	The states of matter.	Nitrogen liquid changes. Water and Carbon dioxide
Separation of mixtures.	Acids and alkalis.	Salt and water. Oil and water. An "Indicator" Red Cabbage.

Table 1. Chemistry experiments

3.1. Physical and chemical changes

Some chemical properties are oxidative or reductive power, acidity or causticity, etc. On the other hand, physical properties are state (solid, liquid and gas), shape, weight and density, speed, magnetism and so on. When there is a variation in the chemical or physical properties the compound presents a chemical or physical change, respectively.

A physical change maintains the molecular integrity of the substance it does not produce a new substance. However, a chemical change happens on a much smaller scale and implies the transformation of a substance in other, with a different molecular constitution.



Fig. 2. Inflated balloon into liquid nitrogen.

What is liquid nitrogen? Nitrogen is a gas which forms part of the air and we can obtain it in liquid state at $-198.5\text{ }^{\circ}\text{C}$ and 1 atm pressure. How

to change the physical properties of air in contact with liquid nitrogen?

Experimental approaches

Only the teacher must developed this experience because liquid nitrogen could cause irreparable damage to the students' skin.

Take an inflated balloon and submerge it in liquid nitrogen, what happens? It can observe in Figure 2 that into the liquid nitrogen the gas (air) contained inside the balloon is cooled and its volume diminishes. However, if the balloon is removed from the liquid nitrogen the air temperature will increase and will recover its initial volume.

Explain what happens when a flower, a leaf or a rubber glove are submerged in liquid nitrogen (homework question).

3.2. The states of matter

There are three basic states of matter: solid, liquid, and gas. Everything on Earth is made up of microscopic particles (molecules, ions, or atoms), and the amount, speed and density of these particles determine which state of matter and object is.

Solid. A substance in solid state is anything that holds a particular size and shape. A plastic chair, a block of wood, a gold ring and a beaker are all solids. The particles in a solid are tightly packed and don't make a lot of movements.

Liquid. A substance in liquid state is anything that has a constant volume, but does not have a shape. Liquids must be contained in an Erlenmeyer, bottle, or receptacle in order to have a shape. Water, orange juice and ethanol are liquids at room temperature. The particles from a liquid are not as close together as particles in a solid and move around more freely.

Gas. A substance in gas state is anything that has no constant volume either shape. Air is a combination of many gases. In addition, the bubbles from sparkling water are gas (carbon dioxide). The particles in a gas move freely at high speeds.

3.2.1. Water (H_2O)

These young students from primary and secondary school know the chemical formula of water, it is H_2O .

When the temperature of the water goes up, the molecules get more excited and bounce a lot more. If you give liquid water enough energy, it

becomes a gas.

Questions from the guide are:

If there is water vapour into air, in which states of matter can water be presented?

Table 2.	Melting point	Boiling point
Water (H ₂ O) at 1 atm.	0°C	100°C

What is ice? Ice is water in solid state. At what temperature does it melt? At what temperature does water boil?

The students' answers, melting and boiling points and the names of changes in the state of matter, are presented in Table 2.

Most of students may have also seen a solid become a gas. It's a process called sublimation. The easiest example of sublimation might be dry ice.

3.2.2. Dry ice (CO₂ solid)

What is dry ice? It is carbon dioxide (CO₂) in the solid state which sublimates at -78 °C.

What happens when you put "dry ice" into water? What is the smoke that rises?

If dry ice (solid carbon dioxide) is added to an Erlenmeyer flask or a beaker with water it will observe a strong detachment of bubbles of carbon dioxide. In fact, carbon dioxide reacts with water forming carbonic acid, an unstable weak acid, which quickly decomposes into water and carbon dioxide (the smoke that rises).

Explain what happens when you heat a little ice (homework).

3.3. Separation of mixtures

What is a mixture?

All matter is composed of atoms. Chemical elements have the same kind of atoms (Fe iron, Cu copper, Au gold, Hg mercury,...). Chemical compounds or molecules are a union the same or different chemical elements (O₂ oxygen, H₂O

water, CO₂ carbon dioxide, CH₃-COOH acetic acid or vinegar,...).

If the atoms or molecules that make up matter are different then we have a mixture.

Heterogeneous mixtures are those whose components can easily be detected and separated sand and water (Fig. 4), sand and iron nails, salt and iron nails, etc.

Solutions or homogeneous mixtures are such whose components cannot be distinguished, a pinch of salt in water, sugar in milk, etc.

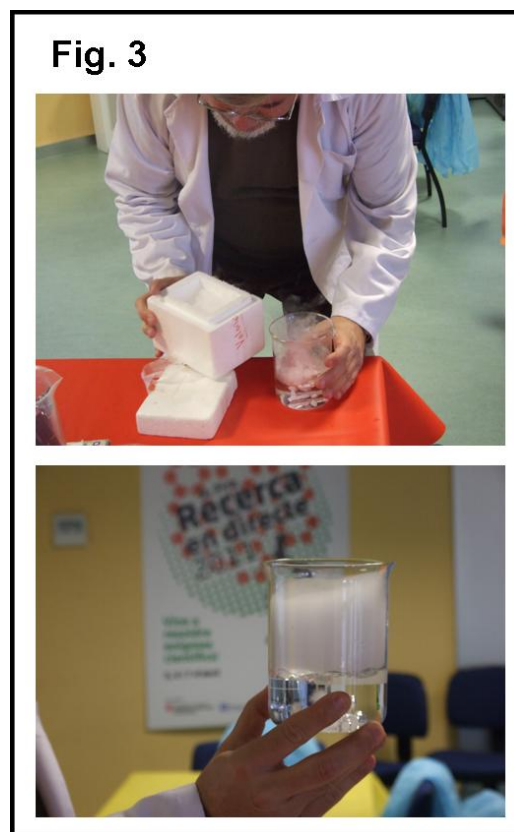

Fig. 3. Sublimation of dry ice.

Experimental approaches

a) With a plastic Pasteur pipette carefully put water and a little oil into a plastic tube with a tap.

Cover and shake the tube. What happens with the oil and the water? The drops of oil are discernibly suspended in the water. Let the tube rest, observe and record what happens.

Which substance appears at the bottom of the tube? And why? Water appears at the bottom because its density is higher than the oils density.

Which substance floats? And why? Oil floats because has a lower density than water.

Separate, with the aid of a Pasteur pipette,

the oil from the water by taking only the oil and pass it to another tube.

Draw and explain what the teacher does with the separator funnel (homework).

b) With a spatula take a little salt or sodium chloride (NaCl) and place it in a tube with water. Shake until the salt cannot be seen anymore.

What kind of mixture have you prepared? Students have prepared a solution (homogeneous mixture). Although invisible, do you think there is salt in the solution? Yes, there is.

The "solute" is sodium chloride which is the "solvent"? It is water.

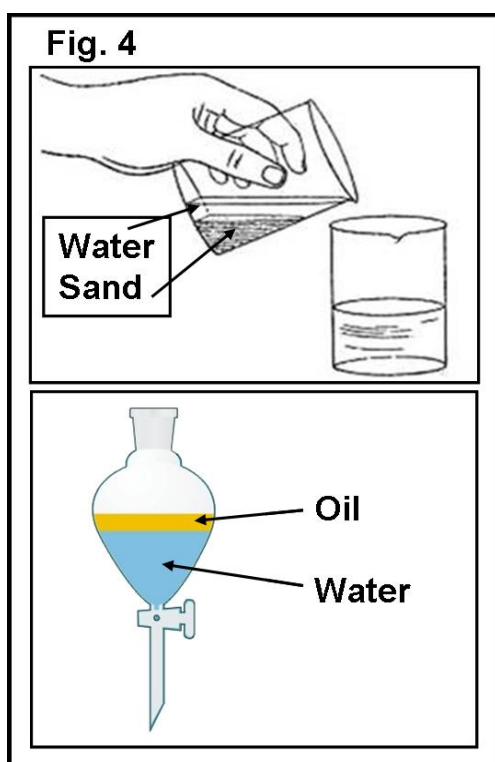

Fig. 4. Separation by decanting (sand and water) and a separator funnel (oil and water)

3.4. Acids and alkalis or bases

3.4.1. Chemical reactions

A chemical reaction occurs when one or more substances are transformed into other/s that have chemical properties very different from those they had first.

When burning petrol to run a car engine we start a chemical reaction. Petrol reacts with oxygen from the air and forms carbon dioxide and water. Our body burns food for obtaining energy. The

process of burning food in our bodies requires oxygen from air we breathe. Food reacts with oxygen and forms carbon dioxide and water. These two are combustion reactions.

Examples of chemical compounds are the dyes used to change the colour of clothes, hair and other products, the medicines and vaccines used to stop diseases, the cleaning products such as soaps and perfumes etc. All this is the chemistry you live with every day.

3.4.2. Acids and bases

Students of any level can learn that many substances are classified as either acidic or basic. They can also understand that these designations are important to chemists as they attempt to understand the properties of materials. Knowing about the fundamental properties of a substance helps chemists in their work. In this experiment you will learn how acids and bases react when they are put together.



Fig. 5. Hydrochloric acid (HCl), potassium hydroxide (KOH) and phenolphthalein.

Acids and bases in Nature. There are many strong acids and bases in nature. Some of them are dangerous and used as poisons by insects and animals (formic acid). Some are helpful (acetic acid or vinegar). Many plants have acids and

bases in their leaves, seeds, or even their sap. Citrus fruits like lemons and oranges have citric acid in their juice.

3.4.3. Acid-base indicators

One of the best ways to explore acid-base properties is by using a substance known as an acid-base indicator. An acid-base indicator changes colours, and the colour of the indicator depends on the acid or base nature of the substance you mix with the indicator. Thus, a simple colour change gives chemical information.

Write down which reaction takes place between the calcium hydroxide and carbon dioxide? (homework).

What acidic substances do you know?

What basic substances do you know?

The phenolphthalein is an indicator of acid – base as you can see in Figure 5.

Table 3 shows the colours that present an acidic solution (hydrochloric acid HCl) and a basic solution (sodium hydroxide NaOH) when they react with three acid-base indicators.

Table 3 substance	Colour with		
	phenolphthalein	Tornasol	Red cabbage
acid	Transparent	Red	Violet
base	Pink	Blue	Yellow

Students can make your own acid-base indicator with red cabbage as shows Figure 6.

1.- Simply chop up the vegetable into small pieces add ethanol and grind with clean sand. Then filter out the plant material, sand and the liquid through a filter in a funnel.

2.-. Simply chop up the vegetable into small pieces, add boiling water, and let it sit for ten minutes. Next, filter out the solid plant material by pouring the liquid through a filter in a funnel.

The result is a liquid called flavin. Exposing the flavin solution to acids like lemon juice or vinegar will cause it to turn red. Adding a base such as baking soda (sodium bicarbonate), ammonia, or lye will cause it to yellow-green. There is a difference in the quality of the colour depending on how much acid or base added.



Fig. 6. Obtaining red cabbage indicator.

4. Conclusion

The feedback that we have received from primary and secondary school students and their science teachers has been very positive.

Laboratory experiments have modified their initial bad opinion about chemistry.

This educational approach could be used by primary and secondary school science teachers in their chemistry classrooms.

It is essential to incorporate elementary chemistry between young people, our future society, if we want to increase the interest and study of chemistry in our society.

Acknowledgment.

We thank the teaching staff from all primary and secondary schools who participated in this activity. We also thank Mr. Jordi Fernández for revising the English manuscript. This activity was supported by the Technical Section of Education from the College of Chemistry of Catalonia (CQC).

References

- [1] <http://www.chemistry2011.org>
- [2] Zaragoza Doménech C, Fernández-Novell JM. Teaching science with toys: toys and physics. Hands on science: Bridging the science and society gap. University of Crete; 2010. p. 63-68.

- [3] Fernández-Novell JM, Zaragoza C, Fernández-Zaragoz J. Chemistry Education: Children and Chemistry. In: Divjak S, editor. Proceedings of the International Conference on Hands on Science; 2011 Sep 15-17; Ljubljana, Slovenia. Ljubljana: University of Ljubljana; 2011. p. 5-15.
- [4] <http://www.xtec.cat/web/curriculum/primaria>
- [5] <http://www.xtec.cat/web/curriculum/secondaria>
- [6] <http://www.pcb.ub.edu>
- [7] Dennick RG, Exley K. Teaching and learning in groups and teams. *Biochemical Education*; 1998, 26, 111-115



MASTERCLASSES AND INFORMAL EDUCATION IN SLOVAKIA

**Júlia Hlaváčová¹, Marek Bombara²,
Alexander Dirner², Mikuláš Gintner³,
Ivan Melo³, Boris Tomášik⁴,
Pavol Bartoš⁵, František Franko⁶**

¹*Department of Physics, Technical
University of Košice, Košice, Slovakia*

²*Institute of Physics, P. J. Šafárik University,
Košice, Slovakia*

³*Department of Physics, University of
Žilina, Žilina, Slovakia*

⁴*Department of Physics, M. Bel
University, B. Bystrica, Slovakia*

⁵*Department of Nuclear Physics and
Biophysics, Comenius University,
Bratislava, Slovakia*

⁶*Center of Competencies and Long-live
Learning, University of Prešov, Prešov,
Slovakia*

*boris.tomasik@umb.sk,
julia.hlavacova@tuke.sk,
marek.bombara@upjs.sk,,
alexander.dirner@upjs.sk,
gintner@fyzika.uniza.sk,
melo@fyzika.uniza.sk
bartos.palik@gmail.com
frantisek.franko@unipo.sk*

Abstract. *Six Slovak universities have been participating since 2005 in the international project for high school students, Masterclasses – Hands on Particle Physics (MC). The positive response from students became a challenge for us to prepare more activities of informal education as regional MC, MC on cosmic rays, CASCADE project, summer schools, distance course on modern physics, interactive exhibitions. The aim of these activities is to acquaint high school students with some up-to-date results in natural science research and to increase their interest in physics and other natural sciences in a new attractive form.*

Keywords. Distance course, informal education, masterclasses, summer school.

1. Introduction

One of the most important activities in physics education and popularization among secondary school students has been the project organized by the International Particle Physics Outreach Group and European Physical Society called “Hands on Particle Physics – European Physics Masterclasses for High School Students” (MC). It has been held since 2005 – World Year of Physics, each year. The students came for one day to nearby academic center where lectures on elementary particles and forces between them as well as on the methods of basic research were given to them by experienced scientists. After lectures the students could themselves perform measurements on real data from particle physics experiments in CERN. The last three years they processed real events obtained on Large Hadron Collider (LHC) using special software. At the end of the day the participants joined a video conference led by young physicists from CERN to discuss their results.

Further activities aimed to support the interest of high school students in physics and natural sciences, to acquaint them with the up-to-date research results and to increase their knowledge have been prepared, mainly: regional MC, MC on cosmic rays and astronomy, CASCADE project, summer schools on elementary particle physics and on cosmic physics, and distance education in modern physics [1, 2].

2. Regional Masterclasses

Not all high school students who are interested in physics can participate in international MC because their number is limited. In order to provide opportunity for more students to take part in a similar event we have organized regional MC at secondary schools mainly in East – Slovakian region. The content of regional MC is the same as of the international one except the videoconference. Students at their school are given lectures and then using their PC classes they process real experimental data from CERN themselves. Instead of the videoconference there is a discussion of results obtained with physicists which is followed by a knowledge quiz (Fig. 1). Since 2008 this project has been realized at 13 secondary schools, at each one about 40 – 50 students took part in this event.

Till 2010 the students during regional MC analyzed experimental data from Large Electron – Positron Collider (LEP) in CERN. The purpose

was to analyze pictures of collisions of Z-decays and to measure the branching ratios of the Z particle. The branching ratios tell how often the Z boson decays into different kinds of particles. The Z particle can decay either into two electrons, two muons, two tau particles, two neutrinos or into two quarks. The frequencies of the different kinds of decays can be calculated theoretically using the Standard Model. The students measured how often the different decays occur and compared their results with the theoretical predictions of the Standard Model. These results could be used later to calculate the strong coupling constant [3].

Question 3

How do we see "quarks" in a detector?
 W jaki sposób możemy zobaczyć "kwarki" w detektorze?
 Ako vidíme "kvarky" v detektore ?

A. Not at all
 B. By their characteristic spiral trajectory
 C. Via "jets" of hadrons they generate
 D. As two individual straight tracks in opposite directions

A. W ogóle nie możemy.
 B. Poprzez ich charakterystyczną spiralną trajektorię.
 C. Poprzez strumień hadronów, który one generują.
 D. Jako dwa oddzielne proste ślady w przeciwnych kierunkach

A. Vôbec ich nevidíme
 B. Podľa ich charakteristickej špirálovitej trajektórie
 C. Cez "jety" hadronov, ktoré kvarky generujú
 D. Ako dve individuálne priame dráhy v opačných smeroch

Hands on Particle Physics[®]
 International Masterclasses

Figure 1. Quiz question from regional MC

In 2011 the analysis of experimental data from LHC started also at regional MC. Several tasks concerning the data obtained in the ATLAS and ALLICE experiments have been prepared for students together with the software for data processing. Two of them from the ATLAS data were chosen for the regional MC: 1. Rediscovery of Z boson using the analysis of the products of Z decay (electron – positron, muon - antimuon) and Z mass reconstruction. 2. The study of proton structure using the ratio of the W^+ and W^- bosons produced which is proportional to the ratio of the number of u quarks to the number of d quarks inside the proton, so the expected value of the ratio is equal to 2 [4, 2].

3. MC on cosmic rays and astronomy

We used the experience gained in MC on particle physics for preparing MC on two close topics – cosmic radiation and astronomy.

Cosmic rays consist of high-energy particles (primary) coming to the Earth from outer space and a shower of secondary particles created in

the earth atmosphere as a consequence of interaction of primary particle with the atmosphere. The composition of charged primary particles varies with energy, however, about 86% primary particles are protons, 11% alpha particles (helium nuclei), 1% heavier nuclei and 2% electrons [5]. Neutral primary particles are composed of photons, neutrinos and antineutrinos. Some of the possible cosmic rays sources are: interstellar ionized gas, supernovas or active galactic nuclei. Energy spectrum of cosmic rays reaches values between $10^{20} - 10^{21}$ eV.

The SKALTA experiment (SlovaKiAn Large-area Time coincidence Array) was used for MC on cosmic rays. SKALTA is the first project of its kind for cosmic rays detection in Slovakia (Fig. 2). The working station is composed of three scintillation detectors each with the dimensions 60cmx60cm which are connected in coincidence. The detectors are put in a plastic coverage with stable temperature inside. The detectors are arranged into a triangle with side length of 10 m. The area of the triangle defines a minimal size of the shower and therefore a minimal energy of original primary particle ($> 10^{14}$ eV). The detector signals are recorded by electronics which is connected to computer. Using the time difference among the signals from the detectors the point in the sky can be localized (up to a certain resolution) from which the original primary particle came from. By the measuring of the exact time by GPS (Global Positioning System) the data from other workstations (i.e. ALTA, CZELTA [6]) can be compared and long distance correlations can be studied.



Figure 2. SKALTA working station

Two problems were given to students to solve: 1. Is the cosmic ray measured by SKALTA ($> 10^{14}$ eV) affected by the Sun? (Or alternatively, does it come from the Sun?). 2. What is the relation between secondary cosmic ray flux and air temperature and density? The first problem was to be solved by comparing the numbers of the showers of secondary cosmic rays measured by SKALTA during the day and during the night (Fig. 3).

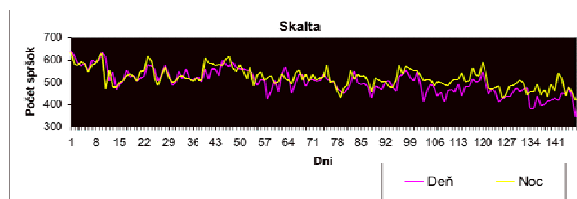

Figure 3. SKALTA events during the day and night analysed by students

These numbers were not influenced by the Sun and thus the origin of the cosmic rays detected by SKALTA is outside the Solar system. The outcome of the analysis of the second problem were to be 3 plots with SKALTA event number, air temperature and air density as a function of time, the comparison among them led to the resulting interpretation. No correlation were found between the temperature and SKALTA event numbers, anti-correlation was found between SKALTA event number and air density. The atmosphere thus acts like a huge calorimeter in which the absorption ability of charged particles is strongly connected with its density [7].

The task for students in Astronomical MC was to find out the trajectories of some asteroids in the Solar System. After the lecture on collisions of comets and asteroids with planets of the Solar System they were given a short instruction concerning the software used as well as the methods for trajectories determination. The students could learn more on the topic using the java applet with real data for simulations (Fig. 4) [8].

The main task was to find out the threat of collisions of an asteroid with the Earth using the real central database JPL NASA which has been continually renewed from the world wide net of observatories and satellite observations [9].

4. Summer schools

Summer school is a 5-days stay of about 50 students from different high schools in East Slovakia in the School in Nature in picturesque

countryside of Kysak. The aim of this activity is the popularization of natural sciences and education in an attractive and entertaining way. Each summer school includes a few introductory lectures on given topics, practical activities for students, informal discussions with physicists, one day visit to East Slovakian academic or scientific institutions and the competition of student presentations at a closing workshop.

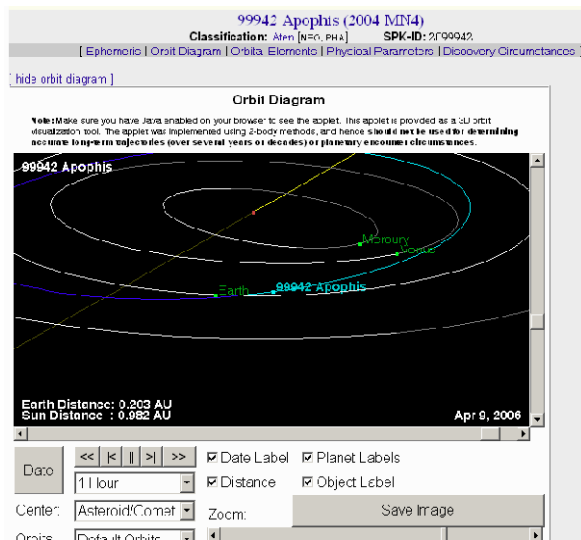

Figure 4. Java applet used during the astronomical MC

In the first summer school in 2008 students were expected to show manual dexterity since it was aimed mainly at modeling of new experimental apparatus in CERN – accelerators, collider, detectors. The best models were then exhibited at the interactive exhibition “The Slovak Way to Microworld” (Fig 5.).



Figure 5. Models prepared by students

The summer school in 2009 was called “Galileo would wonder” and it was dedicated to the 400-

th anniversary of telescope discovery by Galileo Galilei. Its topic was astronomy and cosmology and their connection with particle physics. The experimental part consisted of observing the sky at night, analyzing real astronomical experimental data obtained via Internet and visiting astrophysical institutes in the High Tatras. Participants visited also the Department of Physics at the Technical University of Košice where they, divided into small teams, measured and processed several computer-supported laboratory practicals. As a practical part the students prepared space rocket models and tested their start and flight. A new form of discussion with scientists was introduced – a so-called “living library”. Students formed several about 5-member groups and each group had a discussion with one physicist, after about half an hour physicists joined another discussion group. Discussions in such small groups were very informal and open, students realized e.g. how pleasant and witty people physicists can be. For the last afternoon workshop students prepared short presentations on topics related to the topic of the summer school.

The next summer school in 2010 was called “The Big Impact of Tiny Particles”. Its main aim was to acquaint students with the newest results obtained on the Large Hadron Collider in CERN and with challenges for particle physicists. In its experimental part students processed real experimental data from CERN (MC) and visited academic and research institutes in Košice. At the Department of Physics two new attractive experiments from the field of modern physics were prepared for them. They observed electromagnetic waves, their propagation and measured the speed of light. Then they could discover one of the mysteries of quantum physics analyzing the electron diffraction. As an introduction to each experiment there was a short Power Point presentation on the physical and methodical background of particular physical phenomenon and demonstration given by the teacher. It was followed by performing the experiment and processing the measured data by students themselves (using the manual prepared and the help of teacher).

“The Unknown Cosmic Radiation” was the name of the summer school in 2011 which was dedicated to the 100-th anniversary of cosmic radiation discovery by Victor Hess. The SKALTA experiment was used for MC on cosmic rays as experimental part in this summer school.

The topic of summer school in 2012 was meteorology and it was named “Water and Air in Motion”.

In order to get feedback from students a few evaluating surveys were done among them which showed that the students found the summer school stays very interesting and pleasant and they preferred and appreciated most the activities of the experimental block, mainly those which they did themselves – as, e.g., experiments at the Department of Physics [10].

5. Distance course

In March 2010 a new activity was started - a 12-week distance course “Windows into Modern Physics” in MOODLE environment for secondary school students to deepen their interest in physics, natural sciences and up-to-date research as well as to increase their knowledge in these fields. The course consists of 10 parts – modules: Atom, Nucleus, Basic Forces, Standard Model, Accelerators, Detectors, Laboratory Practical, CERN, Quark-Gluon Plasma, Physics in Medicine and its aim is to acquaint students with new attractive parts of physics and physical research. These parts are usually not included into physics lessons at secondary schools in detail. The course deals with elementary particles of which the whole known Universe is built, with the forces between them which keep them together and also with the methods used in the study of microworld. The course provides also an insight into the world newest and largest experimental apparatus as the LHC in CERN.

Each module, in addition to the basic educational text, contains several different items – links to interesting web sites related to a particular topic for further study, a self - evaluating test which makes it possible for the student to check the understanding of the basic ideas described in a particular module. At the end of the course there is another more general test with questions concerning the content of all modules and students get points for answering the test questions. A discussion forum is opened during the whole course duration where students, teachers and course authors - tutors can ask and answer questions or write about any thing which they have found interesting or remarkable. The whole course – on-line study is continuously electronically evaluated. During the course there are usually two presence sessions of students with tutors. The first one takes place after seven weeks from the beginning (six modules and

Laboratory Practical are opened), the introduction for the session is the module Laboratory Practical. During the session students process themselves experimental data from CERN (similarly as at MC). The second session is the closing activity of the course (usually two weeks after the course was finished in order to have time to prepare presentations). Its main part is the presentation competition. Students teams (usually of about two students) give a five minutes long presentation which they prepared on a chosen topic, e.g., What is the world made of?, Basic forces in the nature, Hubble’s telescope – back in time, Big Bang and Universe evolution, What is behind the Standard Model?, Elementary particles and the early Universe, The theory of everything – science or science-fiction?. The most successful course participants and the winners of the presentation competition were awarded the prizes, e.g, a week stay in CERN or at the Czech Technical University in Prague at the Science week, books, USB flash drives.

At the last session all participants of the first run of the course took part in an evaluating survey in questionnaire form, its aim was to find out the students' opinions on the duration, content and form of the course. 84% of participants were satisfied with the duration of the course (one module per week), the average time needed for one module study was 0.5 – 1 hour. It turned out that students use PC on average for about three hours per week, mostly looking for entertainment and contacting friends, less for education. It could be due to the fact that there is not enough attractive educational web sites. One question concerned the level of knowledge before and after the course. The answers showed that at the beginning of the course the level of knowledge on all topics was very low but after finishing it the level significantly increased. The students appreciated the educational texts very much, they were not so much satisfied with the electronic sources. It resulted from the survey that the course was well-done and very attractive, students were very satisfied with the knowledge they gained. The most attractive for the students was new interesting information, the possibility of on-line study as well as the personal contact with the tutors and presence sessions. They would appreciate more animations and videos related to the texts and more presence sessions. The survey results helped us to increase the quality of the next course [1].

6. Conclusions

The aim of all activities mentioned above is to acquaint students with the basic questions which physics can answer in a new attractive way and in this way to increase their interest in physics. Natural sciences popularization and informal education in Slovakia include even more activities. An interactive exhibition “The Slovak Way to Microworld” with students as lectors was prepared and installed in several towns in Slovakia. The aim of the exhibition was not only to popularize but also to educate. Panels provided information about experiments in CERN (Fig. 6.).



Figure 6. Exhibition panels

The exhibition part of multimedia presentations and demonstration experiments was very interesting. There was e.g. an animation of the particle traveling through the accelerator until the collision takes place.



Figure 7. The Adventure of Discoveries

The other exhibition was “The Universe – the Adventure of Discoveries” [11] (Fig. 7). Both exhibitions were accompanied with the competition of paintings and photographs of young people.

Another activity is the CASCADE project [12] which was inspired by the CASCADE project organized at the University of Birmingham in 2007. Our project is a competition of presentations on a chosen topic concerning modern physics for high school students all over Slovakia. A group of three students prepares a 30 minutes long presentation for students at their school. The presentations are recorded and then the jury (using video records) chooses the five best ones and their authors are invited to participate in the final round which takes place at one of the high schools. The project started in 2009 with 4 teams, during following years there were about 15 teams in competition.



Figure 8. CASCADE student presentation

The mentioned activities which differ in form and content provide a complementary source of information on modern physics for more students who can also choose the level which suits them best.

7. Acknowledgements

The support of the APVV project LPP-0059-09 and the KEGA project 022ŽU-4/2013 is acknowledged.

8. References

- [1] A. Dirner a kol., Pohľady do mikrosвета, Festival fyziky - Tvorivý učiteľ fyziky III, Smolenice 2010, ISBN:978-80-969124-9-0, (2010) 187–197.
- [2] A. Dirner a kol., Študenti odhaľujú krásu časticovej fyziky, Festival fyziky - Tvorivý

- učiteľ fyziky IV, Smolenice 2011, ISBN:978-80-970625-3-8, (2011) 50–63.
- [3] Hands on CERN, http://hands-on-cern.physto.se/hoc_v21en/.
- [4] International Masterclasses, Hands on Particle Physics, <http://atlas.physicsmasterclasses.org/en/index.htm>.
- [5] Perkins DH. *Particle Astrophysics*. Oxford University Press, 2009, ISBN: 978-0-19-954545-9, p.229-271
- [6] ALTA (Alberta Large-area Time coincidence Array): <http://csr.phys.ualberta.ca/~alta/>
- [7] CZELTA (CZEch Large-area Time coincidence Array). <http://www.utef.cvut.cz/czelta/czelta-cz>
- [8] Bombara M a kol. Cosmic Ray Study in the SKALTA Experiment(2), 17. Konferencia slovenských a českých fyzikov, Žilina 2011, ISBN 978-80-970625-4-5, (2012) 93-94.
- [9] <http://www.neave.com/planetarium/>
<http://www.wikisky.org/>
- [10] <http://neo.jpl.nasa.gov/orbits>
- [11] Kimák I a kol., Bádateľsky orientované činnosti v programe pobytových podujatí projektu Mikrokozmos, IV. odborná konferencia Quo Vadis, Bratislava. 2011, ISBN 978-80-970496-6-9, (2011) 139-144.
- [12] Dirner A a kol., Cez mikrokozmos k poznaniu makrokozmu, Festival fyziky – Tvorivý učiteľ fyziky II, Smolenice 2009, ISBN:978-80-969124-8-3,(2009),72–82.
- [13]
- [14] <http://ippog.web.cern.ch/resources/2011/cascade-projects-slovakia>

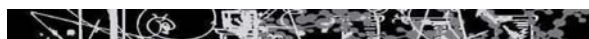

**10TH INTERNATIONAL
CONFERENCE ON HANDS-ON
SCIENCE 1 - 5 JULY
2013 KOŠICE, SLOVAKIA
SPIE Scholarship; benefits and
responsibility**

Clementina Timus

*National Institute for Laser, Plasma and
Radiation Physics*

Bucharest

clementina.timus@inflpr.ro

Abstract. *A long SPIE membership of the author and close contacts with the different activities supported by SPIE, among which a three years mission as scholarship evaluator allows to make some comments and recommendations. Comments upon specific features of the education nowadays connected to the globalizations and UNESCO statistics are included, as well. The policy of SPIE and OSA is to encourage young people to be actively involved in the society to disseminate the scientific information. The mission of the professional associations is to increase the interest of future scientists to serve the human being. The contact with the extracurricular activities favors the young scientists to choose the most useful scientific fields. It is to mention the interest of students to attend the important conferences to be able to present the results of their activities, to meet famous professors and be accepted in famous scientific teams.*

The evaluator experience is of high interest, as well, since it allows to compare the level of students all over the world, to see the trends in education, to appreciate the level of schools, the interest of students for the famous universities and many other aspects to be discussed.

KeyWords. scholarship, responsibility, professional level, globalization, senior and young scientist

Introduction

For long time coordinator of SPIE Student Chapter in Romania, the invitation to serve as evaluator was an attractive activity and allows to have a general view upon the student education and trends, nowadays, when the globalization is

a running event and the tendency of students to move all over the world, mainly towards the famous universities to be able to perform and have access to the best jobs.

The author is presenting some considerations and observations based on a three years experience as evaluator. The reason to propose this contribution is the strong feeling of the author that for any professional besides the interest for the very specific features of the scientific specialty it is a problem of ethics to honor this field and if it not always possible to have important personal contributions in your profession, it is a moral duty to respect the predecessor contributions and promote them. It is the mission of any professional association to preserve the fame of the field and make young people proud to belong to this profession. The strategy of the professional associations as SPIE and OSA is to ever increase the interest for science, to promote the gifted young people and help them to improve the scientific level. The scholarship is enlarging the education opportunities to students, is favoring to improve the professional level and encouraging the future leaders of the scientific community. Being in the competition is the best way to ever improve yourself, to be in contact with people coming from different other cultures, knowing different ways to think and act about the future of the field of your research and for sure able to better know to *“what my research is useful for”*?

Comments upon scholarship

The scholarship grant competition is launched every year and the application form consists in some questions to establish the education level of the candidate students, the extracurricular activities, an essay to describe the intention to use the money and two recommendation letters. All the points mentioned are quoted and some comments of the evaluator justify the decision, if necessary.

The schedule of the scholarship evaluation is very sharp established and respected by all the members of the Scholarship Committee and the correctness is assured by very strict rules: every application is twice evaluated and each evaluator is signing a “Conflict of interest Policy” and never an evaluator judge the co national students. The Scholarship Committee Members coordinated by the chair vote the recommendations established according the SPIE strategy, the surveys launched to consult the

members of the community and have their proposals. The budget is rigorously distributed and the list of awarded students is open to be consulted by all the evaluators.

The CV and the publication list inform the evaluator about the level of education and it is very relevant for comparing the applicants. The most important point is the essay in which the candidate introduces him/herself by describing the domain of professional interest, making proof of how master is upon the subject, the previous research reflected in published papers and the future intentions to improve his/her professional level.

According the CV the best students applying for scholarship have a very consistent background, an impressive list of published papers in the peer reviewed journals. It is easy to notice the difference between such students and others still hesitating, making side comments just to fulfill the essay as words number.

The extra curricula activities and the awards are also important to be seriously treated by the applicants, since these aspects show the interest of the student to organize the future of the career in order to be integrated in the society. The young scientists become aware about their mission, to be helpful for the society to ever keep the stimulating curiosity to find solutions in an ever moving society with higher needs and controversial laws. Many applicants are provided by the Asian space where there are still problems regarding the large access of people to education. Some essays contain emotional confessions of the applicants regarding the status of education in their countries and the sincere motivation to promote on a higher level of education.

The letters of recommendation are important as well to convince the evaluator how close is the student to the research field, the professional capacity, the ability to work in the team, the leadership features, the interest to transmit information, to develop activities in the society. It is to notice that many students from the emerging countries are in contact with co national professors already serving in the US universities or other European universities and help the student to be able to accomplish their professional level. These contacts are very important for home universities.

The scientific research is a creative activity, which means a continuous effort of improving the professional level by very different means: first of all, the ever increasing responsibility for your own professional condition to follow the

steps of the hierarchy, to be faithful to your profession and finally to ever become more generous to transmit the skill to the young generations. The mission of education of new generations is not only a need but is a way of improving your own condition since the dialog between professor and student is always reciprocally fruitful, inciting, creative, ever a miracle.

From some letters it is interesting to remark the special and subtle relationship between professor and young scientist in this creative process of formation, which is stimulating for the both, since the experience of the senior is thus creatively matched with the curiosity, boldness and diligence of the gifted student, really integrated in the research team and developing leader skill.

The enthusiasm of young people is the active motor of the research activity and being evaluator it is possible to notice and guess a real future scientist, it is a great pleasure and satisfaction for the coordinators to have such brave students and contribute to their formation. The scientific career is accomplished not only by the single contribution of the researcher but by their activity as coordinator of opinion leaders or discoverers of new gifts in science. For this I'm positive the strategy of professional societies have a high mission and the organization of the large conferences, the opportunity to gather the most impressive brains if the different scientific domains and the aspirants to the future trends. It is to notice the satisfaction of some professors to stress the leader features of some students.

It happens, some letters to contain more scientific information about the level of research, that is not mention in the essay; this means either the letter was written after a report or the recommender was too generous to help the student to have a successful application.

Some recommendation letters are too generous to favor the candidate, but some professors really show how close is the student to the subject and really involved to solve problems and have objective opinions. The evaluator has no doubt about the high importance for any applicant to be awarded in this competition, but he has to be fair to make difference between diligent students and those who just try to benefit of a travel to attend a conference. This is a hard task and it is necessary to be very honest.

The majority of students intend to use the grant for attending the conferences to be able to present their results, to joint the important teams

establishing new contacts and promoting in the field. Some need to purchase books, or IT accessories.

The advice would be the students who intend to apply for scholarship to be very serious at every detail to be written in the application in their favor.

I was impressed by the number of excellent applications, well elaborated publications in peer reviewed journals, serious activities, and high motivation: mature managing of their future, ability to speculate advantages of the market, approach interdisciplinary activities, interesting applications in bio photonics having background in electrical engineering.

Statistics

Regarding the statistic the highest number of applicants is except US, from China, India, Russian Federation, Iran, Turkey and other ex Sovietic countries as Ukraine. It is to note that many applications from China, India and Russian Federation are very serious. In the last edition the number of successful applications from China was 21, Russian Federation 12, Ukraine 4, Iran 6, India 10, Turkey 4, Taiwan 5; nevertheless when I was more attentive to read the names of US candidates I found many Chinese names, which means that there are already many Chinese residents In US, and other nationalities, as well. As far as I could notice the best applications have been written by students with a serious background in IT and electrical engineering from China, India and Russian Federation, that means these students could match the theoretical and technical knowledge.

The number of applications from Europe is much lower, probably because the students from the Central and Eastern European countries choose the western European countries for MSci and PhD studies.

Since the different education levels MSc or PhD levels means the elaboration of the graduation thesis the number of publications is important.

According UIS [1] the highest number of researchers in US and the best conditions to develop high top research is the reason the large number of students apply for US universities. Regarding the bibliometric indicators the conclusion is that the share of world scientific publications declined in the developed countries over the last 20 years. It is to note an increased share of publications in collaboration of scientists from developing countries with those

from developed countries.

Recently the travel grants are available for High school students as well. It is usual that the winners of the International Olympiad contests are invited to continue the education in the US colleges and universities.

The interest of student to defend the MSci or PhD titles in top universities is driven by academic, Mobility of doctorate holders is driven academic, job related as well as family and personal reasons.

Migration and mobility patterns of doctoral graduates are similar to those of other tertiary level and other categories of the population with important flows towards the United States, principally from the Asian countries, and large intra-European flows, notably towards France, Germany and the United Kingdom.

15% to 30% of doctorate holders from European countries, for which data are available, who are citizens of the reporting country have experienced mobility abroad during the past ten years.[2]

The author considers the observations useful to establish a policy in the domain, and possible some milestones to have a strategy.

Conclusions

The scholarship is open for all the students all over the world and contribute to improve the level of education, one of the components of the Human Development Index (HDI). It is recommended that this opportunity to be used and students to be informed and take profit of it. Being successful in an application and able to benefit of a grant means an important stimulus for any student.

The teams formed from different nationality students, provided by different worldwide schools means new opportunities to enlarge the scientific approach and be more efficient both students and professors. It is to notice the enthusiastic pleasure some professors show in the recommendation letter, when they discover a gifted young people with leader qualities to propose and move forwards the scientific activity.

Finding a good application the evaluator tries to have more information about the home university of the student; generally, these universities are technical ones from Asia or Russian Federation and there are not a single student provided from, but some. Such students conscious about their

level are keen to promote towards the best research centers, attend the conferences where to meet professors interested in their skill. Their level of knowledge and technical skill allow to choose to work in the most attractive scientific domains, as bio photonics, communication, imagistic, high education. Many of them use to think to business, as well.

It is a very interesting experience even for the evaluator, to be able to conclude about the level of students all over the world, the trends of modern science, the very special relationship between students and professors, the stimulating effects upon both when the prestigious experience of the professor is combining with the stimulating curiosity and diligence of the young people keen to promote in science.

The author proposal would be a special course to introduce the students in the futurology of their investigation fields to be informed about the recent trends based on different statistics combining the theoretical and practical valorization of the knowledge.

If a student wants to take profit from the opportunity of travel to attend the main conferences it is recommended to inform previously about the activities developed by an association and of course about the duties and rights. To attend a conference is nevertheless an important professional benefit, for which you have to be prepared and motivated on long term, this is not a reward for everybody. It is for students able to understand the presentations, able to establish contacts and offer their skill.

I hope these remarks to be useful for students intending to apply for scholarships to be attentive at all the questions and being able to convince the evaluator upon his/her quality.

The very recent report of UNESCO Statistics on development is entitled “Human development Report 2013 “The Rise of the South: Human Progress in a Diverse World I found the confirmation of some of my remarks as evaluator.

All groups and regions have seen notable improvement in all HDI components, with faster progress in low and medium HDI countries. On this basis, the world is becoming less unequal. Nevertheless, national averages hide large variations in human experience. Wide disparities remain within countries of both the North and the South, and income inequality within and between many countries has been rising.

Although most developing countries have done well, a large number of countries have done

particularly well—in what can be called the “rise of the South”. Some of the largest countries have made rapid advances, notably Brazil, China, India, Indonesia, South Africa and Turkey. But there has also been substantial progress in smaller economies, such as Bangladesh, Chile, Ghana, Mauritius, Rwanda and Tunisia. [3]

References

- [1] UIS FACT SHEET DECEMBER 2012, No.21
<http://www.uis.unesco.org/Library/Documents/fs21-human-resources-research-development-r-d-science-technology-2012-en.pdf>
- [2] Laudeline Auriol, OECD CAREERS OF DOCTORATE HOLDERS: EMPLOYMENT AND MOBILITY PATTERNS
<http://www.uis.unesco.org/ScienceTechnology/Documents/44893058.pdf>
UIS Fact Sheet, October 2009, No.2 A Global Perspective on Research and Development
<http://www.uis.unesco.org/template/pdf/S&T/BulletinNo2EN.pdf>
- [3] Human development Report 2013. The Rise of the South: Human Progress in a Diverse World
<http://www.uis.unesco.org/Library/Documents/human-development-report-2013-education-en.pdf>



THE ROLE OF INQUIRY SCIENCE LAB WITHIN SCIENCE CENTRE

Marián Kireš, Mária Nováková

*Institute of Physics, Faculty of Science,
University of P.J.Šafárik, Košice, Slovakia
marian.kires@upjs.sk,
maria.novakova@student.upjs.sk*

Abstract. *In the paper the authors consider the way selected centres of science popularization work from the point of view of possibilities of using the exhibits by visitors. The key aim of the popularization exhibition is to raise interest, increase motivation and draw visitor's attention to using scientific knowledge in both technical practice and everyday life. From the point of view of education, however, the usage of the attractive exhibits potential is limited. Based on their experience in organizing several popularization events the authors present an idea of developing pupils' cognitive processes by means of experiments incorporated into inquiry science lab. The concept of the laboratory as part of Steel Park centre for science and technology popularization in Košice is introduced. In selected tasks the authors point at different levels of inquiry oriented activities viable with a group of pupils of different age. The designed tasks connect with syllabuses and are aimed at developing different elements of scientific literacy of pupils.*

Keywords: inquiry, popularization, science centre.

1. Introduction

A lot of science centres, exploratories and museums [1] have been established in effort to promote science and technology in society, among children and young people. They are basically institutions that have prepared a series of scientific experiments, observations, games and similar attractions working on a selected phenomenon. A surprising effect, unexpected behavior or inexplicable phenomenon that are supposed to raise curiosity and desire to discover

in a visitor are offered to them as a rule. The exhibits are usually prepared in such a way that it is possible to carry out observation with them repeatedly without help of an instructor.

A visitor usually perceives the activities as a game, the aim of which is to watch a selected phenomenon. Its essence is explained in the text by the exhibit. It is amazing to watch the excitement, enthusiasm and happiness from controlling the exhibits. They certainly fulfil their primary function of winning the interest and cause a long-lasting experience.

Visitors of popularization centres are often groups of school children on a school excursion. From teacher's point of view it would be surely welcome if besides motivation the excursion had an educational size and if it could be possible to use it to complement subject matter or to develop skills acquisition of which school does not have appropriate conditions for. This requirement made us think of using the enormous motivation potential of the exhibits and unusual observations in educational activities carried out directly in a popularization centre.

2. Steel Park Inquiry Science Lab invention

The classical exhibits of the visitor part of the Steel Park [2] predominantly focused on presentation of interesting scientific, technical and technological solutions used in steel and steel products production. Our aim is to raise excitement and interest in a visitor and to create a positive attitude to science and technology. The information mediated by exhibits is processed mainly on the level of remembering and on the basis of experience-based observation.

In every aspect of human activity, however, there are key concepts and phenomena that require thorough understanding their substance. Understanding key concepts and processes is possible to be achieved mainly by pupil's own cognitive activity. Using prior (primary) knowledge acquired by a pupil in the process of school education, extracurricular or free time activities is important.

Pupil's cognitive activity should be guided and monitored by means of immediate feedback and the result of the activity should be evaluated based on comparison with primary knowledge.

Inquiry Science Lab activities use constructivist approaches and different levels of inquiry-based methods. A certain part of visitors will consist of

organized groups accompanied by a pedagogical worker (teacher) and as a rule connected with school activities (trip, excursion). Their number is strongly dependent on the teacher's (school director's) belief that the visit is beneficial for education by complementing, widening and enriching it.

A parent (grandparent) with a child, two or three friends may be motivated towards the visit by the very possibility of independent investigation, discovery and consequently also of understanding principles things work based on. Primary knowledge, experience and interest in certain topics will be strongly used here.

3. How it will work

The focus of Inquiry Lab topics follows ISCED2, ISCED 3A state educational programme, chapter: Man and nature. Ten topics are elaborated in total that can be used for both elementary and secondary school pupils. Within each topic there are four different tasks, which can be performed on observation or inquiry level each.

Inquiry Science Lab represents four independent workplaces suitable for work of 3-4-member groups, maximum 16 visitors in total. Working out one topic requires 45 minutes. If the tasks involve observation, the groups take it in turns to work at all four workplaces. If inquiry is involved, each group deals with one task and at the end they inform one another about the findings. The groups are guided by a Steel Park Inquiry Science Lab lecturer (a university student, ideally a pre-service teacher).

Within each topic four different activities are elaborated, each of them being prepared for two levels:

- Observation of the phenomenon and its discovery,
- Investigation of the phenomenon and its understanding.

Observation means that a visitor has a simple instruction available as to what to do with the exhibit, what to notice, there are questions to think about as well as a brief description of the observed phenomenon. Investigation represents a series of activities by which a visitor discovers properties of the objects, gets to know their behavior, finds out their dependence... we want them to understand the essence of the investigated phenomenon.

Visitor leaves each activity with their scientific notes recorded in prepared worksheets.

Organized groups make a fixed reservation for a currently offered topic by filling out an electronic form. The reservation is due to be made at least two days beforehand. The topics are changed monthly during a school year. During holidays the most attractive topics will be offered (the ones most wanted during a school year). If there is no prior reservation (the date is free), visitors are offered to carry out observation in Inquiry Science Lab for the minimum of 3 groups (2-4 visitors).

In the room there are four independent workplaces installed. Each of them has a computer with measuring equipment available and is connected to a projection area and the Internet. An interactive data projector connected to the lecturer's computer is used for guiding the activity. A lecturer can show any workplace monitor on the projection area. Storage area of each workplace can accommodate equipment for 10 topics (each topic with 4 tasks).

4. Inquiry activities

Our aim is that the educational activities of Inquiry science lab could appropriately complement and cohere with the exhibits of Steel Park – creative factory. Therefore we have selected topics of such areas as e.g. Green energy, How JO- JO Works, Optical illusions, or Low energy house. Each topic is presented by four different activities. We present three topics and selected activities as an example.

I. Green energy

1. Energy from the Sun
2. Hydrogen – fuel of the future
3. Wind energy
4. Peltier cell

The activity Hydrogen – fuel of the future can be carried out as bounded or guided inquiry, as was described in more details in project Establish [3]. Students study the text about the basic principles of the fuel cell technology, PEM electrolyzers and possible solutions for storage of hydrogen. The next part is focused on measuring energy efficiency of PEM electrolyzer. It can be carried out as guided inquiry following the instructions in the worksheet. Finally, based on their own results students can calculate the energy

efficiency of the electrolyzer and compare it with the theoretical one. Last part of activity is focused on measuring of fuel cell hydrogen consumption and energy efficiency. This activity can be continued as an interactive discussion between lecturer and visitors.

II. To make bodies turn - we investigate yo-yo.

1. How to make it turn around properly
2. We are rolling and rolling
3. Persistent in rolling, lazy in setting to it
4. How yo-yo works

The concrete experience with the yo-yo wheel motion can become a good starting point for the student understanding of the concepts of rotational motion [4]. In order to help in better understanding of the rotational motion concepts there is an inquiry based laboratory work designed for visitors. The aim is to study the rotational and translational motion of the yo-yo toy in order to describe and analyze the kinematics and dynamics of this kind of motion. Visitors measure and analyze the position, velocity and acceleration of the moving different objects with the help of computer based measurements via Coach system.

III. Low energy house

1. The effect of sunlight on the temperature inside house
2. The isolation properties of different materials
3. Build and use home-made radiometers
4. Hot air balloon power by candle

We would like to investigate the hot air balloons basic scientific principles, warmer air rises in cooler air. The balloon has to be so large as it takes such a large amount of heated air to lift it off the ground. To help keep the balloon in the air and rising, hot air needs to be propelled upwards into the balloon using the candle burners. The task is to measure how much thermal energy is needed for the hot air balloon rising.

Our aim in inquiry-based activities is to use four groups of pupils to investigate seemingly independent issues. A laboratory presenter makes a motivating introduction to the issue and opens a short discussion based on pupils' primary

knowledge. Tasks division is agreed on, each participant knowing their task as well as the tasks of others. Task solving is guided within supervised discovery by means of worksheets. At the end there is time set aside for presentation of results of each group and summary. Emphasis is put on the ability to present arguments and justify one's results.

5. Pre-service physics teacher training

The educational activities are guided by pre-service teachers who this way do their training. Because each month of a school year there will be presented a different topic, we will follow the results of the questionnaires evaluating its success. In the questionnaire the focus is on finding out the level of understanding the issue, ability to give arguments and evaluate one's own work. Pupils will participate in the questionnaires by means of voice system connected to the ticket. It will be thus possible to follow an individual pupil in their repeated participation in the educational activities as well. Pre-service teachers will benefit from precious experience in carrying out inquiry-based activities and test their ability to evaluate a scientific experiment. By repeating carrying out such activities they will be able to improve their approach and develop their pedagogical skills.

6. Acknowledgement

This work is the result of the national project Science on Stage Slovakia, under the support of the Slovak Research and Development Agency grant agreement: APVV-LPP-0223-09 and international 7FP project ESTABLISH (European Union's Seventh Framework Programme FP7/2007-2013 under grant agreement n° 244749)

7. References

- [1] Universum Göteborg, Sweden
<http://www.universeum.se>, Science Museum London, Great Britain
<http://www.sciencemuseum.org.uk>, Cité des Sciences et de l'industrie Paris, France
<http://www.cite-sciences.fr>, Deutsches Museum Munich, Germany
<http://www.deutsches-museum.de>
- [2] www.steelpark.sk
- [3] Establish project, available on <
<http://www.establish-fp7.eu>>

- [4] Pecori, B., Torzo, G. (1998): The Maxwell Wheel Investigated with MBL, The Physics Teacher, 6, 362-366



NABOJ - INTERNATIONAL MATHEMATICAL COMPETITION FOR HIGH SCHOOL STUDENTS

Róbert Hajduk

*Institute of Mathematics, Faculty of Science, P.
J. Šafárik University,
Košice, Slovakia
robert.hajduk@upjs.sk, hajduk@strom.sk*

Abstract. *Náboj is an international mathematical competition designed for teams of five high-school students that represent their schools. It is live competition which is place on 4 places (Košice, Bratislava, Opava Praha) in same time. The competition lasts 120 minutes during which the teams are trying to solve as many given problems as possible.*

It is not just a direct application of the knowledge the students already have had. The tasks require a certain amount of inventiveness and ingenuity. In the poster we show full scheme of this competition with sample of mathematical problems.

Keywords. competition, popularization of mathematics, non-formal education

1. Introduction

Mathematics in the teaching process belongs to the subject that is difficult for students. Many of students need stimuli to motivate to understand it. Using the less formal form of the teaching process in the school is the problem. Teachers don't have place and time for using these methods in the class. The contest is one of the suitable forms of learning and personal development. We choose the form of competition, which is still verified on math camps.

2. History

History of this competition extends to 1976,

when first correspondence mathematical seminar was created in Kosice [1].

The main characteristic of the seminar was that it was based on an experiments and discoveries in mathematics made by students themselves, using mathematical games and collective competitiveness. In the next years, correspondence seminars for secondary school students were created in Prague, Bratislava and other cities. Later the seminars for younger students were created as well. Currently in Slovakia there are several of mathematical correspondent seminars operating in Košice, Žilina and Bratislava. Naboj was a one of the mathematical activities which were created in the mathematical camps. This name is arising as shortcut from the notice board fight (NÁstenkový BOJ). At the beginning it was as the individual competition in the solution of mathematical tasks which were public on the notice board. Later was a similar idea use to the team competition in solving mathematical tasks. Currently, there are several competitions with the same ideas as competition on mathematical camps. One of them is an international mathematical competition, and it is called Náboj. Participate on them high schools from Slovakia and Czech Republic. Moreover in Kosice there are a three contest with the same idea. They are

- Košický Matboj – intended for students 1st – 4th year of high schools and last four years of eight year secondary schools.
- Lomihlav – intended for students 7th - 9th year of primary school and the 2nd, 3rd and 4th class of eight year secondary schools,
- Mamut – intended for students 4th - 6th year of primary school and the 1st class of eight year secondary schools.

3. Náboj

Náboj is an international mathematical competition designed for teams of five high school students that represent their schools. The competition lasts 120 minutes during which the teams are trying to solve as many given problems as possible.

At the beginning of the competition each team receives six problems. As soon as the team correctly solves any of the problems it receives a new one. The solutions of the problems are usually numerical. The team that solves most problems correctly in the given time limit wins.

Difficulty of the problems is appropriate both for

students inexperienced in mathematical competitions and for students who have already succeeded in Mathematical Olympiad. This is achieved by arranging the problems in order of their perceived difficulty. Problems in Náboj differ considerably from the routine school exercises which usually require only direct application of a given method: the Náboj problems require certain amount of inventiveness and ingenuity. Success in the competition does not depend on the individual abilities of the team members only but also on their efficient cooperation. Apart from enhancing imagination and logical reasoning our goal is to attract people to the endless beauty hidden in mathematics.

Náboj 2013 takes place simultaneously in Prague, Bratislava, Opava and Košice. In each of these sites there will be a local ranking of individual teams. Students will also be able to compare their performance in the national and international ranking. The teams will also be able to check their current ranking during the competition.

Teams compete in two categories, Juniors and Seniors. The Junior category is open only for teams with all members attending first or second grade of a 4-year high school (or a corresponding grade in 5- or 8-year high school). The Senior category is open to any team consisting of high school students.

3. Acknowledgements

Mathematical competitions for students of high schools and students of primary and secondary schools are supported by the grant APVV LPP-0057-09 Developing talent through correspondence seminars and competitions.

4. References

- [1] Gavalec M, Mihók P, Mihalíková B. Correspondence math seminar, Krajský dom pionierov a mládeže v Košiciach, 1986. [in Slovak]
- [2] NABOJ – International math competition. <http://naboj.org/en/> [visited 15-May-2013]



AN ANNUAL HANDS-ON SCIENCE COMPETITION

Salvador Rodríguez¹, Raquel Vergara¹
Benito V. Dorrió²

¹I.E.S. Escuelas Proval, Nigrán, Spain

²University of Vigo, Spain

salvador@edu.xunta.es,

rvergara@edu.xunta.es, bvazquez@uvigo.es

Abstract. Throughout the whole academic year, a scientific competition was held which was a combination of typical competitions and displays in education centres. A series of hands-on modules were selected and placed in the centre's hall for a month. Anyone could interact with them at any time. As an incentive to involve participants, a competition was organised in which they had to solve simple challenges linked to the concepts associated with each of the activities. This communication includes the proposal's design, characteristics and most salient results.

Keywords. hands-on activities, informal learning, science competition, motivation.

1. Introduction

Interest in science is directly related to explicit experience of it, an understanding of it and the perception of the influence it has on everyday life, progress or improvements in the standard of living. This process should start at an early age and seek to increase interest in such contents in order to foster a vocation for science or technology. Since the 2004-2005 academic year, the I.E.S. Escuelas Proval has held a Science Week with these aims [1]. Essentially, the activity recreates a small interactive museum inside the educational environment (Figure 1) with experimental modules related to theoretical classroom material [2]. This experience led us to organize the annual competition in the 2011-2012 academic year, which aimed to awaken ingenuity and personalize educational experiences. The proposal was based on the combination of typical school competitions [3] and displays in education centres [4]. A series of modules were selected as a permanent display that allowed students to interact voluntarily at any time. As an incentive to use it, a competition was devised in which participants had to solve simple challenges related to the concepts

associated with each of the activities in order to gain a prize if the challenges were successfully met. This communication explains the characteristics and the most salient results.



Figure 1. Various images of the I.E.S. Escuelas Proval Science Week

2. Science in the corridor

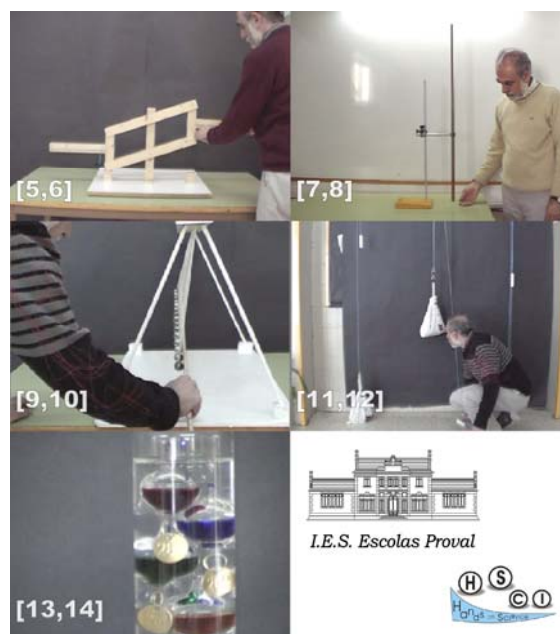

Figure 2. Modules employed for the first annual hands-on science competition at I.E.S. Escuelas Proval

There is abundant evidence for the advantages of involving students in additional activities for

inquiry. It is a way of giving full meaning to the scientific contents given in the classroom by means of experimental tasks that are informal in nature. As part of a broader process, a proposal for learning using the structure of an annual competition was organized at the I.E.S. Escolas Proval in Nigrán, Pontevedra, Spain. The clear aim was to boost interest and motivation for Science and science topics, assuming that young learners are receptive to hands-on experiments using simple devices. With the experience built up over seven previous Science Weeks, it was decided to hold a competition that would be inclusive, fun and different from other proposals, which was based on answering questions related to the handling of five interactive modules that had been selected and designed to interest pupils independently. Each module was located in the Centre's entrance hall for a month at some point during the year and provided the chance to learn physical concepts in a non-classroom situation at break times. Each experimental proposal was accompanied by a panel which gave a brief presentation of basic operation and then proposed questions that required hands-on use of the elements making up the system and additional bibliography that could be consulted. The responses from people taking an interest were either posted in a box next to the experimental module or sent by email.

Below the five selected modules are presented, showing the introductory text used for them and the proposed questions (Figure 2):

Balances [5,6]

Presentation:

Here, you have two sets of scales and three weights (two the same and one different). Start by using the "simple" scales. Try weighing with them by putting a weight on each arm at different distances from the centre. What do you observe? Then try weighing with the other scales, also by putting the weights at different distances from the centre of the scales. Note if there is any difference between these scales and the first ones.

Questions:

- To make the simple scales balance, with equal weights; do you have to put them at an equal distance (more or less) from the centre of the arm?
- To make the other scales balance; do the weights have to be the same distance from the central axis of the scales?
- What are the "complicated" scales

called?

- Do the "complicated" scales have any way to be balanced using the different weights?
- Give a physical explanation of why these two scales behave so differently.

Induced currents [7,8]

Presentation:

One pipe is made of plastic, the other of copper. The magnet does not attract either the plastic one or the copper one. You can check this.

Drop the magnet down each pipe.

Questions:

- Which pipe does the magnet fall through faster?
- Why does it fall faster through one than the other?

Coupled pendulums [9,10]

Presentations:

Move all the pendulums together with the aid of the bar. Release the bar quickly and observe how the pendulums move.

Questions:

- Which pendulum takes the longest to make one complete oscillation?
- Which takes the least time?
- Count the number of complete oscillations made by the longest pendulum and the number by the next one to it. What do you observe? Does the same thing happen between each pendulum and the next one? Check this with several of them.

Pulley systems [11,12]

Presentation: Lift the sandbags by pulling on the rope with the white handle, starting with the pulley on the left. All three sacks weigh the same. Notice what the pulleys are like and how they have been combined.

Questions:

- With the pulley on the left, is the force you use to pull on the rope equal to, greater than or less than the weight of the sack?
- With the pulley on the right, how much force do you use to lift the sack compared to its weight: half; a quarter; an eighth?
- So, you will now notice that with the pulley in the middle you have to pull the rope with less force than the weight of the sack. In that case, "who" provides the force that is "missing" to lift the sack?

Galileo Thermometer [13,14]

Presentation: The apparatus you can see here is a thermometer, although it doesn't look like one. It was invented several centuries ago.

Questions:

- What is this thermometer called?
- What temperature is the thermometer showing at the moment?
- How does this thermometer work? What is the mechanism? That is to say, on what principle of physics or chemistry is it based?

3. Results and conclusions

About thirty people completed the questions over the year during this first event, mainly pupils from the 3rd and 4th year of Compulsory Secondary Education and the 1st and 2nd year of the Baccalaureate. That said, hands-on use of the display elements was widespread by teachers, other pupils and service staff (Fig. 3). The winners received an I.T. prize (a tablet, a touch MP5, a digital camera and several flash drives) and a certificate.



Figure 3. Some pupils handling one of the permanent display elements

All the participants were asked to hand in a survey on the activities, which evaluated the degree of satisfaction, difficulty, and information available for each one on a scale, where 0 was none, 5 was medium and 10 was a lot (Fig. 4). In general the activity was assessed as useful, the level of comprehension was high and they had

little difficulty in finding information relative to the tasks. Finally, they were asked about their degree of satisfaction with the activity in general and whether they would like it to be held next academic year. Using the same scale, the former question received an average response of 9.2 and the latter an average of 9.4.

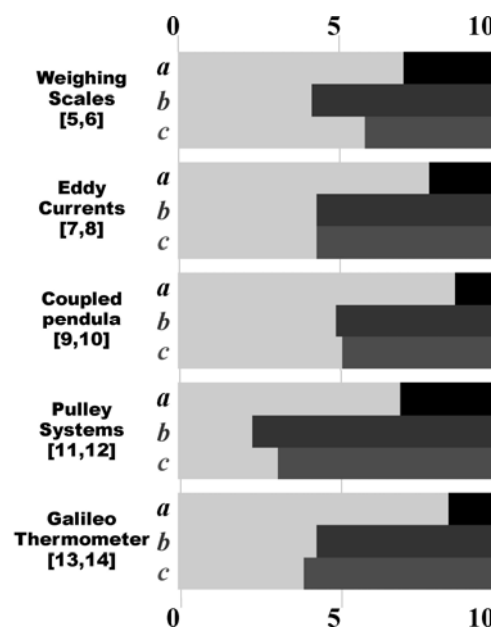

Figure 4. Results of the survey. a: Did you like this experience?; b: Did you find it difficult to understand?; c: Did you find it difficult to get information about it?

4. Acknowledgements

This communication was drawn in the frames of the activities of the PRI-SCI-NET project supported by the European Union Seventh Framework Programme (FP7/2007-2013, grant agreement no. 266647).

5. References

- [1] Dorrío BV, Rodríguez S, Fernández J, Ansín JA y Lago A. Ciencias en las manos: Aprendizaje informal. Alambique. Didáctica de las Ciencias Experimentales 2007; 52: 107-116.
- [2] Dorrío, BV. Museos interactivos en la escuela. Revista Gallega de Educación 2006; 35: 20-22
- [3] Jones G.Y. (1984) Another physics competition, The Physics Teacher 1984; 22: 565-568.
- [4] Campbell J. Canterbury's physics display facility. The Physics Teacher 1989; 27:

- 526-529.
- [5] <https://www.youtube.com/watch?v=rB6uWNQAjeg> [05/13/2013]
- [6] Chagnon P. The Roberval balance. *The Physics Teacher* 1992; 30: 238.
- [7] <https://www.youtube.com/watch?v=mVMrjWJ2gN0> [05/13/2013]
- [8] Ruiz MJ. Lenz's Law Magic Trick. *The Physics Teacher* 2006; 44: 96.
- [9] <https://www.youtube.com/watch?v=qjhJj8r0l-M> [05/13/2013]
- [10] Flaten J, Cooper R. Improving Upon Mach's Wave Machines to Demonstrate Traveling Waves. *The Physics Teacher* 2005; 43: 304-307
- [11] <https://www.youtube.com/watch?v=5XrwGB8ZsOk> [05/13/2013]
- [12] Gluck P. The Pulley: A Parable of Effort and Reward. *The Physics Teacher* 2012; 50: 488.
- [13] <https://www.youtube.com/watch?v=ENjkgmHFbt4> [05/13/2013]
- [14] Featonby D. Toys and physics. *Physics Education* 2005; 40: 537-543.



DEVELOPMENT OF POSITIVE ATTITUDES TOWARDS SCIENCE AT THE CHILDREN SUMMER CAMP

**Jana Raganová, Martin Hruška,
Mária Beniačiková, Katarína Krišková**
*Faculty of Natural Sciences, Matej Bel
University Banská Bystrica,
Slovakia*

janka.raganova@umb.sk, martin.hruska@umb.sk, maria.beniackikova@gmail.com, katarina.kri@gmail.com

Abstract. *This article describes one of the activities organised by scientists from the Faculty of Natural Sciences, Matej Bel University Banská Bystrica (SK), that intent to promote science to public – a children summer camp.*

The summer camp with a title Young scientist was held directly in the Faculty building in July 2012. Children aged from 6 to 15 spent one week of their summer vacations at physics, chemistry, biology and geography laboratories investigating interesting science phenomena.

The article focuses at the physics programme that included themes of sound, motion, electricity and magnetism. It was set up with an aim to educate as well as to entertain the participants through a wide range of hands-on activities: attractive demonstrations, „magic” experiments, computer-supported experiments, competitions, hand-making toys etc. Selected activities that have gained the greatest children’s interest and engagement are introduced in the article and the results of this popularisation activity are discussed.

Keywords. Public science education, edutainment, primary and lower secondary education, physics experiments, sound, motion, electricity and magnetism.

1. Introduction

Growing decrease of young people interest to study physics and chemistry and become teachers of these subjects, which is in contradiction with needs of technologically developed society, has reffected in strong efforts of educational institutions to promote sciences to

school children as well as to general public by an attractive way. A lot of examples of good practise in this area can be seen in Slovakia and within other European countries [1], [2], [3], [4], [5]. It is strongly felt that various forms of non-formal science education should not only educate their participants, but entertainment is a very important part of them [6]. Non-formal educational activities have become an important way of leisure time spending, especially in eyes of parents of school children.

Teacher trainers and scientists from the Faculty of Natural Sciences, Matej Bel University Banská Bystrica continuously seek for new attractive ways how to present science to school children and general public as well. Besides the traditional events such as “The day of the open doors” or “Science week” focused on upper secondary school students we try to organise educational activities targeting the youngest learners. One of them is summer Children’s university, which attracts children but provides rather passive way of learning – children are supposed less or more only to sit and to listen to a set of lectures.

In summer 2012 we tried to offer to parents an alternative vacation activity for their children – a summer camp “Young scientist” that would connect leisure activities with active learning in sciences. The parents’ reaction was positive and we recruited a sufficient number of participants to organise two one-week runs of the camp.

The participants were divided into two age groups. Pupils of the primary education level (6 to 10 years old) created one group. The second group involved pupils of the lower secondary education (11 to 15 years old). The programme of the both age groups consisted of two three-hour sessions for each of science disciplines: physics, biology, geography and chemistry.

We will concentrate on a description of the physics programme of the both age groups.

2. Learning by playing at a primary education group

The group of the youngest children represented a great challenge to the organisers. As university teachers and secondary school teacher trainers we have a lack of possibilities to work with such age group. Moreover, these children have no physics lessons at school, so they have almost no formal knowledge from physics.

So as to set up an appropriate programme to this group we tried to select physics themes that

would enable children engagement and had not required any previous knowledge. We have decided for two main themes – sound and motion. The first of them allowed to build upon a frequent children’s hobby – playing musical instruments. Second one enabled to use natural skittiness and movements of children.

Each of the sessions consisted of various activities. First of all it was a set of attractive hands-on experiments and demonstrations, that we had chosen with an aim to illustrate basic properties of sound and laws of motion. The sound topic included for example playing the goblet harp, singing bottles, demonstration of waves with Julius wave machine and with a rubber hosepipe, visualisation of sound on the Chladni’s plate or moving a paper butterfly with a sound cannon (Fig. 1).



Figure 1. *Playing with sound waves*

Simple investigations of children voices with the use of the computer and a sound sensor was included as well (Fig. 2).

The laws of motion were illustrated and explained to children using models with children’s direct involvement (Fig. 3) and demonstrations of different kinds of rockets – a balloon rocket, a denatured alcohol rocket, and a vinegar rocket. Then we encouraged children to make and to test small vinegar rockets by themselves.

Children created also other toys from simple materials, such as paper airplanes, telephones, drinking straw flutes, paper flowers etc., that were used in further activities – investigations, games and competitions (Fig. 4). Children appreciated to have a chance to take their products home and to show them to parents as well.



Figure 2. Investigations of kids' voices



Figure 3. Demonstration of laws of motion

A very popular part of physics sessions had the subtitle "Hókus Pokus" (Magic experiments). Each pupil had to learn a "magic" trick based on physics. At the end of the session they promoted their tricks in front of the others. Children were fascinated that they were able to hold the water in the cup upside down, pasting the balloon on the ceiling without using glue, move a paper figure or a large broom with a "magic" stick or to "levitate".

Children were very happy to take part in a set of outdoor activities, where they could play with bubbles, try spinning cups or a bin with water or to observe Segner's while (Fig.5). A surprise in the form of Cola geyser finished the exciting physics session.



Figure 4. Whose plane is the best?



Figure 5. Outdoor physics activities

3. Lower secondary education group

Physics sessions of the oldest group enabled children to discover and investigate several interesting phenomena, play games and puzzling problems from various areas of physics. Children divided into cooperating sub-groups worked in the laboratory of mechanics, molecular physics and thermodynamics and in the laboratory of electronics.

The first set of their activities consisted of various computer assisted experiments. They investigated motions with an ultrasound sensor, tried to gain the highest temperature by their own

activity without using of fire or hot water and investigated temperature changes in a mixture of ice, water and salt (Fig. 6).



Figure 6. Investigation of cooling mixture

They were also encouraged to solve a practical problem – to build a paper bridge that was able to hold a toy car. During the “building” the bridge pupils were talking about forces that had impacted on the toy car and the piece of paper.

The final activities of the first physics session involved testing of children’s ears and eyes. Children could measure a range of sound frequencies that they were able to hear, visualised and analysed their voices. With the use of a school spectrometer children decomposed and studied light from various sources.

The second physics session was held in the laboratory of electricity and electronics where children conducted a set of experiments somehow connected to everyday life.

At the beginning pupils had to solve a puzzling problem. Their task was to set up a homopolar motor with the use of storage batteries, a copper wire, a neodymium magnet and a screw.

The next task was to construct a model of a wind turbine and to light a bulb using a photoelectric cell.

Children could also observe and investigated characteristics of an inducting cooker. They tried to heat water using different pots and came to results that had surprised them. We also demonstrated the inducting cooker principle by lighting different bulbs with the cooker (Fig. 7).



Figure 7. Lighting of bulbs with an inducting cooker

A competition of groups was a final physics activity. Children had to thread a copper ring through a curved steel bar without a contact (Fig. 8). The activity tested patience and cooperative skills of children and made fun to them.

4. Conclusion

The summer camp „Young scientist” represented a new experience not only to participated children, but also to the involved scientists. Children provided us spontaneously with an immediate feedback. We could see a level of their motivation and engagement in each of the prepared activities and were pleased to get positive reactions of children.

A wonderful acceptance of the physics programmes by the both age groups was proved also during interviewing the participants in the end of each week by a main camp organiser.

It was proved that children liked the most the activities where they were allowed to touch and try everything by themselves. They liked to be active “young scientists”, they liked competitions and games.

Of course, we had to cope with several problems that had occurred. Surprisingly they were not connected with initially expected difficulties of “translations” of physics knowledge to so young

children. It seemed that children understood us well. We could even discuss rather difficult problems with them, for example a vertically circulated bin of water. The problems occurred in other areas, for example in competitions. Children took them very seriously. It was not a play for them, but an important event. Some girls even started to cry where their paper plane fell down too quickly...



Figure 8. Competition of groups

The programme also required children to be fit. We could see that for some of them it was too rich set of activities. They were overfeeding with new experience – and very tired – in the end of the week.

We have known both from the children's and parents' feedback that children liked to be in our summer camp very much. We also wonder if they have learned anything. A positive answer came during the following popularisation event organised in Banská Bystrica – Researchers night. Many children brought their parents to physics stands presented at this event, clearly and loudly demonstrating their attitudes and knowledge that they had gained in Young scientist summer camp.

The physics programme of the children summer camp was prepared in collaboration of two physics teacher trainers and two students – future physics teachers. This fruitful collaboration has represented another positive outcome of the activity. We hope to have a chance to build upon the experience that we have gained and to continue with organising the camp also in next summer.

5. Acknowledgements

The support received under project KEGA 022UMB-4/2012 "The use of new methods and forms in training of physics teachers and their pupils with emphases on the development of their competencies in science inquiry" is gratefully acknowledged.

6. References

- [1] Chalupková S, Demkanin P. Students' Hobbies as a Context for Physics Teaching. In: *Scientia in education* 2011; 2(1): p. 15-22.
- [2] Šterbáková K. Elementárne pokusy a ich konkrétna aplikácia v záujmovej činnosti. In: Šebeň V et al, eds. *Technológie vzdelávania v príprave učiteľov prírodovedných a technických predmetov*. Prešov: Katedra FMT, FHPV PU v Prešove, KEGA č. 3/7083/09, KEGA č. 114-029PU-4/2010; 2011, p. 364-369.
- [3] Valovičová L, Jakab I, Štubňa M. Realizácia projektového vyučovania v tábore Prírodovedná ochutnávka. In: Šebeň V et al, eds: *Technológie vzdelávania v príprave učiteľov prírodovedných a technických predmetov*. Prešov: Katedra FMT, FHPV PU v Prešove, KEGA č. 3/7083/09, KEGA č. 114-029PU-4/2010; 2011, p. 386-390.
- [4] Spodniaková Pfefferová M. Fyzika okolo nás – online databáza simulácií. In: *Tvorivý učiteľ fyziky IV*. Košice: *Equilibria*; 2011, p. 213-219.
- [5] Nováková M, Kireš M. Inovatívne námety vo vyučovaní fyziky. In: Šebeň V et al, eds.: *Technológie vzdelávania v príprave učiteľov prírodovedných a technických predmetov*. Prešov: Katedra FMT, FHPV PU v Prešove, KEGA č. 3/7083/09, KEGA č. 114-029PU-4/2010; 2011, p. 215-219.
- [6] Walton R. Veda v domácnosti a fyzika v kuchyni: popularizácia vedy v spoločnosti. In: Raganová J, Monoszová G, Murin M, eds: *Brána vedy otvorená*. Banská Bystrica: *Fakulta prírodných vied UMB, Projekt APVV č. LPP-0028-06 Brána vedy otvorená*; 2009, p. 185-191



POPULARISATION OF CHEMISTRY AMONG THE INHABITANTS OF GDAŃSK REGION

Malgorzata Czaja, Bożena Karawajczyk,
Marek Kwiatkowski

University of Gdańsk, Faculty of Chemistry,
Gdańsk, Poland

viola@chem.univ.gda.pl,
karawana@chem.univ.gda.pl,
kwiatm@chem.univ.gda.pl

Abstract. *Baltic Science Festival, held annually in Gdańsk, is a non-profit event whose main goal is to popularise science among the inhabitants of the region in the attractive and comprehensible form. The event is addressed primarily to young people - the students of primary and secondary schools. The chemistry workshops, organised by the students of Faculty of Chemistry, University of Gdańsk, are the important element of the Festival. During the workshops, the visiting students have unique opportunity to explore the impact on chemistry on the environment by themselves. High popularity of the workshops may affect the general attitude of young people towards chemistry (and science in general) and hopefully attract some of them to studying natural sciences in the future.*

Keywords. Baltic Science Festival, chemistry workshops, popularisation of chemistry

1. Introduction

Educated society is the foundation of the well-being and development of contemporary world. Education is one of the most important areas in politics of European Union [1,2]. In particular, the role of science, research and technology development in maintaining and improving the standards of everyday life should be well known and understood. Unfortunately, this is not always the case. The most prominent example is the unfavourable image of chemistry, which is commonly associated with rather negative aspects of human activity: pollution of the environment, synthetic food additives, dangerous chemicals in the household, etc. Chemistry is not popular among the school students too – the recent survey [3] revealed that most of them regard chemistry as difficult and boring, and that

they are generally not interested in studying chemistry at the university in the future.

Popularisation of chemistry may change these common opinions. It should be directed to the possibly broad range of ages and professions. School students, to satisfy child's natural curiosity, to show that chemistry is neither boring nor difficult, that exploring chemistry can be a fascinating activity. Adults, to overcome stereotypes embedded by media and advertisements, to provoke intellectual reflection how chemistry affects the surrounding world and everyday life. Seniors, to offer them opportunity to spend free time on broadening their horizons. Even scientists, non-chemists, to inspire new angles of their research.

2. Baltic Science Festival

Seeing the importance of popularizing science, the universities from the Gdańsk region, together with other academic and cultural institutions, organise every year an event called Baltic Science Festival. The main goal of the Festival is to popularise science among the inhabitants of the region in attractive and comprehensible form, to show the most spectacular scientific achievements and to demonstrate the role of science in the development of the society. The Festival is a non-profit event and attracts every year crowds of visitors from Gdańsk area. Though everybody can participate, the Festival is addressed primarily to young people - the students of primary and secondary schools, even the preschoolers. For them, it is a good opportunity to broaden their interests that may decide about the direction of their education choices in the future.

3. Chemistry workshops

Chemistry workshops, organised by the students and lecturers of Faculty of Chemistry, University of Gdańsk, are the important element of the Festival. Particularly, the students trained to be future chemistry teachers are actively engaged in preparing and running the workshops. The participants, generally students of secondary schools, have no experience to work by themselves in the chemical laboratory, so they first get familiar with the properties and safe handling of chemicals. The safety to own health and to the health of other people working in the laboratory, as well as the concern about the environmental impact of the chemicals are

stressed at this point. Students run the experiments by themselves, working in small groups (two or three persons) under the supervision of trained leaders from the university. The leader's role is to introduce students to the problem and then to guide them through the activity by asking questions, encouraging discussion and formulation of hypotheses, indicating relevant pieces of information. Every idea of participants is paid due attention, discussed and commented on. The important part of the workshop is the presentation of the results and discussion on the conclusions.

Thematically, the workshops are divided to several stands:

- *"Soil"*. Students measure the pH of the samples of soil, then study the effect of acid rain and liming of soil. They prepare a model of sand filter that illustrates self-purification of sewage waste passing through the layers of soil.
- *"Air"*. Students compare the behaviour of air and carbon dioxide on heating, drawing conclusions about the role of CO₂ in global warming.
- *"You can care about the environment every day"*. Students measure and calculate the amount and cost of water coming out from a leaking tap. They compare the cleaning effects of table salt, sand and chemical detergents on washing dishes. They prepare a sample of biodegradable polymer, this way learning about more environment-friendly packaging materials.

The stands are equipped with posters, explaining the problems in details and containing many other interesting information on the subject. Completing the activity at every stand, students take part in a competition, where prizes are also of environment-friendly character: natural wood pencils, notebooks from the recycled paper, sweets with no colorants and preservatives added.

4. Conclusions

Invariable popularity of the workshops and positive opinions expressed by the participants in questionnaires indicate that they have become the important element of the Baltic Science Festival, adding to the popularization of science among the inhabitants of Gdańsk region. Organisers of the workshop hope that due to the attractive character of the proposed activities, the

negative image of chemistry will gradually change and that more young people will decide to study chemistry in the future.



*School students at chemistry workshops an
Baltic Science Festival 2012*

8. Acknowledgements

The authors acknowledge the support from the grant 530-8140-D198-12

9. References

- [1] Home page of "Centrum Informacji Europejskiej", www.cie.gov.pl [visited 17-May-2013]
- [2] Kraśniewski A. "Proces Boloński: dokąd zmierza europejskie szkolnictwo wyższe?", Warszawa 2003
- [3] Czaja M., Kwiatkowski M., Kuczyńska E., "Uczniowie o naukach przyrodniczych", Research In Didactics of the Science, Kraków 2008 (ISBN 978-83-7271-519-7) p. 75-78.



STATISTICAL ANALYSIS ON THREE HANDS-ON SCIENCE NATIONAL SCIENCE FAIRS IN PORTUGAL

Zita Esteves, Manuel F. M. Costa

*Departamento de Física, Universidade do
Minho, Braga, Portugal.
zita.esteves@gmail.com,
mfcosta@fisica.uminho.pt*

Abstract. *Three years ago the Science Fair “Hands-on Science” was established with focus on upper basic and high school levels. In April 2013 the third edition of the hands-on science network science fair was organized, in Viana do Castelo, Portugal. For the first time, the science fair was organized within a school, with the participation of students as the staff. The fair took also place in a different city, smaller and with a lesser number of schools in the region. In this communication we intend to show the evolution experienced in organizing this event over the last three years. Replies to questionnaires prepared for both students and teachers allowed us to assess our initiative and draw conclusion that will be presented herein. We will review how the work was carried out in different schools. We show how to organize a large scale science fair within a school environment and suggest methods to include these activities in a school daily context.*

Keywords. Hands-on, school organization, science fairs.

1. Introduction

The main role of the schools is training young peoples to become active positive individuals within societies. This requires a teaching approach based on varied and diverse strategies in order to enable the acquisition of the required knowledge and the development of skills at the procedural, conceptual and attitudinal level [1]. Despite the curriculum orientations, the lack of time, of resources, or even of experience of teachers and students, to the teachers is usually given the responsibility of regulating the strategies they should use at the classroom to address all the subjects, goals, methods and approaches to data collection, given little or no space to the students' effective intervention.

Some authors state that this fact could be responsible by given students a wrong idea about science [2]. If students didn't learn about science and how to do science, the real comprehension about the scientific and technological literacy is being compromised [3].

Here arises a great advantage of science fair projects, because students are encouraged to pursue their own goals and ideas [3]. Therefore, they have the opportunity to explore and solve problems related with their personal interest and also subjects about the world that surround them. Usually this allows a relation between science and different school subjects or with everyday life phenomena [4]. Therefore, students' participation is useful to science classes since they gain the habit of registering data and taking notes, as well as patience and resilience on the pursuit of their objectives [5]. They learn and statistical data and others forms or organize information, such as the use of graphs and tables to present their results, use adequate and varied literature to help their argumentation, and learn the practices of research in science, and a widened scientific vocabulary [3].

2. The 3rd Science Fair organization

During the school year of 2010-2011 the first edition of the science fair was organized [6]. The second edition was in May of 2011-2012 [7]. Taking into account the wide acceptance by teachers, participating students, and visitors, it was decided to continue with the initiative and organize the 3rd edition, in April of the current year.

The organization of the fair was made in the same way, with two differences: it was organized in a different city and the organization was in charge of a school, the Colégio do Minho, in Viana do Castelo. However, the fair was still aimed to students from the 5th to 12th grade (aged 10 to 18 years) from regular or professional education and was divided into 3 age categories: 5th and 6th grades, 7th to 9th grades and from 10th to 12th grades.

The main goal was for students to develop a scientific project in any field. Several factors were evaluated, such as scientific rigor, quality of presentation, originality, and interdisciplinarity.

The science fair announcement continues to be made at the beginning of the school year by e-

mail to schools and teachers and publicized at the science fair website. The news was publishing in journals and the school that organized also publicized along the city's schools.

After all the schools proceed to their registration, we plan the space for the exposition and lunch to all the teams. And at the Science Fair day, the older students from Colégio do Minho, were the staff. They were responsible for distributing the tables according to the plan prepared in advance based on the needs of each group. They guide the groups to their places, distributed the kit of participation and were always there to help with any need.

3. The evolution of the fair participation

The science fair has evolved positively, on the number of participants, visitors and in the quality and diversity of the projects presented.

On Table 1 it is possible to see how the number of responsible teachers from projects, the number of projects and the number of participants evolved.

Table 1. Participation on the two editions of the fair

	1 st edition	2 nd edition	3 ^r edition
N ^o of schools	8	9	8
N ^o responsible teachers	9	14	14
N ^o of projects	38	58	42
N ^o of participants	131	178	114

The first fact here pointed is that, despite the science fair be divided into three categories, only the 1st edition had related projects in the category of the youngest.

In addition, when we look to Table 1 despite the number of schools participation and teachers remains the same, is possible to verify the decrease of projects. This fact was essentially explain by the fact of the fair happens one month earlier when we compare with the two previous editions. Students haven't enough time to finish their projects. Two schools didn't bring any projects because of this fact and others bring only some of the projects because students weren't capable of finishing them on time. Another factor pointed out by teachers is the lack of resources and facilities available in schools due to the new measures implemented in Portuguese schools.

On the other side, is important to refer that all the schools participants and teachers involved are practically the same from previous editions or teachers that knew other teachers that already participated or visited previous editions and publicized this event. Actually, we have not much success on bringing new schools from Viana do Castelo to participate. In reality only one school that had never participated or visited the previous editions accepted the challenge.

But we accomplished one thing: others schools visited the fair and with that and all the publicity that was made on newspapers and even on television had a great feedback. And we expect that next year more schools from this city accept the challenge of participate.

4. Teacher's opinion

The analysis of the questionnaires over the three years allows us to verify that teachers have been providing more time to work with students, as you can see in Figure 1.

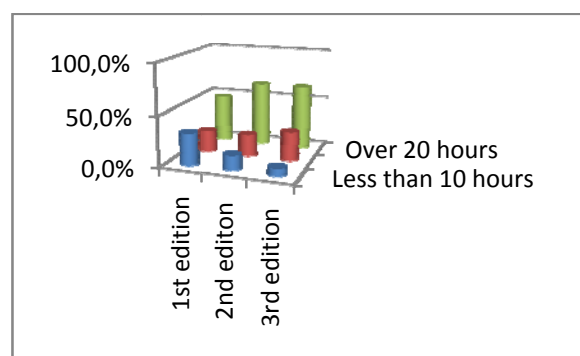

Figure 1. Time available from teachers to help students on the three editions of the science fair

On Figure 2, we can see how teachers managed their time to help students. In a general way, teachers involved their subjects on the development of the projects. Most interesting was the fact that on the first two editions teachers of physics and chemistry were the most active, followed by biology, but in less number. On this edition, have a stronger presence, either in the number of teachers who guided the project, and either in the number of projects themselves. Another pleasant surprise was the participation of teachers with students of vocational education, which until now has been virtually nonexistent.

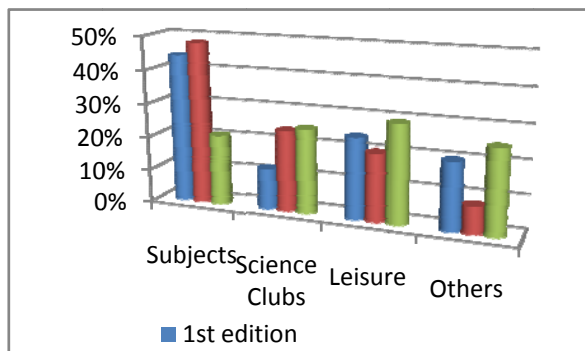

Figure 2. Places where teachers helped their students during the three editions (1st edition - left bar; 2nd edition - middle bar; 3rd edition - right bar)

Contrary to what has happened in previous years, despite the teachers are involved more hours on the development of the projects with their students, their implementation in the classroom seems to be decreasing. They seem to canalized their projects more to science clubs, leisure time or other situations like the named study rooms.

This also leads to the explanation of the fact that the decrease of projects by teacher, because, being developed outside of the classroom, there is no requirement to involve all students in this activity, but only those who really want to participate.

For the work done by the students, in general, in the three editions, teachers believed that the students worked with a lot of enthusiasm, commitment, imagination, rigor and autonomy and recognized that the students' participation in this project has brought some benefits to their subjects but that the participation in these science fairs, allowed the students developing skills beyond those that would be necessary only for their subject.

Thus, this is a type of activity that all teachers say they will continue to work. The majority seems to be convicted that is possible to implement science fair projects in classes, but they pointed the lack of time as a possible problem and the need of coordination with teachers from other fields and the school community in general can also be hard to do.

5. Student's opinion

When questioned about the reasons that led them to participate in this activity, the students, in the three editions, gave us several answers, being the

most predominant, the fact that they like science, as it is possible to see on Figure 3.

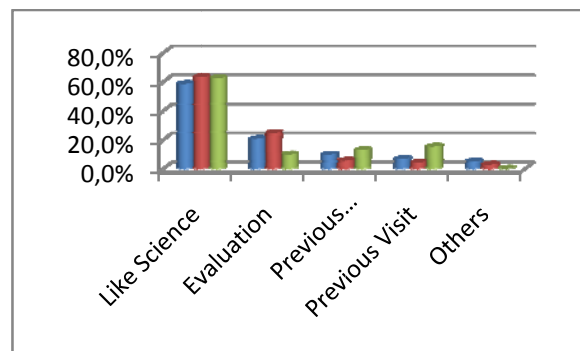

Figure 3. Reasons for student's participation at the science fair (1st edition - left bar; 2nd edition - middle bar; 3rd edition - right bar)

The fact of students participate at the science fair because it counts to their evaluation has always been point out, despite very few students pointed this reason as the only reason to participate. However, this year there is a reduction in this answer, which is directly linked to the fact that more projects are being developed outside the context of the classroom.

On the other hand, the fact that the students visit others science fairs, including previous editions of this or had participated previously, are two factors that led them to want to participate in this 3rd edition.

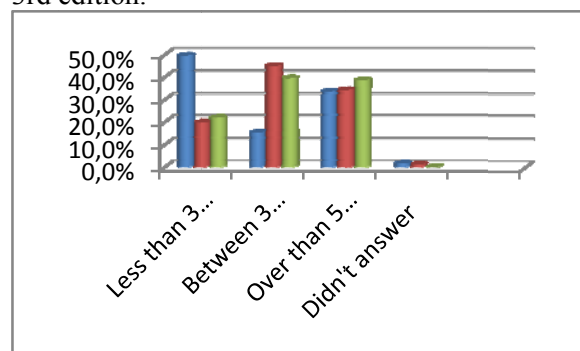

Figure 4. Time schedule for student's to develop their projects, during the three editions (1st edition - left bar; 2nd edition - middle bar; 3rd edition - right bar)

The fact that students and teachers are more familiar with what is expected from projects for a science fair, has led to an increase in the time available for their development, as is possible to see on Figure 4. Their greater dedication of time has led to projects of greater originality and quality. Many of the students are no longer looking for experiences to reproduce. They look

for innovation and lead a serious investigation including different tests of different hypothesis, and statistical studies of their work throughout the year.

When questioned about where students worked on the projects, we find something interesting and that apparently seems to contradict what the teachers said earlier about the time available in subjects for the development of projects, as is possible to see in Figure 5. For teachers, this trend seemed to be declining while the responses of students remain approximately equal over the three editions. However, this is easily explained. Teachers who answer to this inquiry are those who accompanied the students to the fair. But according to several students, there is a wide interdisciplinarity between teachers who assisted in the development of projects. It is found mainly among teachers of physics and chemistry and math, or between physics and chemistry and biology (in Portugal, Physics and Chemistry is only one subject and the teacher is only the same).

In addition, these students continue to show their interest in science by the time they seem to devote to these projects, both at home and at school, in their spare time.

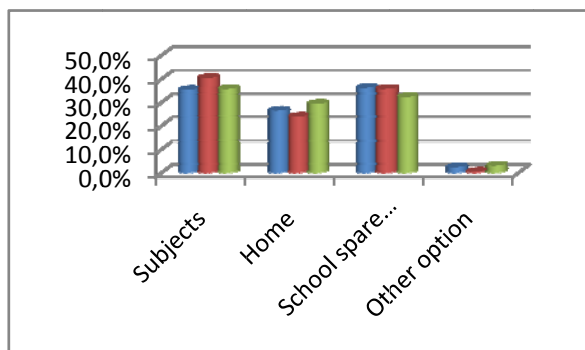

Figure 5. Places were students work on their project, in percentage (1st edition - left bar; 2nd edition - middle bar; 3rd edition - right bar)

Figure 5 reveals one more time what was said previously. Teachers of physics and chemistry seemed to be more involved, and their involvement increased significantly, followed by biology teachers. The great news become from math, that appears as a fundamental peace for some of the projects. And this came associated to the fact of students became more concerned with the statistical treatment of their work or prove through calculations some aspects of their works.

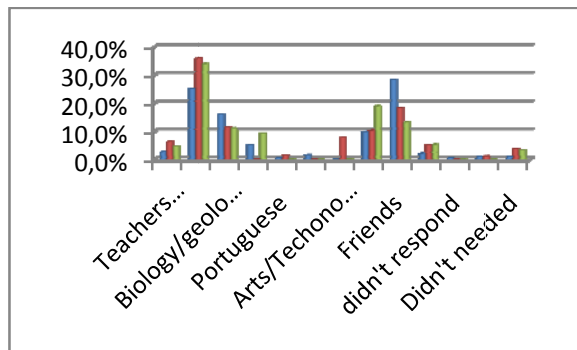

Figure 6. Aid provided to students throughout the three editions, in percentage ((left bar - 1st edition; middle bar - 2nd edition; right bar - 3rd edition)

Behind that, family and friends continue to seem a constant help on the development of their projects. And this aspect is very important because it means that not only the mentors of the project learn something new, but they are also capable of involve others on this journey.

Figure 6 allows us continue the analysis about the advantages for students to participate on science fairs. And in all of the editions the answers were similar. The most mentioned by students is that it helped them to understand some new concepts.

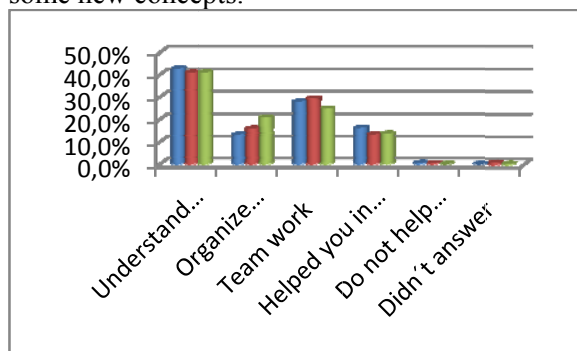

Figure 7. Benefits of participating in the science fair, in percentage (1st edition - left bar; 2nd edition - middle bar; 3rd edition - right bar)

The ability of develop, with success, team work is also an important aspects for their future, as well as the fact they developed laboratory skills that help them in classes as physics and chemistry (whose curriculum has a large laboratory component) and the organization of information that can be useful not only at school but also on their daily life because they gained method to organize their ideas.

6. The 4rd Science Fair Hands-on Science

Our research work on Science Fairs will be further continued. 4th edition will follow the same characteristics

We intend to see if there will be an higher compliance by schools, their teachers and students, of Viana do Castelo, who now already visited our Hands-on Science science fair and already understand our objectives and way of doing. We will follow with this study trying to observe the evolution of the science fair and of the opinions of teachers and students and to verify if the trends herein reported remains.

7. Conclusions

These three years of HSCI' science fairs in Portugal clearly enabled us to conclude that this is an activity welcomed by teachers and students. Several of them participate more than once at our science fairs or the fact that of all students and teachers said that would like to repeat the experience.

We can also conclude that this approach in the real sense of science fair projects allow the effective development of various valuable skills, competencies and knowledge, at a procedural conceptual and attitudinal level not only in what concerns science education but in the overall. That means that it is really possible to use this kind of projects to teach concepts or to help students to understand them.

Another important factor on the quality of the projects is the time available for their development but also the promotion of interdisciplinarity. Equally important is the social, familiar and scientific relationship that is possible to establish when family and friends are involved in the dynamic of the science fair projects to be developed by the students themselves.

In order for the process to achieve all its potential success it is important to make it an habit, both to teachers and students as well as the school, in order to be possible to develop these projects in the classroom for the entire class and not only with just some of the students. Resilience and dissemination of the success of this type of activities is fundamental.

Finally it was proven that it is interlay possible to a small school to organize a national science fair as our Hands-on Science one. The involvement of older students as part of the science fair "staff" was a very interest and motivating idea.

They gain a major sense of responsibility and all of them would like to repeat the experience.

8. Acknowledgements

This work was supported by FEDER through the COMPETE Program and by the Portuguese Foundation for Science and Technology (FCT) in the framework of the Strategic Project PEST-C/FIS/UI607/2011.

9. References

- [1] Martins T. (2001). Programa de Física e Química A. Portugal: Ministério da Educação.
- [2] Windschitl M. (2003). Inquiry projects in science teacher education: What can investigative experiences reveal about teacher thinking and eventual classroom practice? *Science Education*, 87(1), 112-143
- [3] Bencze JL, Bowen GM. (2009). A National Science Fair: Exhibiting support for the knowledge economy. *International Journal of Science Education*, 31(18), 2459-2483.
- [4] Scheneider RM, Lumpe A. (1996). The Nature of Student Science Projects in Comparison to Educational Goals. *Science*, 81-88.
- [5] Salisbury A. (1987). Mechanisms for popularizing science through formal and informal education. *International Journal of Mathematical Education in Science and Technology*, 18(4), 535-545.
- [6] Esteves Z, Costa MFM. "1st Hands-on Science Science Fair". Proceedings of the 8th International Conference on Hands-on Science, Ljubljana, Slovenia, 2011.
- [7] Esteves Z, Costa MFM. "2nd Portuguese Science Fair "Hands-on Science" Proceedings of the 9th International Conference on Hands-on Science, Antalya, Turkey, 2012.



A COUPLE OF PHYSICS TEACHING IDEAS

Ludmila Onderová¹, Jozef Ondera²

¹*P. J. Šafárik University in Košice, Faculty
of Science, Institute of Physics, Slovakia*

²*Dubnica Technological Institute,
Dubnica nad Váhom, Slovakia*

ludmila.onderova@upjs.sk, ondera@dti.sk

Abstract. *Experiments and experimental work have an essential role in physics education and can be used for demonstrations of physical phenomena and also as good motivators. The experiments could enhance discussion about interesting problems and those discussed in this paper could be presented in a form of problematic tasks, asking students 'Why' or 'Explain!' The simplicity of the tools involved in the experiments allows students to perform the experiments on their own and think about their physics origin. The presented ideas document also that a lot of interesting experiments are easy to do and teachers can use them.*

Keywords. Hands on experiments, Physics teaching

1. Introduction

“Physics is the future”, assure us physicists and physics teachers with conviction. “Physics is out of touch with real life and difficult” is a similarly determined statement of many students. As research results show, students who take physics courses during their study and learn about many different physical phenomena have a lot of difficulties in understanding the physical world. Their learning of facts about science remains inside classrooms and has little effect on their thinking about the larger physical world [1]. Lots of concepts to be learned are too complicated, all in all, there is not enough time to learn to think in terms of physics and to practice what has been learned, there are not enough practical exercises, etc. As a result of these conditions, many students primarily learn physical formulae and technical terms without being able to find their connection with reality. In many cases physics as a school subject has lost much of its inherent proximity to nature and environment. To many pupils and students physics seems like a dead and difficult foreign language, so remote and

unreal that they cannot realize what it is all about. That's why there is a great effort to use methods and ways of teaching that could help in deeper understanding of physical phenomena [2]. One way of contributing to a higher attraction of the subject of physics may be to suggest interesting physical problems from real life in funny pictorial form [3]. Another possible method how to make teaching more interesting is a physical experiment. Most students like experiments. There are many ways how to perform physical experiments in physics teaching one of them being simple hands-on experiments.

2. Hands on experiments

There are plenty of reasons why we should do simple hands on physical experiments; the most important are following:

- ***Experiments play an important role in motivation of students*** – hands-on experiments help to discover physics in the real world, the world the students live in. It is obviously useful and interesting. Simple hands-on experiments with their process and results are many times surprising for students and motivate them to find out the causes of the contradiction or strange behaviour.
- ***They can be performed with simple tools*** – most of simple hands-on experiments are able to explain and demonstrate physics concepts using items that can be usually found in a household.
- ***They are not expensive*** – economic difficulties of most schools led us to believe that simple cost-saving experiments or measurements are the best solution for them.
- ***They can be done by students themselves*** – students don't need any special equipment, not even a laboratory, they can explain an application or a fundamental principle of physics using everyday items and do these experiments at home.
- ***They enable active learning*** – simple hands-on experiments provide students with an opportunity to form their own questions, create hypotheses, their own theories to explain results of the experiments they have done. They get a chance to explain physical phenomena in the world around them.

3. Examples of the hands-on experiments

Several simple experiments can utilize the plastic packages that serve as wrapping shells for toys sold in “Kinder Surprise” eggs. In the following paragraphs we will refer to these packages simply as kinder eggs.

3.1. Mysterious egg

A thin thread or silicon wire is thread through a kinder egg (a small plastic egg consisting of two parts) with a steel ball mounted on one end and a wooden ball placed on the other one. Hang the system in a vertical position keeping the steel ball in a hand. We can observe that the egg slides down the thread into the proximity of the wooden ball.



Figure 1. *Mysterious egg*

Repeat the experiment changing the position of the balls, so that the steel ball is on the upper side of the thread and we are keeping the sling holding the wooden ball in a hand. We perceive in this case that the egg is not moving down but stays in a stable position on the wire. (Fig.1) What is trapped inside the egg?

There is a thin plastic tube with the thread passing through. If the light wooden ball is at the bottom, the thread is not stretched and there is no friction between the thread and the tube; thus the egg can move easily. If we turn the whole system and the steel ball is at the bottom end, in this case the thread is stretched and pulled to the tube

which significantly increases the friction until the moment at which the egg is not moving any more. It is necessary to remark that a similar effect could be obtained in different ways and it is not a bad idea to ask the students to discover them and create the same system in which the described egg's behaviour is realized differently.

3.2. Against the tide

Take a long transparent pipe closed on one end, whose diameter is not much larger than the diameter of a kinder egg. Let the egg fall inside, to the bottom of the pipe. When water is added inside the tube, the egg goes up. Fill the whole tube with water, close it and turn it afterwards. Holding the tube in an upside-down position, we observe that the water is flowing away whereas the egg is not moving in the same way but floats against the flow. How can we explain the egg's behaviour? (Fig.2)



Figure 2. *Against the tide*

To explain it, we have to consider that there is buoyant force acting both in the air and in the water which comes into play when the tube is turned. The lower edge of the egg is positioned in the air so the pressure at this point is equal to the normal atmospheric pressure. The pressure at the upper edge is decreased by the pressure ρhg , where h is the height of the water column around the egg and ρ is the density of the liquid. If we consider the egg to be a cylinder with S being the base area and H the height, the resulting condition for the egg floating up is written as

$\rho_k gHS \leq \rho ghS$, where ρ_k is the average density of the egg. Assuming the H is equal to h , the side walls of the egg are fully immersed in the liquid; as long as the ρ_k is smaller than ρ , which is fulfilled in our case. As a consequence, the egg flows up in the liquid.

3.3. The egg turning upside-down

A two-coloured kinder egg is perforated on both its sides and hung on an iron wire which is threaded in the middle. Keeping the wire in the hand, we examine carefully which side of the egg is upward in the air. After deflecting the egg from the balanced position, it stabilizes in the same position as before. Immersing the egg in a liquid afterwards, the water penetrates inside which leads to turning the egg upside down - the side of the other colour is up now. After picking the egg out from the liquid, the water starts to flow away and egg returns to its equilibrium position finally. What causes such behaviour of the kinder egg? (Fig.3)

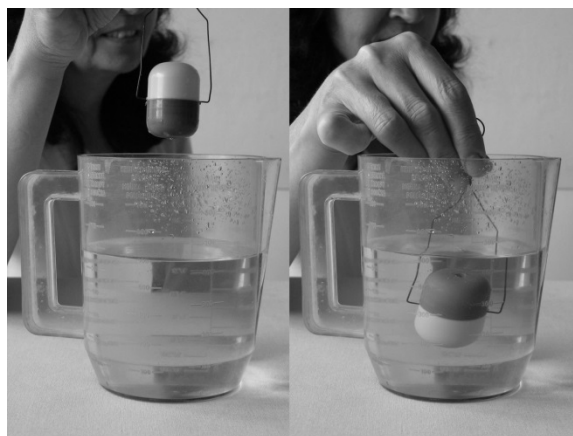

Figure 3. The egg turning upside-down

The egg is in the equilibrium position in the air so its centre of gravity is placed under the axis of rotation, passing through the pivot. Thus when deflecting the egg from its equilibrium position the momentum of the gravitational force with respect to the rotational axis causes it to return to the original position. If we want to move the egg's centre of gravity it is necessary to hang some object in the upper part of the egg. Immersing the egg in a liquid, it starts to be filled with water (the escaping bubbles of air prove that) which causes the equilibrium position to become unbalanced and the egg turns on its side. Putting the egg into the water, the buoyant force starts to act at the centre of gravity of the immersed part. Thus to turn the egg, the point of

application of the buoyant force has to be under the axis of rotation and additionally, the momentum of rotation arising from this force has to be higher than the momentum of rotation caused by the gravitational force. Because of that we have to hang some object into the lower part of the egg whose average density is smaller than the density of water, such as a piece of polystyrene. If this piece is moving in the liquid, it prevents the egg from turning around. [4]

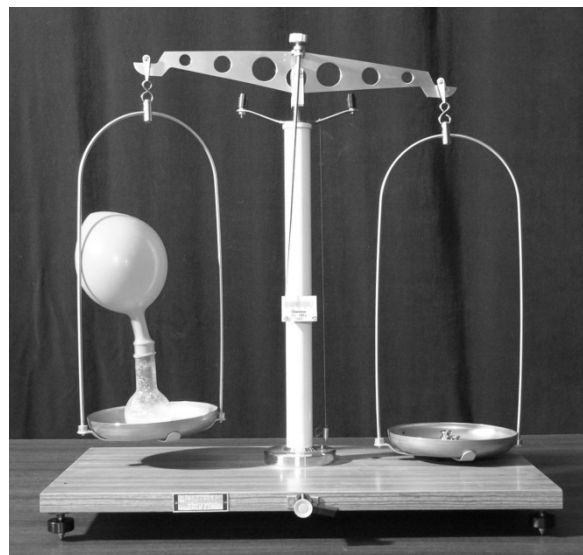

Figure 4. Does carbon dioxide weigh less than air?

3.4. Does carbon dioxide weigh less than air?

First we inflate a balloon several times to make it expand. Then we pour a small amount of vinegar into a flask. We put some baking soda (sodium bicarbonate) into the balloon, pull the balloon neck over the flask neck and fix it firmly using a thread or a rubber band. We make sure to prevent any of the baking soda from falling into the flask. Then we place the flask on the scales, balance them and lock them. Now we let the baking soda fall into the vinegar and shake the flask to make the vinegar and soda mix. We wait until the turbulent effervescence is over and then we unlock the scales. The balance has broken, the pan with the flask and the inflated balloon lifts up as if the balloon was filled with a gas lighter than air. The force acting on the pan is now lower than before. As a result of the chemical reaction that takes place after mixing the vinegar with soda, carbon dioxide is produced causing inflation of the balloon. Since the volume of the balloon has increased, the aerostatic buoyant

force acting on the balloon has increased, too. However, the total weight of the flask with the balloon has not changed. The buoyant force is oriented vertically upwards, therefore the resulting force acting on the pan with the flask and the inflated balloon vertically downwards is lower than before. (Fig.4).

3.5. How to create a rainbow?

To carry out the experiment we will need: 4 transparent glasses, water, food colours – yellow, green, red and blue, a transparent straw and salt. We put the four glasses filled with water of different colours – blue, red, yellow and green (colours for painting eggs can also be used for the purpose) on a table. Then we submerge the transparent straw into the glasses one by one. First we submerge the straw circa 2 cm into the glass with blue-coloured water. We close the top opening of the straw with a finger, take it out of the glass with blue water and move it on to the red water one. Once again we submerge the straw circa 2 cm deep into the glass, then we release the finger, submerge the straw 2 cm deeper and close it with the finger again. We ask the pupils: What colour the water in the straw will be after it is taken out of the glass? Since the pupils are familiar with colour mixing they expect the resulting colour to be purple. To their surprise, after the straw is taken out of the glass, they can see a column of blue colour on top of a red colour one, which means that the colours don't mix. If we continue with the experiment in the described way, i.e. if we gradually submerge the straw into the yellow and the green colour, we will end up with a four-colour rainbow – the columns of coloured water won't mix. (Fig.5)

The pupils have to solve a problem task: how to explain that the liquids didn't mix? During a problem-solving discussion we can let them perform another experiment, in which they will – following the procedure described above – first submerge the straw into oil and afterwards into water. This experiment shall guide them to a solution that the coloured water in the glasses must have different density. Then we will ask them the next question: How could we easily carry it out?

As an aid we can use yet another experiment, namely the one that shows that the same egg can behave differently in two seemingly same liquids. In one of the liquids the egg sinks, in the other it floats. Most pupils are usually familiar with this experiment and they know that the

different behaviour is caused by salt added to the water. This way we can together with the pupils come to an explanation of the original experiment that coloured water in the glasses has different density, which can be achieved by adding salt. The least amount of salt, one spoon, is added to the glass with blue-coloured water and to each of the remaining glasses we add one spoon more, i.e. to the glass with green-coloured water we add four spoons of salt. The experiment is suitable for verification of a correct understanding of the density of liquids. At its end we can ask one more question: What will happen if we turn the straw upside down? The pupils should be able to respond correctly that the colours will mix and the water will be dark-brownish or blackish. [5]



Figure 5. How to create a rainbow

3.6. Dangerous bottle

We present to pupils a casually looking closed bottle filled with water that is covered with caution signs like: “Do not open!”, “Dangerous!”, etc. We ask a courageous volunteer to open it. To everybody's surprise, after the cap of the bottle is removed, the bottle starts squirting. From the result of the experiment it is evident that there are holes in the bottom part of the bottle. The task for pupils is to explain why the water doesn't squirt nor even leak out while the bottle is closed. In order to help them find the correct explanation we can perform

another experiment. We show to the pupils a vessel (e.g. a coffee can) with several holes in its bottom. Then we fill the vessel with water by submerging it into a bigger one (e.g. an aquarium). It is natural that when we lift the vessel filled with water out of the aquarium, the water starts flowing out. Then we fill the vessel with water again and close it hermetically with a lid that we hold firmly at the vessel by a thumb. When we lift the vessel now, no water leaks out.

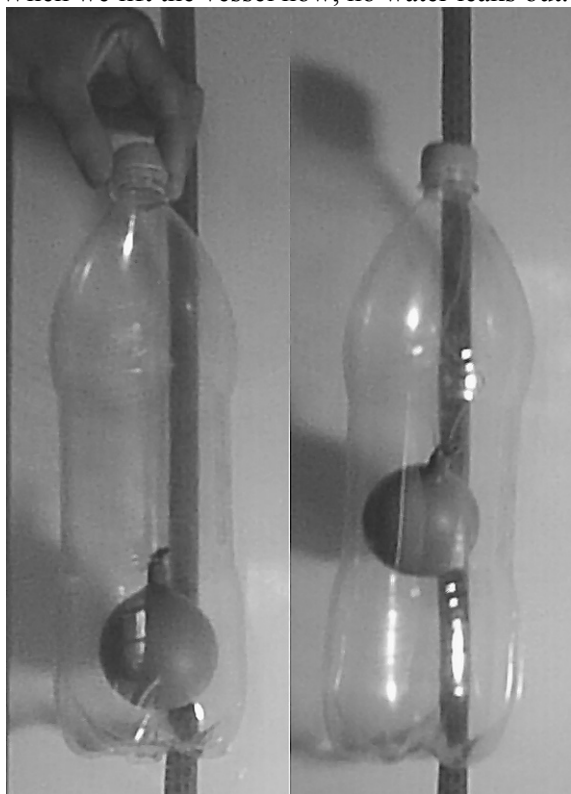

Figure 6. *Weightless condition in a plastic bottle*

When we put the finger away from the lid, water starts flowing out. When we put the finger to the lid again, the water stops leaking shortly afterwards. If the pupils don't find an explanation, we let them examine the vessel's lid. They will find out that in the middle of the lid there is a small hole made by a needle that we cover and uncover during the experiment by the thumb. After this finding the pupils are usually able to correctly explain the experiment, i.e. that the behaviour of the can is caused by the atmospheric pressure of the air. When the hole in the lid is covered, the atmospheric pressure acts on the holes in the bottom of the vessel and prevents the water from flowing out. When we uncover the hole in the lid, air gets into the vessel and the pressure acting on the liquid from both the top and the bottom side is approximately the same – it is the atmospheric pressure. When

we cover the hole in the lid with a finger, the atmospheric pressure acts only on the bottom side of the vessel and as the water flows out of the vessel the pressure of the air inside decreases – underpressure is created. When the difference between the atmospheric air pressure and the pressure of the air inside the vessel reaches the value of the hydrostatic pressure of the liquid in the vessel, the liquid stops flowing out of the vessel.

In the same way we can explain the behaviour of the “dangerous bottle”. While the bottle is closed, the pressure inside and outside is different. The outside pressure is higher than the pressure of the air inside the bottle. The difference between the atmospheric pressure and the pressure inside the bottle prevents the water from flowing out. However, once we open the bottle, the pressure inside and outside the bottle becomes equal and the water starts flowing out of the bottle as a result of the hydrostatic pressure of water. [5].

3.7. Weightless condition in a plastic bottle

The term “weightless condition” is mentioned within basic-school physics e.g. in the subject matter about astronomy. Pupils sometimes ask why objects in satellites “float” freely. Can we put bodies to a weightless condition in a laboratory? [6] The solution proposed by us is easy to perform and sufficiently explanatory, too. We put a small balloon, a so-called water bomb, partially filled with water inside a bigger plastic bottle. We inflate the balloon in the bottle slightly and then we tie it to a rubber thread. It is useful to test the length of the thread in advance so that it is stretched by the weight of the balloon neither too tightly nor too loosely. We fix the other end of the thread to the neck of the bottle and close it with a cover. We let the bottle prepared in this way fall from a certain height by a free fall to a soft pad. Pupils observe the movement of the balloon inside the bottle during the fall and together with them we can come to its explanation. After the system is released it moves by a free fall and therefore is in a weightless condition. The balloon is subject only to elasticity forces, the rubber band ceases to be stretched and the balloon moves to the middle of the bottle. (Fig.6) Nowadays there is no problem for pupils to extend the observation by recording a video, e.g. using a mobile phone.

4. Conclusion

The presented ideas document that a lot of interesting experiments are easy to do and we believe that teachers will use them not only for diversification of their class-works, but also as an inspiration for improvement of their own experiments.

5. Acknowledgements

This work was supported by the Slovak Research and Development Agency under the contract No. LPP-0223-09.

6. References

- [1] Thornton RK. Using the results of research in science education to improve science learning. In: Nicosia, Cyprus: Keynote address to the International Conference on Science Education. 1999.
- [2] Lyons T. Different countries, same science classes: Students' experiences of school science in their own words. 2006 International Journal of Science Education, 28(6), 591-613.
- [3] Chovancová M. Some Motivation Experiments in Physics Study. In: Kováč J., Reiffers, M, editors. Proceedings of the 15th Conference of Slovak and Czech Physicists; 2005 September 5-8; Košice, Slovakia. Košice: Slovak Physical Society; 2006. p. 115-117.
- [4] Fishman A, Skvortzov A, Jacob, I. A multimedia videobook of physical problems. In: Dobis P., Koktavý P., editors. Proceedings of 4th International Conference on Physics Teaching in Engineering Education PTEE 2005. Brno 2005 W 4.
- [5] Onderová L. Niekoľko nápadov pre vyučovanie fyziky III. In: Drozd, Z., editor Proceedings of Physics Teachers' Inventions Fair 15 2010 September. 3-5; Praha, Czech republic: Prometheus 2011, p.168 – 172.
- [6] Sliško J, Planišič G. Hands-on experiences with buoyant-less water. The Physics Education, 2010; Vol. 45, May; 290 – 97.



“KATTAN SCIENCE SNACKS”: SMALL EDUCATIONAL SCIENCE EXPERIMENTS TO POPULARIZE SCIENCE AMONG THE PALESTINIAN SOCIETY

Bisan KM Battrawi

bisan@science.qattanfoundation.org

Abstract. *This presentation discusses the role of informal science in raising interest in science where an informal science learning activity called ‘Kattan Science Snacks’ is highlighted. The ‘Kattan Science Snacks’ are organized by the Walid and Helen Kattan Science Education Project (of the Qattan Center for Educational Research and Development) – Ramallah, Palestine, as part of the informal science program of the project. The activity was inspired by the Exploratorium® and the educational resources the Exploratorium has published in the Exploratorium Science Snackbook© 2009. The ‘Kattan Science Snacks’ activities are events in which people from the Palestinian society are invited to interact and experiment small and simple science experiments, in an attempt to raise the society's interest in and familiarity with science. The ‘Kattan Science Snacks’ are targeted at the Palestinian families; and are simple, easy-to-do-at home, fun and informational experiments. Moreover, the activity itself is organized by students who are invited to the Walid and Helen Kattan Science Education Project’s center two to three weeks ahead to work with the researchers at the center on the experiments, develop conceptual knowledge, create informational brochures, and engage in science. On the day of the activity, the students are available for the audience as “assistants” to assist them when needed. The ‘Kattan Science Snacks’ have witnessed tremendous attention from the society as they provide both a learning venue about science, and a fun experience for the family. Additionally, the participant students have expressed the importance of such an activity for them especially that they are engaged in it from the first day of organization to the day of the event. A group of students has been inspired by the ‘Kattan Science Snacks’ experience and decided to carry on another ‘Kattan Science Snacks’ activity with their own society in a rural part of Palestine.*

The activity presents an example of the strength of informal learning activities and their importance in raising interest in science. Hands on and informal science are important settings to raise interest in science; allowing one to experience science in an interactive unique way without the stress of being graded. Observations and interviews with the participant students show evidence of leadership among the students and a sense of responsibility for communicating science to the society. Moreover, observation and interviews with the participant families demonstrate the effectiveness of such activities in popularizing science in the societies. The assessment of the activity will provide the essential procedures for the initiation of student-led science community forums in the rural Palestinian areas.



BRINGING BACK OLD PHYSICS & CHEMISTRY INSTRUMENTS TO LIFE: FROM SECONDARY SCHOOLS TO THE GENERAL PUBLIC

João Oliveira, Isabel Malaquias
jabpo@ua.pt

Abstract. *The secondary school evolved to a recognizably European institution as the nineteenth century progressed, presenting as common characteristics to be public, secular and run by the state or by local authorities. At the same time a lot of what was inherited from early humanistic colleges was still visible, reflecting the classical culture. Around 1840s, several countries tried the development of modern alternatives to classical education, introducing the scientific studies.*

By 1836, Portugal was facing conditions to institutionalize the secondary school system, the so called “Ensino liceal” (Lyceum), fixing a set of disciplines, the distribution of secondary schools throughout the country, their organization, etc. A novelty was the creation of new disciplines as “Physics, Chemistry, and Mechanics applied to arts and crafts” (the 7th discipline), and the 8th, “Natural History for the three Nature kingdoms applied to arts and crafts”.

The first Lyceu was created in Lisbon in 1839, by 1844 three were already functioning and by 1848 eleven others were created in the country, including the islands (Azores and Madeira). The implementation was not smooth all along the century as several times the gap between the legislator and the concrete capability of attaining a functional modern institution was present. However, the seeds were sprouting, namely with the creation of laboratories and instruments acquisition.

During a project (POCI/CED/60998/2004) started in 2004 called “Old scientific instruments in the teaching and popularization of Physics” that lasted three years, we could find some remaining of those old instruments scattered throughout the schools, that testifies the early teaching/learning of Physics and Chemistry.

Some outcomes of this project were connected with their popularizing in the society, in particular:

1 – A public exhibit of some of the most prominent instruments that lasted a month.

2 – An internet site (<http://baudafisica.web.ua.pt>) where there is a repository of these instruments that can be searched by scientific area, school or instrument. For each one there is an image and description.

3 – A database that feeds the site as the information is inserted there.

In the present communication we will follow three guiding directions to present some instruments used to learn how we can deal with a bicycle air pump and how can we relate it with water pumps, fire pumps or even Hero’s fountain; how can we locate ourselves in the universe and attend the observation of eclipses, with some orreries; or even to discuss the chemical elements that can exist in the sun or stars, or simply in a candle’s flame.

The beauty of many of these devices, and their rediscovery in the context of didactic and heritage potentialities makes possible the general public interest about concepts and practical applications not only of Physics but also of Chemistry with a renovated look at old didactic instruments that frequently present themselves as practically open boxes to our curiosity.



FIGHTING SCIENTIFIC ILLITERACY IN PORTUGAL FROM MID XVIII CENTURY TO MID XX CENTURY: A FEW MEANINGFUL ATTEMPTS TO SPREAD SCIENTIFIC KNOWLEDGE OUTSIDE THE PUBLIC SCHOOL

Maria Teresa S.R. Gomes,
João A.B.P. Oliveira
mtgomes@ua.pt

Abstract. *The Portuguese present day primary and secondary school system dates back to the XII century, and started at the monastery monasteries of Coimbra and XIII century at the monastery of Alcobaça. Since then, it has been under the wing of the church, until 1836, when the public secondary educational system, the so called “Ensino liceal” (Lyceum) was created. Although these were public schools, the number of students was very low: remaining around 3000 since 1836 till the twentieth century. Among the main disciplines taught, the 7th (Physics, Chemistry, and Mechanics applied to arts and crafts) and the 8th (Natural History for the three Nature kingdoms applied to arts and crafts), showed a genuine interest to teach applied science. However even after sixty four years of public school, in 1910, there were only 24 schools and about 8500 students for a total population of 6000000, and the illiteracy rate for basic reading and writing was 75.1 %, with a much higher scientific illiteracy rate.*

Although few, there are some examples of conveying the scientific knowledge to the general public. We just want to recall three striking ones. The first is the so called “Philosophical Recreation, or a Dialog about Natural Philosophy for the instruction of Curious People who did not have the chance to attend school” written by a Priest (Teodoro de Almeida) in ten volumes published between 1751 and 1800. The second one is a collection of 237 books, the so called “Library for People and Schools” published between 1881 and 1913, in Portugal and Brazil simultaneously, every fortnight. Each volume had 64 pages, and the subjects ranged from chemistry to fencing. The last one is a collection of 106 books, the “Cosmos library”, published between 1941 and 1948. It was divided

into seven sections with very diverse subjects from “Sciences and Techniques” (first Section) to “Present Day Problems” (seventh Section).



THE PUBLIC COMMUNICATION OF SCIENCE IN GRADUATE PROGRAMS IN PUBLIC HEALTH IN BRAZIL: A PERSPECTIVE OF COORDINATORS

Carlos Antonio Teixeira,
Paulo Rogério Gallo
carlostm.br@gmail.com

Abstract. *Introduction - The public communication of science integrates the concept of scientific culture and is related to the context of modern knowledge societies. These societies recommend that public policies for science and technology include the wider society in the processes of decisions, hence the importance of sharing scientific knowledge generated in the university graduate programs, with the population. Objectives - To describe and characterize conceptions that coordinators of graduate programs in public health in Brazil have about public communication of science. Methods - This is the report of an exploratory research that has analytical and descriptive characters. The approach is mostly qualitative, with quantitative measurements. The study was approved by the Research Ethics Committee of the Faculty of Public Health of Universidade de São Paulo and obtained Informed Consent from the participants. The categories were transformed into variables that allowed the data processing by the software Classification Hiérarchique Classificatoire et Cohésitive (CHIC®). Results - The conception of public communication of science by coordinators of graduate programs in public health in Brazil is not unanimous. Some coordinators understand it as scientific diffusion featuring a communication directed both to the scientific community and to society in general however without language distinction. Most of them understand public communication as scientific dissemination that characterizes the communication directed to*

pairs in the scientific field. Few of the coordinators conceive it as communication directed to society in general, which must be operated with an appropriate language code, which represents both a commitment and a challenge for the teacher-researcher. Conclusion - The notion of public communication of science as a social right is not explicitly present in the narrative of the coordinators of graduate programs in public health in Brazil, although in general the coordinators conceive it as a relevant activity.



INQUIRY ACTIVITIES IN STEEL PARK

Mária Nováková, Marián Kireš
marian.kires@upjs.sk

Abstract. With the intention to popularize natural and technical sciences among the young, a project – Steelpark – Creative Factory, was created. There, the visitors can explore and learn easily about various physical phenomena and their properties, or observe the reactions of various materials. The originator of the idea of the project is a steel company – U.S.Steel, which is also a guarantor of this exposition. The preparation of interactive exhibits lies on the cooperation of the Technical University of Košice, Pavol Jozef Šafárik University in Košice, Slovak Academy of Sciences in Košice and on a team of other diligent people. The Pavol Jozef Šafárik University in Košice is in charge of 10 exhibits which deal with magnetism. There is a stand, within the Science fair, which will be a part of the Steelpark exhibition. As an example, the exhibit of falling magnets can be mentioned. It demonstrates the interaction of a magnetic field and a metallic material on the principle of electromagnetic induction. Magnetic springs support creative thinking and searching for new uses of a classical principle of a spring, e.g. in transcribers and shock absorbers in cars. A magnetic field is made visible in a jar with glycerine and iron dust. Magnets will be put into tubes and iron dust will adapt into the shape of magnetic lines of force. As a result, visitors of a black magnetic room will be able to determine the position of the magnets hidden under magnetic needles. Gauss gun – a magnetic

accelerator is another exhibit which is attractive thanks to its resulting effect – catapulting of a small ball.



ENGAGING PARENTS INVOLVED IN THEIR CHILDREN'S LEARNING THROUGH HANDS-ON SCIENCE ACTIVITIES

Yi-Ting Cheng, Huey-Por Chang,
Wen-Yu Chang
tonia0213@gmail.com

Abstract. The last two decades have seen growing importance placed on research in parental participation in their children's science learning. Family does play a very important part in children's learning. Science education ought to begin at home, reinforcing parents' science knowledge as well as helping the children to learn. However, to date, there has been relatively little work conducted on this topic in Taiwan. To emphasize this point, the purpose of this study was to evaluate the influence in the Parental Involvement project by developing or revising hands-on science activities for family and having parents and kids work together at home with hands-on, inquiry science activities.

The project began in September 2011, when a parental science learning group was set up in a Taiwan elementary school. 12 volunteer parents of first, second and third graders took part in this study. A two-phase study was designed to achieve these objectives. Phase I, the study was set up a parental science group. A group meeting of 2 hours' duration was arranged biweekly. The participants were asked to read and discuss different kinds of science books (such as popular science books for kids or hands-on science activity books). They were also asked to do hands-on activities and revised the activity for their kids. Following meeting, 2-3 participants were selected to interview for approximately half an hour about their views about science, science learning, and hands-on science activities. Phase II, after each group meeting, participants were asked to do hands-on science activities with their kids at home and give suggestion to revise the activities. The data collection sessions were conducted individually and were video

recorded for later coding and analysis. Field-notes, questionnaires, worksheets, and artifacts were also collected to supplement the findings of study. Data analysis for each family science activity consisted of utilizing and categorizing the data collected during 30 videotaping averaging 1 hour each.

During the three semesters (one and half years) in participation, participants had had 30 meetings and completed 30 parent-child hands-on science activities at home. 15 hands-on science activities for family were developed or revised by parents. The results revealed parents appreciated the importance of hands-on learning in science and understood the importance of family involvement in children's science learning. Most parents were willing to learn from hands-on science activities with their children at home, they also would revise the activities for their children's need. Moreover, through parents' participation, they would find that they are capable of assisting their children in learning science. Parents would enhance their confidence and their attitude and knowledge of science at the same time. In summary, this study enhanced parents' understanding of scientific learning, increased science interaction between parents and children, and created a more active learning and inquiry science environment in the family. The article concludes with implications for theory, research, and practice.



BIOCIENTISTAS DE PALMO E MEIO - HANDS-ON SCIENCE FOR PRE-SCHOOLERS AT THE DEPARTMENT OF BIOLOGY OF UNIVERSITY OF MINHO

**Cristina Almeida Aguiar,
Maria Judite Almeida,
Maria Teresa Almeida, Andreia Gomes,
Sandra Paiva**
d1667@bio.uminho.pt

Abstract. In May 2008, in response to a specific request from a pre-school teaching institution, the Department of Biology of University of Minho opened its doors to children aged 4-5 years old, curious to meet scientists, their work and the laboratories (Mendes & Aguiar, 2011). Such interest and request were in line with the institution pedagogic project, aimed to know and to explore different professions and professional contexts. In this particular case, children wished to visit a research laboratory

and meet scientists and researchers. To welcome the children, the Department of Biology organized a MiniLaboratory where they could observe, experiment and participate in small scientific demonstrations within the scope of Microbiology, Botany, Animal Physiology and Genetics.

The initiative was so successful that it has become part of the Department of Biology regular offer in terms of experimental activities to the community, specifically for pre-schoolers, as it was considered a great way to "seed" the spirit and scientific curiosity in children. The program, named BioCientistas de Palmo e Meio, was recognized and cherished by the "Ciência Viva" National Agency. It now runs every year for three consecutive mornings, during which a total of nine classes of children are hosted. In the aftermath of the visit, children and their educators are challenged to produce individual and group records of their experience, creating drawings and/or other plastic art. The works are ultimately exposed to the general public in a public Library, for 2 to 4 weeks in June, after which the best individual and collective works of each age group are awarded a prize in a public ceremony. Currently this initiative is part of "Festa da Ciência", an event of the university School of Sciences that opens its doors to the civil society usually a week in May.

This communication aims to present the BioCientistas de Palmo e Meio project and its success among children, educators and parents, as well as to stress its importance in promoting scientific curiosity and knowledge. Science education is a major challenge in the context of promoting scientific literacy of citizens: it must contribute to the promotion of an informed, critical and committed citizenship. And this education should start as early as possible, to children in preschool, awakening them to critical observation of the surrounded environment and the scientific thought. According to Fiolhais (2011), the most effective way to wake up children and young to science seems to be through experimental activities, which in turn should be provided as soon as possible. A child who blooms to science does not necessarily have to be a scientist, but will certainly grow and become a more informed and aware citizen in the world.



Pre-service and in-service science teacher training

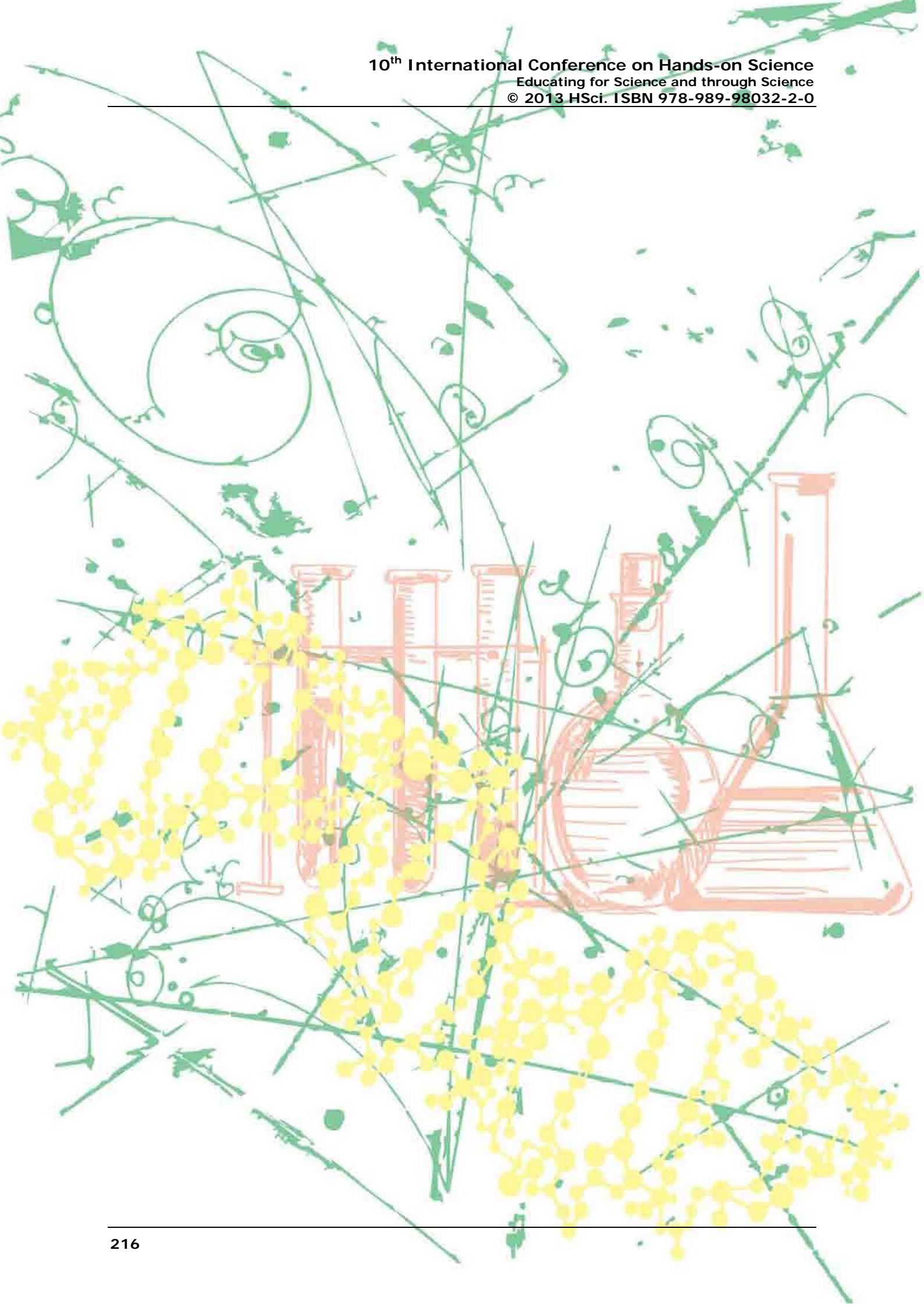

SCIENCE TEACHER TRAINING AT THE DEPARTMENT OF PHYSICS EDUCATION, MFF UK IN PRAGUE

**Dana Mandíková, Jitka Houfková,
Zdeněk Drozd**

*Charles University in Prague, Faculty of
Mathematics and Physics, Department of
Physics Education, Czech Republic*
dana.mandikova@mff.cuni.cz,
jitka.houfkova@mff.cuni.cz,
zdenek.drozd@mff.cuni.cz

Abstract. *The Department of Physics Education, Faculty of Mathematics and Physics, Charles University in Prague, offers a lot of activities designed to promote physics education to pre-service and in-service teachers as well as to students of different types of schools. The contribution gives information about selected activities that cover wide spectra of topics that can be presented to pupils and students from pre-school to university levels.*

The authors will introduce courses for pre-school children and teachers, for future primary and future secondary school teachers, demonstration sets of experiments for secondary school students and their teachers. The activities mentioned are developed and tested at the Department of Physics Education using immediate and long term feedback reflecting the needs of teachers and students.

The practical examples of one of these activities – courses for pre-service primary school teachers – will be presented in workshop “Experiments in Science at Primary School”.

Keywords. In-service Courses, Physics Education, Physics Experiments, Pre-service Courses

1. Introduction

The Department of Physics Education, Faculty of Mathematics and Physics, Charles University in Prague, offers a lot of activities designed to promote physics education to pre-service and in-service teachers as well as to students of different types of schools.

An introduction of four activities that we consider to be most important is given in this contribution. Several examples of *Seminars for*

in-service teachers training will be mentioned, the activities for pre-service teachers *Experiments in Science at Primary School* were chosen, as an example of activities for high school students *Experiments for High School Students* and *Physics Interactive Laboratory* are described and at last *Courses for pre-schools* are introduced.

The activities mentioned are developed and tested at the Department of Physics Education using immediate and long term feedback reflecting the needs of teachers and students.

2. Seminars for in-service teachers training

The *Seminars for in-service teachers training* organised by Department of Physics Education, are aimed on low cost and hands-on experiments and sharing of teaching ideas and creating of teachers' networks.



Figure 1. *In-service teachers build electronic kit*

Teachers like to take part in these seminars because they are constantly searching for ideas for new experiments doable in schools that are not sufficiently equipped and they like to share their ideas.

Some seminars bring suggestions to untraditional laboratory work or to experiments that can be done as homework or projects.

The seminars are supported by Ministry of Education, Czech Republic and the participants get certificates of attendance.

3. Experiments in Science at Primary School

Experiments in Science at Primary School is a seminar designed for future primary school

teachers, students of Pedagogical Faculty, Charles University, Prague. The seminar takes 135 minutes every week during two semesters. It is an example of cooperation between two faculties – staff of Faculty of Mathematics and Physics teaches students from Pedagogical faculty.



Figure 2. *In-service teachers course: Physics in kitchen*



Figure 3. *In-service teachers course: Electromagnetic induction in practice*

Primary school teachers are the first ones in the school attendance who introduce pupils to the natural science. Thus it is very important to gain their interest and to motivate them to future studies. Young pupils love to perform experiments and they want to know how things around them work. Our seminar provides the opportunity to familiarize the future teachers with experiments from the parts of natural science that are taught at primary school and gives them an opportunity to try them

themselves. The emphasis is put on hands-on activities of the future teachers and on self-production of simple teaching aids, as well as on correct explanations of shown phenomena and on ways how to present them to young pupils. What we consider very important is that the most common misconceptions are mentioned and discussed, too.



Figure 4. *Pre-service teachers making periscopes*



Figure 5. *Pre-service teachers launch air rockets*

4. Experiments for High School Students and Physics Interactive Laboratory

The high school teachers with their students from Prague and other cities are coming to Faculty of Mathematics and Physics to see sets of interactive experiments from various physics

topics.



Figure 6. *Demonstration of historical experiment with Magdeburg hemispheres*

The main goals of the Experiments for High School Students are to present and explain experiments that are usually not shown at school (for lack of time or equipment) and to promote physics to wide range of students, not only to science fans.



Figure 7. *Investigation of validity of Archimedes law*

The target group are upper secondary school students (tenth to thirteenth grade, fifteen to nineteen year old). Every year almost seven thousand of high school students accompanied by approximately fifty teachers come to see the programme. Each show takes seventy five minutes and three shows are presented every week during the school year.

Six selected parts from high school physics are presented: Mechanics, Optics, Electricity and Magnetism, Thermal Physics, Acoustics, Waves and Oscillations. The content corresponds to

school curricula and to teachers' wishes.

The experiments are performed by teachers and doctoral students from the Department of Physics Education.

Though the high school students are encouraged to take an active part in the demonstrations of experiments and their explanations it is not possible for everyone to touch the experiments with their own hands. Therefore The Interactive Physics Laboratory (IPL) was designed. Other reason for building IPL was lack of physics equipment of schools science laboratories and high cost of modern or more complex school apparatus. IPL is very well equipped by various sets of these modern apparatus and the visiting teachers and students can use them. That is probably the only way the high school teachers and students can do complex experiments with such apparatus even from advanced parts of physics.

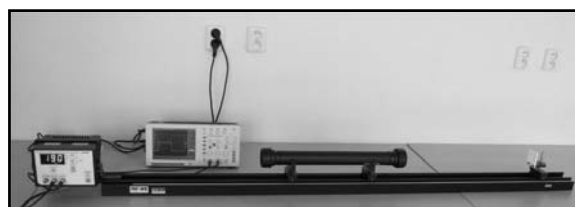

Figure 8. *Measurement of speed of light*

Small groups of high school students, approximately sixteen, with their teachers come to IPL to do laboratory work under supervision of teachers and doctoral students from the Department of Physics Education.

The high school students are split into four groups. Each group performs set of experiments and conducts measurements and presents the results obtained to their class maids. The sets of experiments are organised from the easy ones to more sophisticated ones and monotonically focused. For physics fans and more advanced students high levelled experiments are prepared.

Further processing of obtained data and of experiments done in IPL follows at schools after the students and their teachers return to their classes. Therefore seminars where the teachers are trained in advance are part of the IPL programme.

5. Courses for pre-schools

Young children are very inquiring, they want to know how things work and they love to do experiments. Therefore it is important to catch

their interest and motivate them to persist in science explorations and experimenting. The approach to them must be different from the approach to older children and students. They learn best by exploring of their own surrounding that they know and where they feel safe. That is a reason why the courses are done in the preschools and not in our faculty. The lector comes to the pre-school classes and works with the children there.



Figure 9. Teachers in IPL exploring Coulomb's law

The whole course is very interactive, it is based on doing hands-on experiments and on discussions with children.



Figure 10. Investigation of density of salted water

The courses are aimed on basic physics topics concerning air and its properties, water and its properties, optics, heat, magnetism and electricity. Some topics are covered in one lecture, some need more time.

The lecture is lead by a teacher from the Department of Physics Education. The majority of preschool teachers do not have training in

science and its education for that reason they do not have an active role during the lecture. They help with organisation, take care of the children and, what is very important, learn about the physics concepts themselves together with children. Before lectures the preschool teachers obtain handouts about topics discussed in the lecture. Their active role comes after the lecture when children draw pictures about what they had seen and done during the lecture. Every lecture begins by viewing of pictures from previous lecture and discussions about them. That is important for correction of the misconceptions the children may have and to fixing of knowledge they developed. Also an flyer for parents with short description of the lecture content is every time displayed at preschool.



Figure 11. Investigation of magnifying glasses

6. Summary

Among the wide range of outreach and popularisation activities the Department of Physics Education offers to pre-service and in-service teachers, students and public the above mentioned activities represent important addition to standard education. Part of them are designed for gaining of interest in science of small children, some of them enable sophisticated experimental work to high school students, others give an opportunity to pre-service teachers to increase their experimental skills, another are contribution of Department of Physics Education to in-service teachers training.



DRAMA-MANTLE OF THE EXPERT: CREATING CONTEXTS FOR TEACHING INTEGRATIVE INQUIRY BASED ELEMENTARY SCIENCE

Samar Darwish Kirresh

Walid & Helen Kattan Science Education
Project

Qattan Center for Educational Research and
Development

A.M. Qattan Foundation

Ramallah- Palestine

samardk@science.qattanfoundation.org

Abstract. *This paper explored the influence of Process Drama –Mantle of the Expert (MoE) on Palestinian lower elementary inservice science teachers' understanding of scientific inquiry, and their ability to plan and implement integrative, investigative and meaningful learning. It also explored teachers' awareness of their new role and how it affects the provision of opportunities for students to explore and construct meaning of science in relation to ethical and social responsibilities. Results are generally in a positive direction. Challenges teachers faced during the program were revealed. Also a general weakness in planning, implementing and integrating experiments in the teaching activities was also noticed.*

Keywords. Process Drama Mantle of the expert, inquiry, integration, learning.

1. Introduction

The challenge of teaching science in lower elementary classes lies in finding methods that will develop the children's thinking, practical skills and cognition, through engaging, creative and inquisitive methods. The Palestinian Educational System favours a class teacher for the lower elementary classes (grades 1 to 4). Usually they don't have science majors. Most have either arts or general elementary education qualification. Science is taught like every other subject matter leaving the children with no real scientific empowerment needed to drive their future interest in science or raise attention to its relation to their lives.

Most of the teaching is didactic. National text books are delivered by the Ministry of education

(MOE) to teachers as "ready to teach" [24] and teachers strictly follow content and activities [22]. Children are passive receivers confined to desks are arranged in rows to maximize teacher control. Student-teacher relationship is strongly hierarchical with students expected to follow orders. The slogan of integrative learning has been flagged shortly after the Palestinians took control of their educational system in 1994 with the implementation of the Integrated Learning Project in 1997. However the rationale of integration was not achieved and the integrated learning pedagogy was not established [2].

The Walid and Helen Kattan Science Education Project was launched in 2011 by the Qattan Center for Educational Research and Development (QCERD) at A. M. Foundation in Ramallah – Palestine. The project aims, among its targets, at improving the quality of science education in Palestine's schools and effectively transmitting its value into the wider society. QCERD has a long standing view of educational development concentrating on teacher empowerment and connected research. It has long worked in drama in education. A rich experience has been developed over the years which was put forward for the benefit of WHKSEP. Process drama Mantle of the Expert (MoE) has been part of the drama programme at QCERD with teacher exchange programmes between Palestine and the United Kingdom. WHKSEP is currently working through the system hoping it would help in achieving the project's aims of improving science teaching and learning.

2. Drama as a learning context

Education is no more conceived as curricula, content and skills but more a creation of a culture [14]. Students need to be liberated in school to be liberate individuals. They need to express opinion, be confident, share responsibility in their learning and develop perspectives of use and effect of their learning in life. They should be prepared for a world more about people who are inventive and can use integrative thinking to solve problems. They need to develop social interactive and collaboration skills, and the Socio-scientific knowledge and responsibility required in an emerging world of environmental literacy. Education has to offer contexts and experiences that can provide such a culture.

Drama has been introduced in education as a space that can allow for such an educational

culture. Swartz definition [6] provides an insight in an educator's view "Drama is experiential, active learning. Through drama, all students-including those with exceptionalities – can improvise action and dialogue using a set of teaching strategies that guide them to imagine, explore, enact, communicate and reflect upon ideas, concepts, and feeling at their own level of development" p.60. In drama students and teacher could engage in any context; endangered animals thriving for the survival of their species, environmental expert trying to solve a pollution problem or even space explorers isolated in a spaceship. In drama time place and character are open and can be recreated in imagined real – world contexts that serve learning purposes. It is the imagination that helps in realizing deep connections and responsibility [15]. And it is the imagination as Eisner [16] believes that cultivates a form of thinking leading to new creations. Kavanagh, Bartlett and Marshall [18] in their research on role of imagination in the natural science concluded that imagine is derived from perception and observation and has a poetic component in which new meaning is generated from past experience and observation. In drama adults can bring in their experience into the children's imagined world and the children take role in adult's world where they can express their experience and observation.

Drama had different forms in science education. It proved to be a successful media for teaching science [11]. It also had an effect on student's understanding of the Nature of Science [10][4] and learning of scientific meaning [23], and enabling students to learn science openly [9]. It can develop critical thinking [3]. Littlelyke [19] believes that it can be a powerful teaching strategy for enhancing meaningful learning and critical understanding which will help learners develop into scientifically literate adults sensitive for the world they live in and their impact on it.

3.1 Process Drama Mantle of the Expert

Process drama is a dynamic teaching methodology in which the teacher and the students work together to create an imaginary dramatic world and work within that world to explore a particular problem, situation, theme or series of related themes, not for a separate audience, but for the benefit of the participants themselves [8]. It is a student centred process orientation in which the process of creation is central rather than the shape of an end product.

Dorothy Heathcote was a pioneer in the field. Her views of drama were developed into what is known as Process Drama Mantle of the Expert. Central to her methodology and philosophy are **empathy** simply defined as putting yourself in somebody else's shoes, **role** with different role registers that in a way control the learning pace and direction and **drama** as a tool to promote cross-curriculum learning situations in the classroom. She represents a philosophy of teaching where feelings, reason, the individual and the whole, language and cognition are all dimensions that are holistically used [13]. Heathcote's method is marked by the constructed interaction of the class as a group rather than emphasizing the individuality of the individual. She thought of drama as a large group experience uniting all students' differences in a communal expression [17]. It is the active collaborative learning that draws on the children's social being and play in a real-life simulation that motivates students to learn.

MoE in the classroom works through a context that is ideally both playful and dramatic as well as a space in which learning occurs[1]. The teachers work is an intersection area [Figure 1] between three dimensions; 1) Drama for learning where students are involved in events and tensions. They are establishing different points of views.2) Inquiry learning with its collaborative process of investigation supported by the teacher and planned around inquiry questions. Opportunities are created for reflection and evaluation.

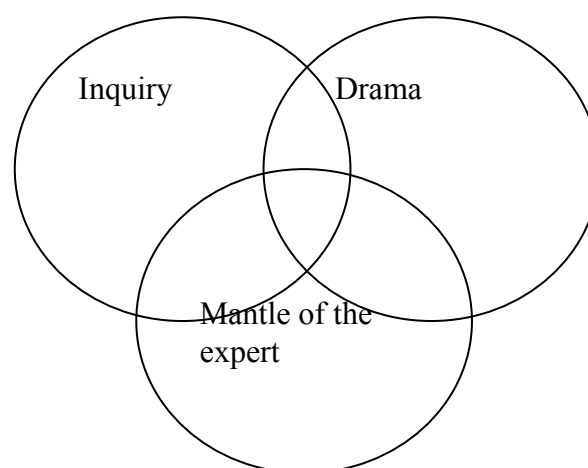

Figure 1. Dimensions of of MoE

3)Mantle of the expert elements of the team of experts realizing their responsibilities, power and capabilities to make decisions. They are working on a commission for a client thus requiring the

team to do various tasks[25].

Teachers and students would be playing and creating drama. They would be also exploring and learning [1]. Working in that area is what makes MoE a dramatic inquiry-based approach to teaching and learning. Dramatic inquiry is grounded in the student's curiosity about life. It is structured round inquiry questions as the primary inquiry stage in learning and teaching [National Research Council [20]. Dramatic inquiry is contextualized in fictional -real world narrative and events. Students find themselves collaboratively engaged in investigating and interpreting imagined real-life events as if the topic of investigation is their immediate responsibility. They experience inquiry as Edmiston explained: " *not only as a relatively emotionally detached researchers of ideas, but also as a group of thinking-feeling active participant-observers making meaning about pressing human concerns*"p.5[12]. He further explains how teachers focus inquiry from within the imagined events and how they extend and shape the students experiences when they join in the imagined context.

The presented approach to teaching empowers students to reflect critically about issues [13]. Empowerment as Boschi [7] tried to define it is the "can do" feeling of the learner accompanied by the satisfaction when it is done. It is where sharing knowledge and ideas engage all the class in a learning process that demands free expression. Empowerment entails a new role of the teacher and student which is more child centered. Heathcote knew that for a teacher to conduct a class with MoE gradual progression should be considered. Neither reading about it or seeing it is enough. It's class application that makes the difference. Teachers need to be inclusive in their language. It is when the children see their teachers engaged "with" them that they feel really empowered and enabled to become creative [7]. They will be watching their teachers while they are conducting dialogues experiments, discussions or solving their questions. The genuine expression of the teacher of interest in the students work will be motivating [3]. Teachers need to reflect on their work all the time and allow the students time to reflect too [5].

One important aspect of the Mantle is the integrative teaching approach it proposes. Real life- situation demand multiple resources to live them through. The drama context drives the students to connect and build upon knowledge

and skills from different resources and employ them in their new experience. Integration in drama is not only linking subjects when planning teaching. In the Mantle the drama, context, knowledge, skills, culture, person and experience inform each other to build a new comprehensive experience for the learner.

3.2 MoE methodology

The following is a simple description of the MoE methodology as details are beyond the scope of this paper. Description is based on the researcher's personal sharing in planning MoE in-service training sessions carried out by WHKSEP with Luke Abbott (Trustee of the National Association for the Teaching of Drama; NATD and Director of Mantle of the Expert Project) and the QCERD MoE experts. Also considered was Bolton and Heathcote [1995] definition of the core elements of MoE and the planning schemes at MoE website [25]. An example will be from a training courses carried out by QCERD with the teachers in this study.

MoE begins with an important **contract** between the teacher and students based on the students' agreement that it is a pretended situation where they will be running an **enterprise** as a **team of experts** in a **fictional world** to carry out a **commission** for a **client**.

MoE is built about a narrative context based on real-life –situations. The context is drawn from a curriculum content intended for exploration. The contents is selected across the curriculum. We chose to cover the unifying science process of form and function. We set our purpose. Different topics were to be covered. This was the intending learning content; biodiversity, body parts and external cover, forms of motion, body shape and streamlining, water cycle, condensation, evaporation, freezing and melting, solubility, solutions, mixtures, filtration, diffusion, mass and density. The choices covered content in different classes for training purposes. It also demonstrates the wide spectrum across the curriculum through which a teacher can work. The content is matched with teaching goals and listed as expected outcomes. A choice of the content joins up with the development of a scenario and a choice of real life situations that can open up different opportunities for the intended learning. Imagination and knowledge of students socio-cultural context are of importance at this point to lead into a choice of a meaningful learning context. In our training bird migration

through the Jordan River Valley was chosen. The main inquiry questions are set. Within our suggested context the following questions are an example; *Where do birds migrate to? What helps them through their travel? What would happen if the birds don't migrate? What do they need to carry out the journey?*

MoE is an integrative teaching approach and its contexts offer strong integrative learning opportunities. Geography (continents, transport, terrain, directions,), Arabic language (descriptive language) and Mathematics (measurement, units, geometry) were included as subjects. However the bird migration entails other concepts that can be integrated like borders, travel, teaming, responsibility to community and place to count a few.

A scenario is written. *"A piece of land used to have a pond of water. Migrating birds used to stop by on their way to rest and drink from the pond. This season the pond is dirty and scarce in water..... the Bird Watching Centre owning the land had a call from the Mediterranean Bird Migration Centre were they made it clear that a group of storks had a two weeks early start and was heading to Palestine on its way from Europe....".* Questions rise: *What are storks? Why do they migrate? What do they need? Where is Europe? How can birds travel such a distance?.....*

The **client** (Bird Watching Centre) asks for help (**commission**: refill the pond with drinking water suitable for the birds) from the students. The students care enough about the client's long term goals. They engage in activities through which they begin to **imagine** the fictional world. Learners and teacher interact predominantly as themselves. They **imagine** themselves as a group of **experts** (Team of Birdlife Experts). They collaborate to create the team, its tasks, its tools and equipment, workplace and jobs. The learners are engaged in activities that are both **curriculum tasks** and would be **professional practices** in the fictional enterprise. Tracking through the storks migration routes from Europe into the Jordan River Valley was one of the tasks the teachers were engaged in during training. They explored together making use of each other's knowledge. Scaffolding and learning were taking place. Everybody was busy on the task. Other tasks included inquiry hands on experimenting with wet and dry feathers and the effect of streamlining on motion. The teachers were making and exploring different models. Teachers scaffold the children's learning through

the knowledge building tasks and inquiry processes. The teacher must share power to position the students as **knowledgeable and competent colleagues** and ensures that the students position each other similarly.

Different tensions created within the dramatic context drive the students into new learning zones. It was suggested that; *A bird fell and broke it's wing....How can we help? What is the importance of the wing?*. All to be followed by suitable inquiry tasks. The team **reflects** all the time on their activities to **make meaning**.

4. Research Methodology

The research methodology is of a qualitative nature. Data was collected over a nine months period of training. Forty class teachers of the lower elementary (grades 1 to 4) from the Jericho Governorate in Palestine were included in the programme. They included Governmental schools(n=4) and United Nations Relief and Work Agency (URWA) schools (n=2). They participated in a 9 month professional development program between August 2012 and February 2013. There were 5 main training courses over the period. Focus was on specialized dramatic pedagogies and conventions related to MoE, scientific inquiry, questioning, building learning contexts and planning learning. The research aims at exploring the influence of MoE as an instructional framework on the teachers' 1) understanding of scientific inquiry, 2) ability to plan and implement integrative, investigative and meaningful learning contexts in their science classrooms, 3) teachers' awareness of their new roles, 4) how such roles may provide opportunities for students to explore science in relation to ethical and social responsibilities, 5) as well as opportunities to co-construct meaning of science within the addressed context.

Data sources included two stage progression open ended questionnaires. One targeted teachers' perceptions and views of science teaching as class teachers teaching science. The other explored their opinion on MoE as a new teaching strategy, its possibilities and constraints. Statistical results are submitted from the questionnaires based on joint opinions and answers. Focus groups were carried out after the first training session to investigate first responses of teachers to the introduced training ideas. Another session was held after the final planning session to explore their expectations as related to

class application. Teachers' conversations during the planning session were recorded. Session held with the teachers to discuss their individual lesson plans and narration of preliminary class applications were recorded. All recordings were transcribed. A short list of the main concepts introduced during the training sessions was prepared based on training plans and notes. Similar lists were drawn from the recordings of the planning session, and the teachers' plans and discussion, all to be later evaluated based on the comments of the researchers of WHKSEP and QCERD involved in the training.

5. Research results

Results indicate an understanding and implementation of MoE at different levels of dramatic depth. All participants demonstrated a general improvement in understanding of inquiry and in their ability to construct learning situations derived from students' socio-cultural contexts and lived experiences. Teachers were able to integrate inquiry questions as part of their lesson language. It was a good starting point to know that as class teachers teaching science 75% of them favored teaching science over other subjects, and 60% of them wrote that it was because of the activities that can be done. They all wanted, as they expressed during planning, to bring in "stories from the students close context and try to come out with an attractive context". Teachers who were able to carry out small scale applications believed "something new was in their classroom that they found interesting and fun to work through". One group even agreed that "teaching the unit on light and vision would take a month's work....through the Mantle it will be different". They generally had positive expectation. However there were outcomes that should be considered for future training.

(1) Teachers responded positively to inquiry as a teaching learning process. They might have not been able to carry the inquiry process through deep steps, however questioning and building learning about inquiry questions was an achievement to their credit. It was a challenge to be able to change the didactic language into the language of inquiry. Teachers were able to pose and use inquiry questions "How does planting trees affect humans? How would locusts harm us?" "What would happen if....? Why should we...? What would be the difference if....?" are example of the types of questions in their plans. Students questions however were a problem to

some. It was not related to the teachers' belief in questioning as they repeatedly discussed during the planning session that; "ideas flow during the drama activities and students questions begin to form. We must follow the questions...". It was more a time – curriculum constraint as they expressed at several discussions; "if we allow questioning the lesson would be over and the curriculum will not be finished". For them the time as related to curriculum was a limitation for allowing inquiry to take its course. There was absence of hands on activities necessary for inquiry. One of the four groups working during the planning session mentioned experiments on light, but when it was time for class application non appeared in the plans. Many opportunities stood out as chances for application and experimenting. Soil, stones and erosion in a Mantle working on creating a school garden and water in a Mantle on a piece of land that is to be rehabilitated after a fire and had a pond were opportunities for hands on applications. One teacher carried out a plant growth experiment that was well contextualized and employed Resources for inquiry are a limitation in many Palestinian schools with one of the Palestinian Governmental schools boarding 80 students in the Northern Jordan Valley having a **yearly** budget of a mere 400USD. 25% of the teachers stated material resources as a hindrance, 48% found limitations in the availability of space for learning activities. During our school field visits we found that all school laboratories regardless of the class levels or student number, were equipped according to the same list. There was a problem too with the provision of consumable supplies like chemicals. However when 35% of the teachers stated that the problem would not be solved if the necessary tools and equipment were available, the problem was not anymore limited to resources. The teachers seemed to need support in their new teaching situations that required new activities other than those they usually apply. There were results worth attention in the questionnaire on class teachers' perceptions and views on teaching science. 65% of the teachers favour that a science major teacher would take over the science lessons. 77% of them stated the reason to be that science major teachers have better skills and knowledge. 65% of them stated that what they do is "read out loud the experiment" and/or "do a demonstration". Water evaporation and condensation being the only mentioned example of an experiment by 35% of them. Resourcing their teaching activities

with hands on inquiry was a constraint. The inquiry workshop was able to reach the teachers as a concept, but they were not able to create or adapt existing resources.

(2) Looking across the lists of dram concepts and their evaluation revealed that teaching context, imagination, scenario, commission, client, team of expert, enterprise, role and inquiry questions needed to create the intended learning context were included in all discussions during the planning session. They were also marked in the plans and through teachers' narrations. During planning they deeply considered the children and searched through their imagination for scenarios, resources and tasks that are engaging and offer learning; "we will tell the students that we are going to set on trip....they will be excited". Another teacher argued "the piece of land we are to visit, how much information should we know about it?".

Their vision of lesson planning was changing; "every question we ask should target something" said one teacher "....we are not going to list the teaching goals as we used to" said another. "....it's now all about questions we pose to direct the children's knowledge" said the third in a planning session discussion. They did not reach the depth of self questioning that would lead them into the details of drama or the teaching activities. Student tasks were not discussed in details. Teachers agreed that the students would do research or draw or classify. True there was no clear rationale neither dramatic nor academic for the tasks, but they were integrating those learning tasks as part of their class teaching not as activities or assessments. They became resources of learning. It is a start considering that such activities were rarely considered for the age group. The teachers seemed to believe that they can improvise during their practice. However they faced the fact that detailed drama planning was a must when their attention was drawn onto learning chances that stood out in their plans and how they can be used either to integrate other learning subjects or experiments or produce material outputs like designing posters or photo galleries. This was a key point of discussion with the researchers during the discussion of the plans.

Drama and dramatic tensions were considered in planning and class application. An idea worth attention was the way two of the teachers introduced locusts into the children's drawing during their lunch break. It was surprising and triggering for the children to know more about

them and why everybody feared their arrival." *Are they Grasshoppers?*" they asked. It was a good employment of a current issue at the time as locusts were actually expected to reach the area. It was all over the news. A first grade teacher went in role as a land owner and as a guard during the sequence of introducing the context. He was impressed by the way the students responded to his role and how they were engaged in asking questions.

(3) Teachers had fears of sharing their power with the students. Though they realized and respected the new role as expressed in the focus groups and planning recordings; "we always wanted to deliver information. Now we want to help students search for knowledge" and some agreed that "we should change the type of relationship that exists between us and our students". However to let go was not going to be easy. Teachers had envisioned "loosing class control...." Based on the "large number of students per class" as repeated several times from day one in training. 48% of the teachers agreed that high numbers is the main constraint. 25% thought that the students might not accept the new forms. Another barrier was that "this work will be rejected....too much chaos". The main concern here was the school principal. 25% of the teachers asked for including principals in training hoping they would "understand the nature of the work" as "principals have to support this type of work or otherwise all our training through the past days would be useless...". WHKSERP included the supervisors in training to relieve the pressure of distant educational authorities and allow for the change. However for all the teachers who had class applications, it was a relief when the children got engaged in the learning activities. It was also important that the teachers allowed the space for the "chaos" to take its course when the children were given time to express their excitement of learning outside their desks. One of the teachers had a small number of students in the 3rd grade and asked students and teacher of the 4th grade to join in a learning experience. He described the group as "blended well" and "were out into a new learning environment".

Teachers tried to give the students space for inter student discussion and collaboration on tasks and decision making. It required some patience to shift out of the old paradigm. They were astonished by the students' response to the new learning strategy." *The children enjoyed the lessons and got engaged in the activities*

especially drawing the context details of their land and trees ...so much knowledge rose to the surface...I was surprised...".

4) MoE as an imagined real life context, helped the students to think within a positive ethical scope and attitude towards life in general and other creatures as well. They felt the responsibilities of the role. "we do not want to kill the locust..... just drive them away and protect our crops" was the first graders' stand that lead them to choose covering their crop with nets. The 3rd and 4th graders working on a design for their school playground found it necessary to consider disabled children in the design of the place. Another 1st grade group suggested that the guard will stand a long time in the sun and needed an umbrella. One of the teachers planned a context were the children would be in a difficult choice between using pesticides for better crops or killing the mice that were infiltrating the land. He was creating a need for a social ethical stand.

5)The choice of topics related to land and agriculture was wise for the preliminary stage for both teachers and students. It allowed maximum engagement and empowerment of members of an agricultural community. It related their learning to their lives. At the same time it revealed shocking information of the living space limitations forced by Occupation on the children who rarely leave their villages. They recognized the water source to be "the main tap". They live in an area surrounded by natural water resources that are beyond their reach and were left with that "tap" item as their water source. This brought in a new learning area that needed to be covered. The same limitation extended to a general knowledge of the destination of agricultural products of which they only repeatedly answered "the lorries carry them away". 1st graders were asking questions about their parents practices that they have long seen but seemed to have new meanings after the use of the agricultural context as a science learning context. One of the teachers reported this to be an outcome of the experience.

(4) 50% of the teachers found the curriculum a major challenge. It was "overloaded" and "does not allow time to be spent on the process of inquiry" as quoted from the focus group. They were referring to the National Text books. Integrative learning becomes more challenging within this vision of the curriculum. Though mentioned in their discussions, plans and trials during application, actually it was more making

use of existing knowledge rather than designing new integrative learning within the opportunities provided by their drama contexts. "the students can use their reading skills....the Arabic textbook units are on this topic...they can read them", "they can translate the words on the road signs into English", "this is a counting opportunity....they will count the number of trees of each type". Some believed that "Arabic is the central subject matter of which spring out the other subjects". Actually Arabic, English and Mathematics are considered the focal teaching subjects for lower elementary classes. This vision makes it difficult to start from a science subject into integrating language or mathematics. It's like reversing the teachers central thoughts. This is why they flowed easier into the a practice were science is a field of application.

6. Conclusion

MoE puts the teachers in the challenge of using all available resources whether material, cognitive, imagination, curriculum based content knowledge, pedagogy and skills into a teaching experience that is so inclusive. More work needs to be done on drama as a form and tool. Details of adult life experiences are appreciated as learning scopes. Teachers are currently thinking and applying MoE as a teaching activity rather than a comprehensive teaching strategy. It is a good step that they accepted the challenge of a new methodology. However overcoming this view is a challenge in itself. Accumulating experiences will induces a new model of thinking that might be able to help overcome current curriculum and time constrains. Dorothy explained that it is when the teacher repeatedly dares to practically experience MoE and find his own way through it, that he gains confidence [13].

Teachers are used to limiting themselves to text book experiments that are predesigned demonstrations. Teaching through inquiry requires new examples that need to be worked upon in the future. These are only the first steps. Our work with the teachers is ongoing.

7. References

- [1] Abbott L, Edmiston B, Workshop at the N.A.T.D. Conference; 1997; Bermingham, England.
- [2] Al-Ramahi N, Davis B, Changing Primary Education in Palestine: Pulling in several

- directions at once. *International Studies in Sociology of Education* 2002; 12(1): 59-76
- [3] Bannister P, Recognizing the Drama Classroom as a Site for Critical Social Inquiry. *Drama Research* 2012; 13(1): 3-21.
- [4] Boersma K, Goedhart M, Jong O, Eijkelfhof, editors. *The Effect of Using Drama in Science Teaching on Students Conception of the Nature of Science*. Netherlands: Springer; 2005.
- [5] Bolton G, Heathcote D, *Drama for Learning: Dorothy Heathcote's Mantle of the Expert Approach to Education*. Portsmouth, NH: Heinman drama;1995.
- [6] Booth D, Hachiya M, editors. *The Arts Go to School*. Ontario, Canada: Pembroke Publisher Limited; 2004.
- [7] Boschi R, *Mantle of the Expert: Potentialities of this Method in the Brazilian Educational System* 2011; Unpublished Ma Theses.
- [8] Bowell P, Heap B, *Planning Process Drama*. London: David Fulton; 2001.
- [9] Butler J, *Science Learning and Drama Process*. *Science Education* 1989; 73 (5): 569-579
- [10] Cakic Y, Bayir E, *Developing Children's Views of the Nature of Science Through Role Play*. *International Journal of Science Education* 2012; 34 (7): 1075-1091.
- [11] Dorion K, *Science Through Drama: A Multiple Case Exploration of the Characteristics of Drama Activities Used in Secondary Science Lessons*. *International Journal of Science Education* 2009; 31(16): 2247- 2270.
- [12] Edmiston B, *Mountains, ships, and Time Machines: Making Space For Creativity and Learning with Dramatic Inquiry in Primary Schools*; 2013
- [13] <http://www.moeplanning.co.uk/wp-content/uploads/2008/05/wearhead-report-1.pdf>
- [14] Eriksson S, *Distancing at Close Range: Making Strange Devices in Dorothy Heathcote's Process Drama Teaching Political Awareness Through Drama*. *The Journal of Applied Theatre and Performance* 2001; 16(1): 101-123.
- [15] Flemming M, Merrell C, Tymms P, *The Impact of Drama on Pupils Language, Mathematics and Attitude in two Primary Schools*. *Research in Drama education* 2004; 9(2); 176-197
- [16] Greene M, *Realising the Imagination: Essay on Education, the Arts, and Social Change*. New York: Teachers College Press; 1995.
- [17] Harris E, *Lessons from the Arts: A Review of the Arts and the Creation of Mind*. Virginia, USA: R.R. Donnelly & sons; 2002.
- [18] Johnson L, O'Neill C, editors. *Collecting writing on Education and Drama*. Illinois, USA: Northwestern University Press; 1984.
- [19] Kavanagh S, Bartlett Ch, Marshall M, *Imagination in the Natural Sciences: Pattern Recognition, Transformation and Expression*. *Proceedings of the 4th International Conference on Imagination and Education*; 2006; 12-15; Vancouver, BC, Canada.
- [20] Littledyke M, *Drama and Science*. *Primary Science Review* 2004; 14-16
- [21] National Research Council, *Inquiry and the National Science Education Standards: A guide for Teaching and Learning*. Washington, DC: The National Academies Press; 2000.
- [22] O'Neill C, *Drama Worlds: A Framework for Process Drama*. Portsmouth, NH: Heinman; 1995
- [23] Qattan Center fo Educational Research and Development (QCRD), *Educational Reform and the Construction of Meaning in Palestinian Schools: An Ethnographic Study of six Governmental Schools*. Palestine: QCRD; 2001
- [24] Varelas M, Pappas Ch, Tucker-Raymond E, Kane J, Hanks J, Ortiz I, Keblaw-Shamah N, *Drama Activities as Ideational Resources for Primary -grade Children in Urban Classrooms*. *Journal of Research in Science Teaching* 2010; 47 (3): 302-325.
- [25] Wahbeh N, *Teaching and Learning Science in Palestine: dealing with the new Science Curriculum*. *Mediterranean Educational Studies* 2003; 8(1):135-159
- [26] *Mantle of the expert.com*:
- [27] <http://www.moeplanning.co.uk>



APPLICATION OF THE FLIPPED CLASSROOM MODEL IN SCIENCE AND MATH EDUCATION IN SLOVAKIA

Jozef Hanč

Department of Physics Education Research,
Institute of Physics,
P.J. Šafárik University in Košice,
jozef.hanc@upjs.sk

Abstract. *At the present the flipped classroom model of teaching and learning became one of mainstreams in science and math education research.*

In essence, “flipping the classroom” means that typical activities used to occur in class (like lecturing, explaining, simple demonstrations) is exposed and accessed outside and in advance of class (e.g. at home). The class becomes the place for interactive learning including authentic hands-on activities (inquiry based lab work, interactive demonstrations) and minds-on activities (inquiry based problem-solving, peer and class discussion, or debates).

In our contribution we explain pedagogical and practical details (tenets, benefits, pitfalls) of the flipped classroom based on our three years long direct experience from science and math education in Slovakia at secondary and higher education and training pre-service and in-service teachers. At the same time we explain our view of the technology and teaching methods in the flipped classroom.

Keywords. Science and math education, blended learning, flipped classroom, question driven instruction, digital technology

1. Introduction

Information revolution and digital technology dramatically transforms our society, ways how we work, how we communicate or how we spend our leisure time. These days digital technology is practically everywhere, touches our everyday lives. At the same time it changes demands for skills dealing with active successful life, so the presence of technology in education is inevitable (e.g. [1]).

In connection with using technology in education our department became an integral part of several significant educational projects for

training in-service teachers which are just finished or still currently running:

- *the European 7FP project „Establish”* [2,3], where the main objective is dissemination and use of the inquiry-based teaching method for science (enhanced by ICT) with second level students (age 12-18 years) on a large scale in Europe by creating authentic learning environments, involving all stakeholders;
<http://www.establish-fp7.eu/>
- *the national projects „Modernization of the education at primary and secondary schools”* [4], with the primary goal to raise awareness and capability of more than 6800 in-service Slovak teachers in ways how digital technologies can change classrooms into modern student-oriented environments for training, developing and enhancing required student’s skills;
<https://www.modernizaciavzdelavania.sk/>
- *the science popularization project „Sciencenet”* [5] that has formed the long-term strategic partnership with high schools called Sciencenet and whose one of main objective was to provide novel education and popularization means (esp. new digital technologies) for high school partners and to train their teachers in using them.
<http://www.sciencenet.upjs.sk>

However it is important to realize that the extensive educational research has shown in many cases [1,6–11] that the effectiveness of digital technologies depends strongly on the pedagogical ways in which teachers use them.

Many well-established and sound pedagogical approaches can be successfully employed in the so-called blended learning [10], where from the viewpoint of technology the key role is played by Web technology. This pedagogical strategy is nothing else as an effective and powerful fusion of face-to-face classroom learning and out-of-class online learning.

Among the most widely used approaches in science and math blended learning belong *Just-in-Time Teaching* [8], *Small group learning* [12], *Question driven instruction* [7] or *Flipped classroom* [13].

Slovak teachers (especially in physics) have been introduced with teaching materials dealing with blending learning in the form of Just-In-Time Teaching and Question driven instruction in mentioned national projects „Modernization of

the education at primary and secondary schools” [14] and “Sciencenet” [5]. During running these projects some pedagogical problems have occurred, so we have also started to train some groups of teachers in the blended learning based on the flipped classroom model.

In this article we explain some pedagogical and practical details of the flipped classroom model of teaching and learning which comes from our three years long direct experience from science and math education in Slovakia at secondary and higher education.

2. Theoretical framework, teaching methods and technology

2.1 Concept of the flipped classroom

According to Bergman and Sams [13], two American teachers of chemistry, who coined the term *flipped classroom*, the flipped classroom model of teaching and learning (briefly also the flipped learning) means, that which is traditionally done in class (like exposition of new content, lecturing, listening, making notes, comprehension, simple demonstrations or teacher’s experiments) is now done at home, and that which is traditionally done as homework (like solving problems, doing projects, creative writing) is now completed in class.

From the theoretical viewpoint the basic idea of the flipped classroom model consists in the well-known revised Bloom taxonomy [15], which classifies cognitive work in two dimensions – abstractness of knowledge and difficulty (level) of thinking skills.

During the flipped learning, in accordance with this taxonomy, students are doing simpler (lower) thinking activities (gaining knowledge and understanding) and acquiring more concrete knowledge (like factual) mainly outside of class, and practicing the more difficult (higher) activities (applying, analyzing, evaluating, creating) and constructing more abstract conceptual or metacognitive in the class, where they have the support of their peers and instructor.

As a strong benefit the flipped learning has the effect of creating extra time, which in class allows instructors moderating discussions and debates about more difficult topics, identifying and resolving students’ misconceptions, doing more complex hands-on activities or training key skills. In other words the flipped learning maximizes the value of face-to-face time – the

scarcest learning resource from viewpoint of interactivity. A summary of typical activities during the flipped learning is presented in Table 1.

Time	Activities
prior to class	<p>Reading blog, magazine, book, textbook; Writing notes in Cornell style Watching video-lectures, TV news, movie scenes, video manuals or tutorials; Doing simple experiments, simulations or remote experiments, field trips; Playing games; Visiting museum, exhibits, Finding out information, Doing research, Communicating via interview, sms, videoconference, social network;</p>
during class	<p>Interactive demonstrations Inquiry based activities and lab works, Workshop experimental activities,</p> <p>Inquiry based problem-solving, question driven (peer instruction) activities, peer and class discussions or debates,</p> <p>Project based activities, Cooperative group problem solving Creative writing, Critical thinking training</p>

Table 1. Activities in the flipped classroom

The flipped classroom model has also several disadvantages, but there are also techniques how to eliminate them to a negligible level [16].

2.2 Question driven instruction and the learning cycle approach

Question-driven instruction and its activities belong to very appropriate in-class activities of the flipped learning. This interactive teaching method using classroom response systems (e-voting) was created by the physics education research group of University of Amherst (Beatty, Gerace, Leonard, & Dufresne) [7,9]. The typical class session in such case is structured around three or four question cycles per 45-min long time slot. Each question cycle includes the following steps:

1. Posing a question (problem) by the instructor
2. Small-Group work, discussion on the problem

3. Collecting answers of students by e-voting
4. Displaying the histogram of answers without revealing the correct answer
5. Opening up and moderating a class-wide discussion
6. Closure activities (typically reposing the same question or sending a related question; summarizing the key points or giving a micro-lecture)

From the viewpoint of the well-known constructivist ideas of J. Piaget [6,17,18] we have decided to adjust our flipped learning to a very successful teaching design representing a form of inquiry-based teaching, *the Learning Cycle approach* [18,19]. This approach, developed by Robert Karplus and his team, divides the activities of instruction into three phases (Fig. 1).

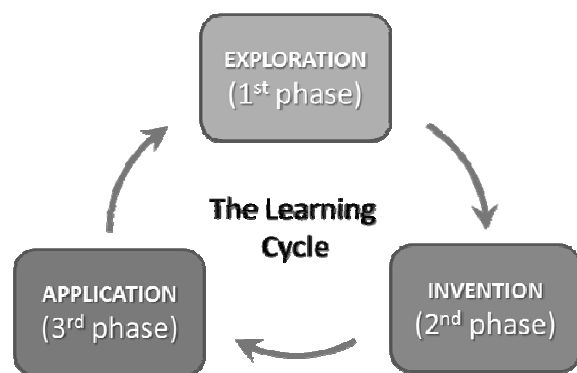

Figure 1. A teaching strategy called the learning cycle proposed by Karplus and his team

In the first *exploration* phase (usually through hands-on activities) students alone or in small groups are first given experience with a concept to be developed. This experience is getting without any special instructions, guidance or instructor's intervention.

After that the *conceptual invention* phase follows where students with/without teacher's guidance derive the concept from the previous experience. This phase usually brings students together (to class) with the instructor playing a moderator role.

The final phase, the *application* phase, gives the student the opportunity to explore the usefulness and application of the concept in other circumstances and conditions.

The learning cycle approach is successfully applied in great variety of educational settings, from science subjects (math, physics, chemistry, biology) to humanities, at all levels of education

and in groups ranging from 5 to 150 students.

2.3 Technology in the flipped classroom

Implementation of the flipped learning in practice means creating conditions for completing various activities. As you will see in particular examples mentioned in next section 3 (or in [13]) the flipped classroom depends heavily on technology, especially Web 2.0. For managing education it is appropriate to use an LMS like Moodle or based on [20] we are trying to use the social network Google+ and blog (Blogger).

In case of not using LMS any communication and discussions can be provided by social network Google+. Students are doing experiments via computer interactive simulations (Geogebra, Phet, Google maps), digital probes and special software. Special software is also used in case of recording videos via screencasting (Camtasia, Jing, OneNote). Storing, hosting, e-voting is easily performed by free cloud services (Youtube, Google disk, Polleverywhere).

3. Two flipped-learning examples

3.1. Calculus in higher education

Usually the higher mathematics as the calculus of single variable is taught at universities by deductive scheme: definition of a concept, theorem (property of the concept), proof (rigorous logical argument), and example (concept illustration). This method invented by ancient Greeks has great importance to mathematics itself, to its theoretical foundations. However, if we look at the deductive learning in light of the constructivism and the learning cycle, such approach cannot principally work for majority of students. For example in traditional deductive introduction to the key calculus concept derivative, students should be familiar with the theory of limits based on the delta-epsilon technique. And as a result many science students (especially those who are not majors in math) if they are able to find derivatives, consider the concept mysterious, do calculations only mechanically and fail to solve practical science problems because they have often little idea what derivatives mean.

Students do not understand calculus not only conceptually, but have also problems with their own metacognition about learning science and

math. In other words students have wrong ideas about answers to questions like what does it mean to understand math and physics? Is physics or math about memorizing and applying rules and equations or about reasoning and making sense of the physical world? Do I understand what does it mean if I am doing science and how scientific method work?, etc.

The second important problem of our instruction is a sample of students who came to study science at our University. According to our test of mathematical literacy from high school (administrated every year before the course) average quality of students continuously drops and gap between what students need to know and they know extends. Moreover our calculus classes are more and more heterogeneous in skills and performance. Many of our students start to struggle with course content after a few lessons.

If we tried to adjust our instruction to average students, we run immediately into problems with time and it was practically impossible to follow our syllabus. Time becomes immediately the scarcest learning resource.

Another frequent and not minor problem in university courses deals with absentness of a teacher, students or mere instruction (lectures, recitations) due to holidays, illness, school or scientific events.

We have tried to solve these pedagogical problems in our course Fundamentals of math for physicists using the flipped learning applying ideas of the calculus reform [21] which took place in US during the 80's and 90's of the twentieth century and completely re-thought the calculus curriculum for non-majors in math.

Most important for us were two central ideas of this reform which are fully consistent with the-learning-cycle strategy: (1) calculus: a pump, not a filter (less details in logical rigor, but clear and transparent in presenting key ideas; substantially more real applications), (2) using technology, inductive learning method and "Rule of Four" for presenting ideas at the same time graphically, numerically, symbolically and verbally [21,22].

To get better idea we present an example of the flipped calculus class connected with our introduction to the concept of derivative.

In the first exploration phase, prior to class, students start with motivational reading, Conquer the third pole, from the science popular magazine Geo about the first successful attempt to climb the highest mountain in the world. They are also said that this activity is important in getting good

intuition and idea about derivative.

To get own first experience student also follow Hillary's and Norgay's expedition to Mount Everest virtually in a simple interactive hands-on activity – doing 3D simulation of the climb complemented by watching real Youtube videos and photos offered by Google maps (Fig.2). Exploring on own students submit their answers to a simple task: Try to draw a profile of Mount Everest during Hillary's and Norgay's climb of Mt. Everest and mark the most difficult point of this climb. Give reasons for your choice.

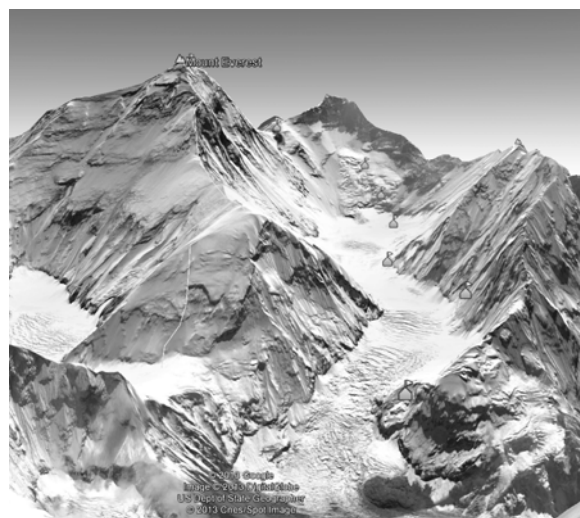

Figure 2. A simple interactive exploration activity using 3D Google maps

The exploration phase continues with watching our mini YouTube video-lecture (10 minutes) about "steepest location" of Mount Everest's profile. Students prepare and submit own notes by using Cornell note-taking method [13] together with completing a simple assessment rubrics containing their reactions. The result of the phase is student's clear and intuitive idea that the derivative of a function at a point means geometrically a synonym for the slope (steepness) of the profile (curve or graph) or physically an instantaneous rate of change of considered quantity in time (or instantaneous growth).

In the second invention phase, in class, thanks to in-class minds-on and hands-on activities (Geogebra simulations) students in question driven instruction are trying to answer a series of questions using an e-voting response system based on their mobiles and web service <http://www.polleverywhere.com>

This phase leads students in formulating the exact calculus definition of the slope of linear

function and also a geometrical definition of slope of nonlinear function as the slope of the line tangent to the curve representing the graph of the function.

The invention phase is finished again out of class where students watch our Youtube collection of four recapitulating videos and submit own Cornell notes summarizing their learning.

In final application phase (again in the form of question driven instruction) students extends the range of applicability of the concept and finish with the limit definition of the derivative. The limit concept is discussed only intuitively as expressing the slope of the line between two infinitesimally close points on the graph of the function.

3.2 Popularization of science at secondary schools

One of objective of the partnership Sciencenet (the project mentioned above) is to realize regular popular scientific activities like lectures, workshops, and public science days for students and their parents, which have a strong potential to show fascinating world of physics and science. As a successful example of such activities becomes an interactive popularization lesson *Could Spider-Man really stop a subway train?*, which can be also treated as the form of flipped classroom based on the learning cycle mentioned above. The main objective of the lesson is to show the power of applying scientific models to real situations. In this case students will invent and apply a simple kinematical model of the situation – constant deceleration model.

At least one day before the popularization action and out of class students are encouraged to create informal groups and asked to complete the first exploration phase of the learning cycle. Without any special instructions or guidance or intervention they are getting own experience by watching one of Spider-Man movie scenes (5 minutes long), when Spider-Man stops a New York City subway train. Investigating the video students submit their answers to this simple task: Try to find in the video as much scientific information as possible.

The beginning of the face-to-face interactive lesson represents start of the second invention phase of the learning cycle. Using question-driven instruction students try to make sense of the data collected during the exploration phase and connect to the key question: *Could Spider-Man really stop a subway train?*

Using e-voting for answering multi-choice questions together with peer and class-wide instruction and applying the Ockham razor (metaphorically illustrated by a joke about a spherical cow) they develop and invent a simple kinematical model of the situation (“constant deceleration model”). With teacher guidance they find that the power of the superhero is not exaggerated at all and it is comparable to strength of a very mighty gorilla.

Later students deploy the model in a real life situation (airbag in car) which represents the third last application phase of the learning cycle. As homework in a simple lab activity (video-analysis of a crash test according to video manual) students complete the application phase by checking in the developed model.

4. Conclusions

At the present the flipped classroom model of teaching and learning becomes one of mainstreams in science and math education research. This approach allows instructor to create and maximize the use of the scarcest learning resource from viewpoint of interactivity - classroom time. It means more student-student and student-instructor interactions, students learning at own pace, addressing absenteeism and helping struggling students.

Our first results supports the conclusion that the flipped learning can result in greater achievement in math and science, better understanding and retention of concepts, improved attitudes toward science and science learning, better reasoning ability, and superior process skills than would be the case with traditional instructional approaches.

5. Acknowledgements

I would like to thank especially to my colleague, collaborator and friend Slavo Tuleja from Grammar school in Humenné, for continuous sharing and exchanging knowledge, inspiring ideas and experience dealing with the flipped learning at all levels of education.

The presented results are based on our work in several projects: (1) the international 7FP project ESTABLISH (European Union’s Seventh Framework Programme FP7/2007-2013 under grant agreement n° 244749), (2) Modernization of the education at primary and secondary schools (ITMS project codes: 26110130083, 26140130013, 26110130084, 26140130014) supported by the European Social Fund, (3) and finally project SCIENCENET, financially

covered by the grant LPP-0134-09 of Slovak research and development agency (APVV) in the program for Human Potential Support in R&D and Science Popularization.

6. References

- [1] Bell RL. *Technology In The Secondary Science Classroom*. National Science Teachers Association; 2007.
- [2] Ješková Z, Kireš M, Ganajová M, Kimáková K. Inquiry-based learning in science enhanced by digital technologies. *Proc. Iceta 2011, Stará Lesná, The High Tatras, Slovakia: 2011*, p. 115–8.
- [3] Kireš M, Šveda D. Scientific Literacy for the Information Society. *Proc. Iceta 2012, Stará Lesná, The High Tatras, Slovakia: 2012*, p. 193–6.
- [4] Hanč J, Kireš M, Šveda D. The digital literacy and key competencies as the cornerstones of primary and secondary education modernization. *Proc. Iceta 2011, Stará Lesná, The High Tatras, Slovakia: 2010*, p. 411–6.
- [5] Hanč J. Interactive science popularization lectures using modern technology in the partnership Sciencenet (in Slovak). *Proc. Quo Vadis Educ. Sci. Technol. Second. Sch. 2010, Bratislava: 2010*, p. 82–8.
- [6] Donovan MS, Brandsford JD, editors. *How Students Learn: Mathematics in the Classroom*. Washington, D.C.: The National Academies Press; 2005.
- [7] Beatty ID, Gerace WJ, Leonard WJ, Dufresne RJ. Designing effective questions for classroom response system teaching. *Am J Phys* 2006;74:31–9.
- [8] Simkins S, Maier M, editors. *Just in Time Teaching: Across the Disciplines, and Across the Academy*. Stylus Publishing; 2009.
- [9] Bruff D. *Teaching with Classroom Response Systems: Creating Active Learning Environments*. John Wiley & Sons; 2009.
- [10] Glazer FS, editor. *Blended Learning: Across the Disciplines, Across the Academy*. Stylus Publishing; 2011.
- [11] Seel NM, editor. *Encyclopedia of the Sciences of Learning*. Springer Science; 2012.
- [12] Cooper JL, Robinson P, editors. *Small Group Learning in Higher Education: Research and Practice*. New Forums Press; 2011.
- [13] Bergmann J, Sams A. *Flip Your Classroom: Reach Every Student in Every Class Every Day*. International Society for Technology in Education; 2012.
- [14] Ješková Z. *Using ICT in physics instruction at secondary schools (in Slovak)*. Košice: Elfa; 2010.
- [15] Anderson LW, Krathwohl DR, Bloom BS. *A taxonomy for learning, teaching, and assessing: a revision of Bloom's taxonomy of educational objectives*. Longman; 2001.
- [16] November A, Mull B. Flipped learning: A response to five common criticisms. *Eschool News* 2012;15:62–8.
- [17] Redish EF. *Teaching Physics with the Physics Suite CD*. Wiley; 2003.
- [18] Fuller RG, Campbell TC, Dykstra, Jr. DI, Stevens SM. *College Teaching and the Development of Reasoning*. Charlotte: Information Age Publishing; 2009.
- [19] Marek EA. Why the learning cycle? *J Elem Sci Educ* 2008;20:63–9.
- [20] Erkollar A, Oberer B. Trends in Social Media Application: The Potential of Google+ for Education Shown in the Example of a Bachelor's Degree Course on Marketing. In: Kim T, Adeli H, Kim H, Kang H, Kim K, Kiumi A, et al., editors. *Softw. Eng. Bus. Contin. Educ.*, vol. 257, Springer Berlin Heidelberg; 2011, p. 569–78.
- [21] Haver WE, editor. *Calculus: Catalyzing a National Community for Reform*: Awards 1987-1995. The Mathematical Association of America; 1999.
- [22] Hughes-Hallett D, Gleason AM, Lock PF, Flath DE, Gordon SP, Lomen DO, et al. *Applied Calculus*. John Wiley & Sons; 2009.



MOLECULAR BIOLOGY AND GENETICS - ONE OF THE OVERLOOKED THEMES IN HIGH SCHOOL PRACTICAL BIOLOGY COURSES IN CZECH REPUBLIC

Vanda Janštová¹, Lukáš Falteisek²

¹ Faculty of Education, Charles University in Prague,

² Faculty of Science, Charles University in Prague, Department of Zoology, Czech Republic,

vanda.janstova@natur.cuni.cz

Abstract. *Students' interest in science has been declining in the western countries. The need of science knowledge among citizens is growing as we have to make decisions based on it in our everyday lives. Therefore we should motivate young people towards science. One of the possible ways is to get pupils engaged in practical work. Molecular biology and genetics are two of the key disciplines to understand new approaches but there are nearly no practical courses tough for them. I will introduce practical courses (device dependent and independent)we teach to future biology teachers as well as experienced teachers.*

Keywords. biology, genetics, molecular biology, practical courses

1. Introduction

We have to keep pace with a quick progress in science which brings us new technics and new knowledge. There are whole new scientific branches emerging. The teaching concept has also changed from the attitude that science is important only for those who want to become scientists to the belief that science is necessary for everybody[1]. This is because we all face many decisions that can be made and situations that can be solved based on science knowledge and understanding science principles and/or methods. These can be connected to health issues, global changes, sources of energy or others. On the other hand, students' interest in science has been declining in the whole western world including Czech Republic for last decades [2]. There are several possibilities how to address

this problem and regain students for science schools[3]. The main, which can be of course combined, are: to use Inquiry Based Science Education (IBSE), to get families and local communities involved in education, to motivate more girls to engage with science, to motivate teachers to share examples of good practice, teachers' lifelong education and new approaches and teaching methods[1]. Another way how to motivate students towards science is to teach the subject using practical courses [4], [5], [6], [7].

2. Biological practical courses in Czech Republic

There are many traditional practical courses and many websites or journals where to get inspired. Future biology teachers on Faculty of Science, Charles University in Prague have to attend and also teach several practical courses during their studies. This still may be not sufficient as a pilot survey among biology teachers showed there are some biological disciplines with nearly no practical courses taught. Number of theoretical lessons devoted to some biological discipline was compared to number of practical lessons with the same focus. For example, nobody taught practical course in virology[8]. Of course, it is not possible to have practical course with viruses at school but one can for example use models to facilitate the apprehension of viral genetic shift [9] which is as well as other themes connected to misconceptions [10]. Other biological disciplines most of the teachers teach only theoretically are ecology, molecular biology and genetics. This can not be generalised as the sample was 19 high school biology teachers from 18 different high schools in Czech Republic [8]. The representation of teaching methods used during science lessons was compared in Czech Republic, Australia, USA, Japan and The Netherlands during TIMSS in 1999 [11]. The lessons were videotaped and analysed. The most practical activities were found in Australian and Japanese lessons, the least in Czech Republic and The Netherlands. Moreover pupils had the smallest opportunity to record and interpret data in Czech Republic [11]. It is therefore easy to imagine that science seems not to be connected to real life. When students were asked to arrange school subjects from the most favourite (No. 1) to the least favourite (No. 14), biology got No. 9 among girls and No.10 among boys which is quite alarming [2].

3. Molecular biology and genetics

In the next part of this paper, we will focus on molecular biology and genetics. We will discuss the importance of these disciplines and the way these can be taught.

3.1. Importance of molecular biology and genetics

There has been a rapid development of knowledge in the area of molecular biology and genetics in the last decades. We can hear about themes like cloning, GM food, stem cell in the news and we should be able to form our opinion without being manipulated. Everybody can be faced for example with the need to interpret the result of a screening. It is therefore important to have some basic knowledge even if our life or profession is not directly connected to science. Students' conceptions concerning molecular biology and genetics have been investigated to find out what are they before and after different lectures and which approach works better [12], [13], [14]. It was also shown that students' understanding of the process by which genetic information is transferred is very poor and the students lack basic knowledge about structures like cell, chromosome, or gene [14].

3.2. How to teach molecular biology and genetics

There are also practical courses both laboratory and computer animations recommended even for high school students [12], [15], [16]. Also a different approach can help to gain better learning results as it was shown with jigsaw cooperative learning [17].

4. Czech experience, Charles University in Prague

We will describe our experience with the molecular biology and genetics practical courses taught on Faculty of Science, Charles University in Prague. We will mention courses designed for high school students, future teachers of biology and experienced biology teachers. Some of the practical courses are computer based with no more equipment than computer connected to internet needed. Others are laboratory and are dependent on laboratory equipment.

4.1 Computer based practical course

The computer based practical course has been taught to future biology students for 3 years. It simulates some activities a scientist would do when working with sequences and on-line databases.

The aims of this practical course are following: the student explains how protein sequence is coded by DNA sequence, student uses some basic on-line tools to work with sequences (BLAST, Expasy, Sequence Massager), student describes how fusion proteins can be made and names one example.

Students work in pairs or individually. They start with a sequence of a real bacterial plasmid, real primers and a question "what is the sequence these primers can be used to amplify?" During the practical course, the students find out they are working with a sequence that starts with ATG codone. Blasting this sequence reveals similarity to several vectors and looking closely allows us to name the protein coded – Enhanced green Fluorescent Protein (EGFP). This version has a few mutations compared to GFP which enhanced the fluorescent signal obtained. Now students can answer the following questions: Have you heard about GFP? What is the function of this protein? In which organism is it found? How is it used by scientists and what is the goal of this usage? The information is summarized for example in [18]. The last step is to look at its' structure. We can use a Cn3D free-ware in which we enter the Protein Data Bank (PDB) ID (2Q6P). The structure of a „barrel“ made of beta sheets can be rotated by mouse (Fig.1).

There are other examples of *in silico* biological courses like making a phylogeny tree and searching for related species [19]. This type of a *in silico* practical course was also a part of a school level of Biological Olympiad in Czech Republic last year. In this case the focus was on proteins their sequences and structures.

4.2 Laboratory practical courses

We have been using several laboratory practical courses focused on molecular biology because we believe this is useful for students and helps them to understand the basic genetic principles. Molecular biology and genetics practical courses can be also designed as inquiry based. This can be done by giving reasons for the individual steps and discussing what would happen without a specific step in the process. This approach was

shown on a common DNA isolation from a plant tissue [20]. We have been using a slightly different approach when besides this reasoning students can actually choose their own way how to reach the result. The problem is following. Students are provided with four different bacterial plasmids numbered 1 to 4. Their task is to distinguish among them using restriction endonucleases and agarose gel electrophoresis.

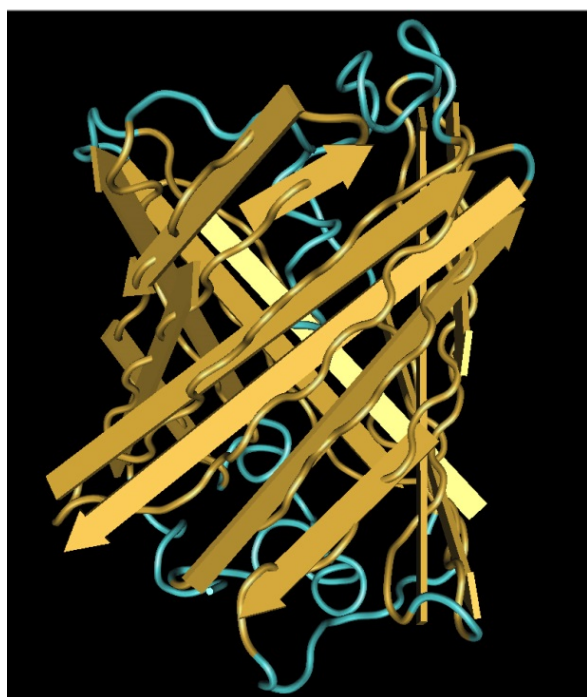

Figure 1. “Barrel” structure of a green fluorescent protein made in Cn3D. Arrows show beta sheets, lines show alpha helices.

Students can choose their own combination of the enzymes to gain recognisable products. There are more correct solutions but some combinations also give products of similar length and therefore the plasmids can not be recognised. The plasmids are again molecules used in real laboratory research (Fig.2).

After the restriction, students analyse the length of each fragment and compare it to the expected length. The result is assigning each number of a plasmid to its` name (code).

In our experience, students choose combinations that enable them to distinguish individual plasmid. This practical course serves as a starting point of a discussion about genetic modifications, expression of fusion proteins and their role in our everyday life etc.

After the restriction, students analyse the length of each fragment and compare it to the expected length. The result is assigning each number of a

plasmid to its` name (code).

In our experience, students choose combinations that enable them to distinguish individual plasmid. This practical course serves as a starting point of a discussion about genetic modifications, expression of fusion proteins and their role in our everyday life etc.

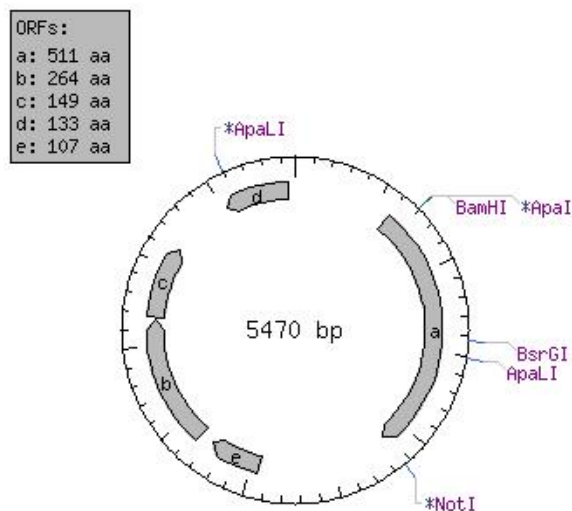

Figure 2. Example of one of the bacterial plasmids used in the practical course described. Restriction sites of the restriction endonucleases used are marked. The size (length in base pairs) is in the middle.

Another possibility is to use a similar procedure for every student supported and clarified by discussion and reasoning [20]. We have simplified one such practical course determining alleles of ccr5 gene in human [15] which was originally described by Thomas [21]. Approx. 950 both to high school students and university students undertook this practical course during the last tree years. The ccr5 gene was chosen because there is a 32 bp long deletion described which can be detected using PCR (polymerase chain reaction). Because the receptor is not used only by a chemokine for which it is designed but also by a HIV (as a co-receptor) [22] it is very interesting and also important. Moreover this deletion prevents the protein to function as a HIV co-receptor [23]. Students use their cheek epithelial cells to amplify the part of ccr5 gene which can have the deletion. PCR products are analysed using agarose gel electrophoresis and the results are discussed. To prevent students from gaining sensitive personal data, the unmarked samples can be mixed and therefore anonym. The gene was also chosen because the deletion does not cause any clinical demonstration[21] so the ethical issue is

minimalized. Interestingly, the frequency of the heterozygotes varies across Europe and is zero on other continents [24]. This might be due to past selection because other pathogens (e.g. smallpox) use CCR5 as a gate way to a cell [25]. The frequency of deleted alele in Czech Republic is around 10%. There are usually between 10 and 20 students in one group so it is not a problem to find heterozygote or even homozygote with deletion (one in 100) (Fig.3).

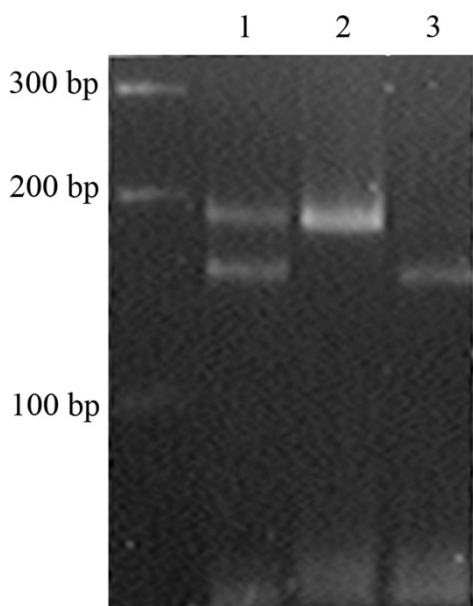

Figure 3. An example of three possible results of agarose gel electrophoresis. Normal length PCR product 188 bp (upper band, line 1 and 2), deleted alele product 156 bp (lower band, line 1 and 3). Left line represents standard of molecular weights: 100 bp, 200 bp, 300 bp. Adapted from [15].

There has been one unique clinical case described in which *ccr5* deletion played an important role. A transplantation of peripheral blood stem cells from a homozygous CCR5- Δ 32 donor to HIV-1 positive was done. The patient had no viral rebound 20 months after the transplantation and the end of antiretroviral therapy [26].

Several topics are discussed during this practical course. These are the methods used (mainly PCR and its use in medicine, archeology, criminology), genetics of populations, mutation and the possibility of providing some positive effect, drug design and anti-viral therapy.

Another similar practical course was described by Imperial and Boronat [16] and shows how to detect Rh factor. It again instigates explanation

of PCR diagnostics, prenatal diagnostics, determination of blood groups and more.

4.3 Practical courses for high school students

These laboratory practical courses were tested and taught on high schools both in Prague (students come to the faculty) and different Czech towns (we come to the high school with all the equipment needed). We are currently testing the possible impact of these practical courses on students' attitude towards biology.

4.4 Practical courses for teachers

The described laboratory courses (restriction analysis and *ccr5* detection) were used in courses for experienced teacher as a part of lifelong education. The teachers have the possibility to bring their students to the Faculty of Science, Charles University in Prague, to take part in the practical courses and they also can borrow the equipment and perform the practical course on their school. We are glad to see both possibilities are being used.

5. Summary

We show several practical courses from molecular biology and genetics which have all been tested with high school and university students. Some of them require laboratory equipment but some not. The possible influence on the attitude towards biology has been tested now.

6. Acknowledgements

This work was supported by grant GAUK 452313, Czech Republic.

7. References

- [1] Vohra CF, Changing trends in biology education. *Biol. Int.* 2000; s. 49
- [2] White Wolf Consulting, Důvody nezájmu žáků o přírodovědné a technické obory. 2009. http://vzdelavani.unas.cz/duvody_nezajmu_obory.pdf [visited 26-March-2013]
- [3] Rocard M, Science education now: A renewed pedagogy for the future of Europe, European Commission, Directorate-General for Research, Science, Economy and Society,

Information and Communication Unit. Brussels: Office for Official Publications of the European Communities, 2007.

[4] Hofstein A, Lunetta VN. The laboratory in science education: Foundations for the twenty-first century. *Sci. Educ.* 2003; 88 (1): 28–54.

[5] Thompson J, Soyibo K. Effects of lecture, teacher demonstrations, discussion and practical work on 10th graders' attitudes to chemistry and understanding of electrolysis", *Res. Sci. Technol. Educ.* 2002; 20 (1): 25–37.

[6] Holstermann N, Grube D, Bögeholz S. Hands-on activities and their influence on students' interest. *Res. Sci. Educ.* 2010; 40 (5): 743–757.

[7] Ornstein A. The Frequency of Hands-On Experimentation and Student Attitudes toward Science: A Statistically Significant Relation. *J. Sci. Educ. Technol.* 2006; 15 (3): 285–297.

[8] Janštová V. Zastoupení různých disciplín biologie v praktických cvičeních na gymnáziích v ČR, 2013, presented on Študentské fórum, Velké Bílovice

[9] Balgopal M, Bondy C. Antigenic Shift and Drift. *Sci. Teach.* 2011; 78 (2): 42–46.

[10] Andrews TM, Price RM, Mead LS, McElhinny TL, Thanukos A, Perez KE, Herreid CF, Terry DR, Lemons PP. Biology undergraduates' misconceptions about genetic drift. *Cbe-Life Sci. Educ.* 2012; 11 (3): 248–259.

[11] Roth KJ, Druker SL, Garnier HE, Lemmens M, Chen C, Kawanaka T, Rasmussen D, Trubacova S, Warvi D, Okamoto Y. Teaching Science in Five Countries: Results From the TIMSS 1999 Video Study. Statistical Analysis Report. NCES 2006-011. *Natl. Cent. Educ.* 2006; pp 308.

[12] Marbach-Ad G, Rotbain Y, Stavy R. Using computer animation and illustration activities to improve high school students' achievement in molecular genetics. *J. Res. Sci. Teach.* 2008; 45 (3): 273–292.

[13] Marbach-Ad G. Attempting to break the code in student comprehension of genetic concepts. *J. Biol. Educ.* 2001; 35 (4): 183–189.

[14] Lewis J, Wood-Robinson C. Genes, chromosomes, cell division and inheritance - do students see any relationship? *Int. J. Sci. Educ.* 2000; 22 (2): 177–195.

[15] Falteisek L, Černý J, Vilímová V. Simplified technique to evaluate human CCR5 genetic polymorphism, *Am. Biol. Teach.* in press.

[16] Imperial S, Boronat A. Determination of the Rh Factor: A Practical Illustrating the Use of

the Polymerase Chain Reaction. *Biochem. Mol. Biol. Educ.* 2005; 33 (1): 50–53.

[17] Sezek F. Teaching cell division and genetics through jigsaw cooperative learning and individual learning. *Energy Educ. Sci. Technol. Part B-Soc. Educ. Stud.* 2012; 4 (3): 1323–1336.

[18] Furtado S. Painting life green: GFP. *Science in School.* 2009; 12: 19–23.

[19] Ondřej V, Dvořák P. Bioinformatics: A History of Evolution ‚In Silico‘. *J. Biol. Educ.* 2012; 46 (4): 252–259.

[20] Alozie NM, Grueber DJ, Dereski MO. Promoting 21st-Century Skills in the Science Classroom by Adapting Cookbook Lab Activities: The Case of DNA Extraction of Wheat Germ, *Am. Biol. Teach.* 2012; 74 (7): 485–489.

[21] Thomas JC. Characterization of the ‚CCR5‘ Chemokine Receptor Gene. *Biochem. Mol. Biol. Educ.* 2004; 32 (3): 191–195.

[22] Choe H, Farzan M, Sun Y, Sullivan N, Rollins B, Ponath PD, Wu LJ, Mackay CR, LaRosa G, Newman W, Gerard N, Gerard C, Sodroski J. The beta-chemokine receptors CCR3 and CCR5 facilitate infection by primary HIV-1 isolates. *Cell* 1996; 85 (7): 1135–1148.

[23] Samson M, Libert F, Doranz BJ, Rucker J, Liesnard C, Farber CM, Saragosti S, Lapoumeroulie C, Cognaux J, Forceille C, Muyldermans G, Verhofstede C, Burtonboy G, Georges M, Imai T, Rana S, Yi YJ, Smyth RJ, Collman RG, Doms RW, Vassart G, Parmentier M. Resistance to HIV-1 infection in Caucasian individuals bearing mutant alleles of the CCR-5 chemokine receptor gene, *Nature* 1996; 382 (6593): 722–725.

[24] Lucotte G, Mercier G. Distribution of the CCR5 gene 32-bp deletion in Europe. *J. Acquir. Immune Defic. Syndr. Hum. Retrovirol.* 1998; 19 (2): 174–177.

[25] Galvani AP, Slatkin M. Evaluating plague and smallpox as historical selective pressures for the CCR5-Delta 32 HIV-resistance allele. *Proc. Natl. Acad. Sci. U. S. A.* 2003; 100 (25): 15276–15279.

[26] Huetter G, Nowak D, Mossner M, Ganepola S, Muessig A, Allers K, Schneider T, Hofmann J, Kuecherer C, Blau O, Blau IW, Hofmann WK, Thiel E. Long-Term Control of HIV by CCR5 Delta32/Delta32 Stem-Cell Transplantation, *N. Engl. J. Med.* 2009; 360 (7): 692–698.



THE ROLES OF CARTOONS AND COMICS IN SCIENCE EDUCATION

Eva Trnova, Josef Trna, Vaclav Vacek
Masaryk University, Brno, Czech Republic
trnova@ped.muni.cz, trna@ped.muni.cz

Abstract. *The use of cartoons/comics is becoming more popular in science education. Their graphical form is suitable for the Net Generation which is well visually literate. Cartoons/comics are effective in supporting of understanding science. The use of cartoons/comics in science education could be a way of making science meaningful, relevant, and accessible to students and how to help in increasing of interest as well. We found that cartoons/comics may help to better understand the nature of experiments. Study presents advantages and disadvantages of using cartoons/comics, methods of using cartoons/comics in instruction and practical examples of cartoons/comics which impact on students.*

Keywords. Cartoons, comics, motivation, science education, using cartoons/comics.

1. Introduction

Science teachers have faced the problem how to promote students' interest, so they have looked for new methods and tools, which would not only interest students [23], but also lead to desirable educational outcomes. In context of the development of science and technology (especially ICT) the traditional position of the teacher as the only authority has been overcome and students' learning styles have varied considerably as well. The need to change educational methods has been proved by the findings of surveys carried out in the international PISA research, etc.

One of the possibilities, how to respond to the above mentioned facts, is to use cartoons/comics that are popular not only in entertainment, but also in edutainment. In recent decades, cartoons/comics have appeared in lessons worldwide. They are used to achieve different educational objectives; some of them are presented here including sources where you can find more information on how to use cartoons/comics:

- development of reading skills [2]
- enrichment of subject vocabulary [4]
- development of problem-solving skills [8]
- development of written expression skill [1]
- development of idea formulation skill [1]
- develop. of conflict resolution skills [18]
- identification of attitude to science [14]
- strengthening motivation [7]
- acquisition of scientific knowledge [6]
- detection and elimination of misconception ([11], [12], [13])

These issues should be included among research topics in science education.

2. Cartoons/comics and Net Generation

Popularity of cartoons/comics with the young generation is connected with their higher visual literacy, which is an essential characteristic feature of today's youth known as the Net Generation [20]. The way of expression based on means of visual communication and little text suits them perfectly. In connection with frequent use of ICT the Net generation can integrate images and text naturally. Members of the Net Generation are able to move between reality and virtual environments quickly. On the other hand, they have significant problems with reading long texts and their comprehension. That is why they find well-crafted cartoons/comics interesting and understandable. They do not like studying manuals and long instructions, because if a topic is not interesting for them, they skip passages and try to finish the text quickly [5]. It is therefore appropriate to use cartoons/comics for creation of manuals, etc.

Today's students are motivated by daily life issues set into a meaningful context. This requirement is accomplished when using cartoons/comics containing images with specific situations. Members of the Net Generation due to their lifestyle are always interconnected using different ICT and they prefer sharing information. Interactive cartoons/comics simulate this kind of communication. The Net generation considers their peers more credible than teachers when it comes to determining what is worth paying attention to [15]. Cartoons/comics can be used in situations when information is communicated by "image" peers. Students, having the habit of searching information they need in their private lives through ITC, refuse rote learning. They feel that everything can be found on the Internet, it is not necessary to remember facts. They refuse to read

long texts and prefer visual stimuli. These requirements are fully met in cartoons/comics that contain short messages set in meaningful contexts created by specific images. According to researches, students acquire abstract concepts better if they use cartoons/comics instead of conventional textbooks [9].

The Net Generation members express themselves easily through images. This can motivate active involvement of students in creation of cartoons/comics. This activity can lead to spontaneous acquisition of scientific knowledge and skills of scientific communication [16]. Students must study necessary information when creating texts inserted into "speech balloons" and they must formulate short meaningful and scientifically correct statements. Students' own work with cartoons/comics could help them improve their problem-solving tasks that require the application of new knowledge in unusual situations and problems of working with information. It is very difficult for some students to find necessary information in the text, evaluate critically, formulate their own opinions and draw right conclusions [19]. They often do not even know what information to find for a right task solution. The above mentioned problems are probably related to deficiencies in students' science thinking (science literacy). We can say that this is a core problem when students fail to solve tasks that require deeper understanding of subject concepts, principles and methods and they expect flexible application of knowledge acquired in different contexts [22]. They cannot do without professionally correct and reasonable argumentative skills even when processing texts based on daily issues. When creating cartoons/comics students connect quite naturally different situations of everyday life with scientific issues, learn to argue using professional terminology and create right ideas of discussed natural objects and phenomena.

3 Classifications of educational science cartoon/comics

A cartoon is a two-dimensional work of art that is not usually realistic or it is only partially realistic. Its purpose is usually caricature and humour used primarily for entertainment. Historically, cartoons evolved from a single image a "single-panel cartoon." This form has remained, especially as a satirical drawing in newspapers and magazines. Cartoons contain an image component and often a text component,

usually inscribed in a speech balloon that comes out of character's mouth. The text can also be written in a box inside the panel or under the panel frame. Combining two or more cartoons in a series, connected by the same idea or story, forms comics. The term comics came from the English word "comic-strip" which can be translated as a strip of comic images. An image is called a panel. Images, possibly with accompanying text, are organized one after another, creating a story. There are also comics without text. If the comic is short, which means it contains 2-5 panels arranged in a strip, it is called a strip.

Various types of cartoons/comics differ in many features and the main difference is their content. We are going to pay attention only to cartoons/comics with science content that are going to be referred to as science cartoons/comics (hereafter SCC). Many SCC can be used in science education, and they are referred to as educational SCC (hereafter ESCC). If we want to use ESCC in teaching systematically, they must be created intentionally. Several experts and companies in the world have already started creating ECCS. These authors of ESCC use different forms of representation, which leads to different use in teaching/learning. Let us outline some types of ESCC.

3.1 Educational science cartoons

The simplest ESCC are educational science cartoons, which take the form of a single panel. They do not differ from traditional illustrations much, but their characteristic features are satire, irony and humour. Their basic characteristic is the fact that the main information medium is an image and text may be absent or only accompanies this image. Figure 1 can serve as an example.

3.2 Sciotoons

P. K. Srivastava [21] also uses only one panel when creating "sciotoons", which has continuous text on one side, explaining depicted science issues simply and briefly. There is accompanying text under the picture, related to the situation shown (see Figure 2).

This kind of ESCC serves as motivation to study or as an incentive to stimulate discussion about the depicted issues. The combination of figurative representation and description of a

phenomenon usually leads to better understanding and remembering.



Figure 1. Educational science cartoon. Constellation.

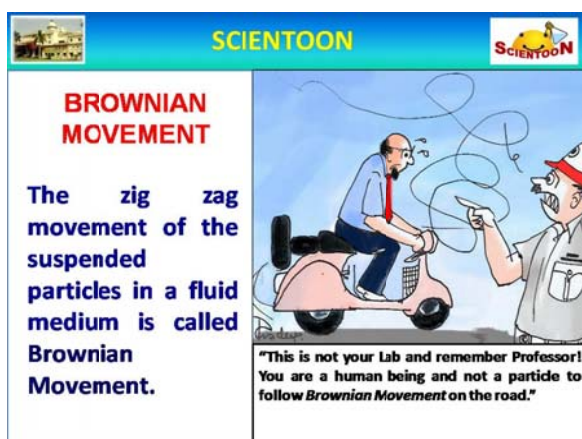

Figure 2. Scientoon. Brownian movement [21]

3.3 Concept cartoons

B. Keogh and S. Naylor ([11], [12], [13]) and their Millgate House Education publishing [17] produce and supply the educational market with "concept cartoons", which use one panel that contains mostly a group of characters discussing a certain issue. Individual characters suggest various problem solutions in their speech balloons. The authors specialize in overcoming misconceptions.

3.4 Comic strips

Several panels connected in a "comic strip" create a story that motivates students and brings them explanations of natural phenomena in a humorous form (see Figure 3).



Figure 3. Comic strip. Action-reaction [3]

4. Principles of creation of educational science cartoons/comics

Based on research using ESCC, ([13], [10]) formulated the following principles for the creation of ESCC, which we have modified as follows:

1. When creating ESCC a minimum of text should be used to make it clear and accessible to students of all ages and different levels of literacy.
2. Scientific knowledge should be used in connection with the issues of everyday life so that students can interlink phenomena and professional terms with events around them and can develop skills of professionally correct and reasonable argumentation.
3. ESCC should present alternative views on observed issues that could help to identify possible misunderstanding and should teach students how to distinguish between the alternatives.
4. ESCC should include all scientifically acceptable views on observed issues.
5. Presented alternative views on observed issues must be presented to students equally, so that students could not be affected by the form of presentation.

The use of ICT brings many new possibilities, including interactive ESCC, where it is possible to select answers and move interactively in the storyline. This form of ESCC is suitable also for informal science education. Today it is possible to create our own ESCC that would meet learning objectives and requirements of teachers and students fully. Previously, this option was suitable only for teachers with artistic skills. Nowadays, there are free programmes available

on the Internet for creation of your own ESCC. It is advisable to involve students in the creation of ESCC who can not only acquire scientific knowledge and skills, but also develop interdisciplinary relations, because students apply knowledge and skills from Czech language, Art, ICT and very often English language.

5. Benefits and risks of educational science cartoons/comics

ESCC similarly to any other teaching method has benefits and risks. A great benefit is considered a strong motivational incentive of ESCC, which may be weakened by excessive and improper implementation of ESCC in teaching/learning. It is also necessary to consider the content selection for ESCC creation carefully, because you cannot transform any topic into the ESCC form. The following Table 1 combines benefits and risks associated with the use of ESCC in science teaching/learning. Risks include measures how to minimize them.

Benefits	Risks
Great motivating potential	Excessive usage, inappropriate choice of content and inappropriate usage in lessons reduces motivational effects
Short concise texts suitable for the current Net generation that refuses to read long texts	Shortening and simplifying of texts may result in ambiguous and scientifically inaccurate statements. If students do not create ESCC themselves and are not forced to seek and process information, skills for working with text and reading literacy are not developed.
Putting subject matters into meaningful contexts	Fixation of a phenomenon and its solution in a given situation associated with the phenomenon in ESCC. Students can mismatch a particular situation shown in ESCC with the observed phenomenon or concept and they will not be able to match it with other conditions. Therefore, ESCC should include various alternative presentations of issues to
Visualization of issues - images representing issues to be solved	
Identifying and removing misconceptions	

	avoid misconceptions.
Interdisciplinary approach - using science knowledge and skills, mother language, art, ITC and very often English	Students can consider requirement for interdisciplinary skills an obstacle. However, it can be solved by appropriate guidance and help of the teacher and the choice of an adequate level of ESCC assignment.
A significant part of informal education, whether in the form of printed materials, or interactive materials on the website	Wrong processing of ESCC (text simplification leading to confusion and errors) without feedback of acquired outcome can lead to fixation of incorrect explanations and misconceptions.
Support of constructivist teaching approach - students acquire knowledge of natural phenomena based on gradual inquiry enabled by depicted situations, they do not accept only complete knowledge	Prevention is respecting principles of ESCC creation and presenting alternative views on issues, which can help to identify possible misunderstanding and teach students to distinguish between the alternatives. It is necessary to combine ESCC with other teaching methods and tools.

Table1. Benefits and risks of using ESCC

6. Conclusions

According to several surveys, ESCC are very popular with students. Their use in science teaching/learning does not mean solving all the problems currently faced by science teachers. It is another possibility how to increase students' interest in scientific issues and appropriate implementation in lessons can help to detect and correct some misconceptions, deepen understanding of natural phenomena and increase the competence of students in problem solving and communication. ESCC is a big issue and, in our opinion, not very well-known, so it should be included in the continuous professional development of science teachers.

7. Acknowledgements

The study was initiated within the project “PROFILES: Professional Reflection-Oriented Focus on Inquiry-based Learning and Education through Science“(FP7-SCIENCE-IN-SOCIETY-2010-1, 266589).

8. References

- [1] De Fren M. Using Cartoons to Develop Writing and Thinking Skills. *Social Studies Journal* 1988; 79: 221-224.
- [2] Demetrulias DAM. Gags, Giggles, Guffaws: Using Cartoons in the Classroom. *Journal of Reading* 1982; 26(1): 66-68.
- [3] Educational Comics; 2013. <http://www.kidsknowit.com/educational-comics/2007-02-12.php>
- [4] Goldstein B. Looking at Cartoons and Comics in a New Way. *Journal of Reading* 1986; 29(7): 657-661.
- [5] Grunwald P. Key Technology Trends: Excerpts from New Survey Research Findings, Exploring the Digital Generation, Educational Technology. Washington (USA): Department of Education; 2003.
- [6] Gutierrez R, Ogborn JA. Causal Framework for Analysing Alternative Conceptions. *International Journal of Science Education* 1992; 14:201-220.
- [7] Heintzmann W. Historical Cartoons: Opportunities to Motivate and Educate. *Journal of the Middle States Council for Social Studies* 1989; 11: 9-13.
- [8] Jones D. Problem Solving Through Cartoon Drawing. In: R. Fisher, editor. *Problem Solving in Primary Schools*. Oxford: Basil Blackwell; 1987.
- [9] Kabapinar F. Effectiveness of teaching via Concept Cartoons from the Point of View of Constructivist Approach. *Educational Sciences: Theory & Practice* 2005; 5(1): 101-146.
- [10] Keogh B, Naylor S. Concept Cartoons, Teaching and Learning in Science: An Evaluation. *International Journal of Science Education* 1999; 21(4): 431-46.
- [11] Keogh B, Naylor S. Starting Points for Science. Sandbach: Millgate House; 1997.
- [12] Keogh B, Naylor S. Teaching and Learning in Science using Concept Cartoons. *Primary Science Review* 1998; 51: 14-16.
- [13] Keogh B, Naylor S, Wilson C. Concept Cartoons: A New Perspective on Physics Education. *Physics Education* 1998; 33(4): 219-24.
- [14] Lock R. Creative Work in Biology-A Pot-pourri of Examples. Part 2: Drawing, Drama, Games and Models. *School Science Review* 1991; 72(261): 57-64.
- [15] Manuel K. Teaching Information Literacy to Generation Y. NY (USA): Haworth Press; 2002.
- [16] Millar R, Osborne J F. (Eds.). *Beyond 2000: Science education for the future*. London: King's College London; 1998.
- [17] Millgate House Education; 2013. <http://www.millgatehouse.co.uk/>
- [18] Naylor S, McMurdo A. *Supporting Science in Schools*. Timperley: Breakthrough Educational Publications; 1990.
- [19] NUV. *Prirodovedna gramotnost ve vyuce*. Praha; 2011. www.vuppraha.cz/wpcontent/uploads/2012/01/Prirodovedna_gramotnost
- [20] Oblinger D, Oblinger J. (2005). *Educating the Net Generation*. EDUCAUSE; 2005. <http://www.educause.edu/educatingthenet/en/>
- [21] Sciencetoon; 2013. <http://sciencetoon.com/>
- [22] Strakova J, Potuznikova E, Tomasek V. *Vedomosti dovednosti a postoje ceskych zaku v mezinarodnim srovnani*. In: P. Mateju, J. Strakova et al. (Ne)rovne sance na vzdelani. Praha: Academia; 2006.
- [23] Trna J. How to motivate science teachers to use science experiments. In: *ICSIT 2011. The 2th International Conference on Society and Information Technologies. Proceedings*. Orlando (USA): International Institute of Informatics and Systemics 2011; 142-144.



THE ROLES OF DEMONSTRATION EXPERIMENTS IN SCIENCE EDUCATION

Eva Trnova, Josef Trna, Petr Novak
Masaryk University, Brno, Czech Republic,
EU

trnova@ped.muni.cz, trna@ped.muni.cz

Abstract. *Not only student's experiments are very important for science education, but demonstration experiments have got an important role as well. Constructivist approach to teaching/learning science promotes students' experimentation because of more shares of*

student activity and inquiry. Thus does a demonstration experiment have a place in today's science teaching/learning? In our opinion, demonstration experiments belong to science education. Our study presents examples of appropriate methods of implementation of demonstration experiments in science education. The appropriate inclusion of the demonstration experiment in science education may help to better understand the nature of experiments and to increase required educational objectives.

Keywords. Constructivism, demonstration experiment, science education

1. Introduction

Experiments are one of the most important motivational factors in science education [18]. In spite of that, students' and demonstration experiments are underused in many countries (including the Czech Republic) [19]. The PISA survey 2006 [17] showed that the question "*whether teachers show students demonstration experiments*", was responded positively by only 19 % of respondents from the Czech Republic, while the OECD average was 34 % and the most positive responses (52 %) came from German respondents. In addition, 36 % of Czech students answered the question with "*never*" or "*almost never*". The situation is even worse with students' experiments, because the question "*whether students perform practical experiments in the lab*," was responded positively by only 9% of respondents from the Czech Republic, while the OECD average was 22 % and Danish students stated 61 %. A similar negative result of this research came with the question "*whether the teacher wants students to suggest how scientific questions could be examined in the laboratory*." This question was answered positively by only 10 % of respondents from the Czech Republic, the OECD average was 22 % and the most positive responses of 51 % were reported by respondents from Denmark.

Experiments have an irreplaceable role in science teaching/learning from the perspective of constructivist learning theory. It stresses the importance of students' experimentation, which is the basis of students' higher activity, and their active creation of knowledge and skill acquisition. Demonstration experiments conducted by teachers are in the background of interest and are not given adequate attention. It is essential to determine if a demonstration

experiment has its place in contemporary constructivist science education. It is necessary to analyze its advantages and disadvantages and modify the methodical application of a demonstration experiment in constructivist teaching/learning. Permanent significance of demonstration experiments has been indicated in studies showing that students remember interesting and appropriate demonstration experiments implemented in instruction more easily than students' experiments performed exactly as directed ([6],[7]).

2. History of school experimentation

First experiments were part of science teaching/learning at universities, already at the beginning of the nineteenth century. For example, the first laboratory instruction in chemistry in the UK was founded in 1807 by T. Thomson at the University of Edinburgh ([15], [16]). This approach was gradually reflected in teaching/learning at primary and secondary schools. It was considered necessary in England to allow students to perform students' experiments in the late 19th century. In 1899, experimentation was established as a basic requirement for teaching science at most schools in England [5]. At that time, hands-on activities played a crucial role in confirming theory.

The effectiveness of science education through practical students' activities was also doubted. That caused the first discussions about the relationship between students' and demonstration experiments. For example, a hundred years ago Armstrong spoke in favour of students' experimentation, which he preferred to demonstration experiments carried out by teachers [6]. However, students' experiments that were time consuming and expensive, were often mere routine activities performed exactly as directed and did not bring the expected results ([6], [7]). Therefore, in the 1930s in Britain, and similarly in the world, more attention was paid to demonstration experiments [7].

The discussion about the importance of students' and demonstration experimentation has continued. Today, a number of studies have dealt with the effectiveness of practical students' activities in relation to achieving educational goals [10]. The significance of demonstration experiments, their effectiveness and proper implementation in instruction have been discussed by a number of authors ([3], [12], [2], and [21]). They are no evident research results

demonstrating a clear relationship between students' experience of experimentation (especially in laboratories) and their learning ([7], [1], [4], [9], [8], and [14]).

3. Applications of students' and demonstration experimentation

We conducted empirical research of students' and demonstration experiments in science instruction. We used a video-study method. It is based on analysis of a video-recorded lesson. This method developed in the world in the 1990s in relation to TIMSS researches. The video-study we used was developed at university education centres in Germany (Kiel) and Switzerland (Zurich and Bern) and adjusted at our workplace [11]. We used video-recorded physics lessons taken at 12 lower secondary schools with students aged 13-14 and 13 physics teachers in 2004/5. 62 video-recorded lessons focused on the topics: composing forces (27 videos) and electrical circuit (35 videos). They included 119 (composition of forces) and 106 (electrical circuit) experiments. Frequency distribution of the experiments is shown in Figure 1.

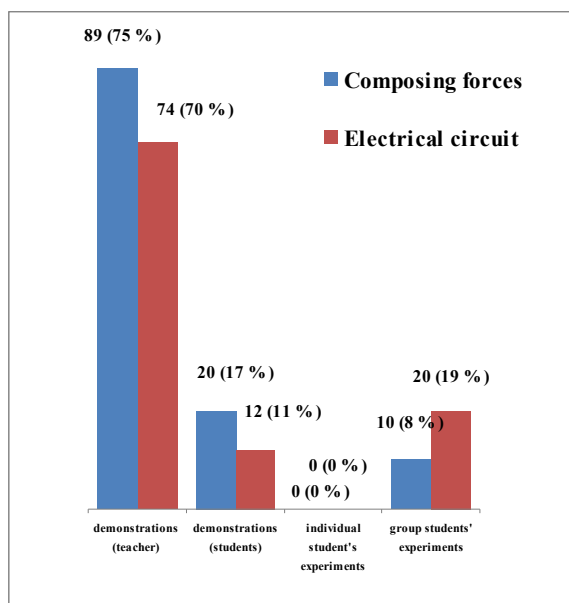

Figure 1. The frequency of demonstration and students' experiments in physics education

We have come to the conclusion in our research that the vast majority of presented experiments for both topics were experiments carried out by teachers (75 % and 70 %). What was positive was a relatively high proportion of demonstration experiments performed by students (17 % and 11

%). Teachers conducted students' experiments in groups of students (8 % and 19 %). Individual students' experiments were missing, as they were partly included in following individual laboratory works.

Our research and TIMSS research have shown that demonstration experiments predominate in science teaching at Czech schools. Through constructivist learning students' experiments are supported. This approach prefers students' activity which opens space for searching, inquiry and knowledge and skill acquisition. Experiments connect theory with practice and help students understand phenomena and laws. Teachers often fail to explain how the connection occurs and misbelieve that it occurs automatically during students' practical activities.

The reason why it is necessary to pay attention to not only students' but also demonstration experiments in research is a high proportion of demonstration experiments. Some authors [7] ask the question what students' activity is developed if they work according to precise instructions and passively fill in obtained data in prepared charts and relationships in worksheets. Such activity does not contribute to active knowledge, because sometimes students do not know what they do and why.

Each experiment, if properly planned and implemented, plays a vital role in understanding natural phenomena. It is necessary especially for younger students to integrate experiments into lessons because their thinking is closely connected with material activity and object handling. Students can understand relationships between phenomena better. They gradually acquire knowledge and its arrangement in the system. This method of learning does not create isolated concepts, for which it is very difficult to determine their essential characteristics, making it difficult for students to characterize, understand and classify them in the structure of acquired knowledge and skills. The best way how to achieve this is through students' own practical, explorative and experimental experience [13].

The result of our experience and design-based research is the conclusion that marginal demonstration experiments play an important role in constructivist teaching/learning. It is highly important for students to acquire essential skills under the guidance of teachers, skills they need for their own meaningful experimentation. These include the ability to observe consistently

and accurately, to use the apparatus correctly, to measure, build and test hypotheses of observed phenomena, to analyze results of experiments and draw conclusions. Students learn how to identify causes of natural processes, connections and relationships between them, to ask questions (How? Why? What happens if?) and to search for answers, to explain observed phenomena, to look for and solve cognitive or practical problems, to understand the importance of learning regularities of natural processes in order to predict or influence them.

Demonstration experiments have a completely irreplaceable role in the demonstration of dangerous phenomena and materials such as chemicals, fire, boiling water, electricity, etc. Many experiments are difficult to implement (Brownian motion, etc.), they last long (plant growth, etc.) or are economically difficult (expensive chemicals, etc.).

4. Advantages and disadvantages of demonstration experiments

We can find advantages and disadvantages of demonstration experiments in factor analysis. We have focused on some of them.

Demonstration experiments are performed by teachers individually or in cooperation with one or more students, in front of the whole class. The advantage is that all students have the opportunity to observe the experiment in progress intently and at the same time. Therefore, it is usually less expensive and time-consuming than students' experiments. The teacher can significantly affect students' attention focused on a particular part of the experiment, which could be disturbed by a strong, but less significant stimulus if performing students' experiments.

The biggest drawback of demonstration experiments is reduced activity of students and limited perception of experiment through more senses. According to the findings of C. Wieman, Nobel Laureate in Physics, passive observation of a demonstration experiment has educational effects similar to experiments not seen at all [20]. Therefore, students need to be activated for demonstration experiments.

5. Methods of implementation of demonstration experiments

Using design-based research, we have come to a few principles of implementation of

demonstration experiments in science teaching/learning.

5.1 Emphasis on the objective of demonstration experiments

Teachers must state a clear educational goal they want to achieve through a demonstration experiment. Regarding initial motivation, a surprising experiment is enough. If the educational goal is developing skills associated with experimentation such as designing experiments, setting up the experimental apparatus, predicting results, analyzing and presenting outcomes of the experiment and drawing conclusions, the teacher should define appropriate involvement of students in the implementation of demonstration experiments.

5.2 Controlled observation of demonstration experiments

When performing a demonstration experiment it is very important for the teacher to distinguish between mere perception (i.e. passive perception of stimuli from the environment) and observation (i.e. intentional and active perception of stimuli from the environment directly connected with mental activity) with respect to age and individual characteristics of students. When preparing a demonstration experiment the teacher must consider how to achieve the best students' controlled observation.

The major activities of the teacher include:

- (a) Determining the exact target of observation (students must know exactly what, how and why they are observing on experiment).
- (b) Teaching students how and what to observe, what to notice and in what order.
- (c) Establishing appropriate observation tasks (neither too easy nor too difficult - with respect to age and individual characteristics of students).
- (d) Connecting observation with comments, verbal description of the observed object or phenomenon.
- (e) Encouraging students to be consistent, independent and patient and to develop a set of needed students' communication skills.
- (f) Summarizing observations and drawing conclusions (the emphasis is put on essential characteristics).
- (g) Drawing students' attention (adequate duration of the experiment, stimulating students' attention with questions, etc.).
- (h) Making sure the experiment can be observed

by all students in the classroom. Controlled observation and comments on the ongoing experiment allow students to create right ideas about presented phenomena and object features. Compared with students' experiments the teacher can check more efficiently whether students draw right conclusions.

5.3 Development of students' thinking and creativity in demonstration experiment

Observation is of great importance for understanding objects, phenomena and their laws. Observation results are often an important starting point and foundation of students' knowledge and skills. Proper implementation of experiments can serve as a model for students to develop independent activity and creativity.

Students may participate in designing the experimental apparatus and in the procedure for the implementation of the demonstration experiment. What worked in practice was dividing students into groups, each of which suggested their own procedure for the experiment implementation. The teacher can control the discussion among groups, correct misconceptions and verify whether students know functions of equipment and instruments.

Another good activity is predicting the progress and outcomes of the experiment. First, students create and record their own opinions of how the experiment should develop and why. Then they consult their opinions with peers in the group. This leads to required confrontation of students' concepts. The teacher presenting individual groups can specify students' ideas, reveal any misconceptions and correct them. He/she can also add missing information. When performing experiments students confront their ideas with the real progress of the experiment. After it has been finished, students first discuss the results in groups. They compare their assumptions with reality. After that, each group presents their findings. The degree of teacher's involvement is given by the level of students' knowledge and skills. The teacher can monitor whether students know what has happened in the experiment and why, and check the level of educational outcomes.

At a low level of knowledge students can only be involved in anticipating the progress of the experiment and it is explained after the implementation by the teacher himself/herself. It is always advisable to let students express their opinion so that the teacher could reveal whether

they understand the presented phenomenon correctly. Such students' involvement corresponds with constructivist teaching/learning fully and minimizes differences between students' and demonstration experiments. According to research [10], students are motivated by such activities more than by laboratory works, which often limit activity.

6. Example of the implementation of the demonstration experiment

An example of suitable implementation of the demonstration experiment is preparation and collection of carbon dioxide CO_2 in different liquids when students verify its properties.

Carbon dioxide (instruction for the experiment): Set up 3 gas collection apparatuses using the picture below as a guideline. Pour into the separation funnel 20 cm³ of 10% hydrochloric acid HCl solution and put into the distilling flask 3 g of sodium carbonate Na_2CO_3 . The graduated cylinder filled to the brim with selected liquid (water or lime water or saturated solution of NaCl) shut with stopper, dip under the same liquid in the glass tub and after it open again. Slowly drop by drop add from the separation funnel HCl, which immediately reacts with Na_2CO_3 to give a colourless gas CO_2 that collects in the graduated cylinder. Observe and compare reactions in each apparatus and explain (see Figure 2).

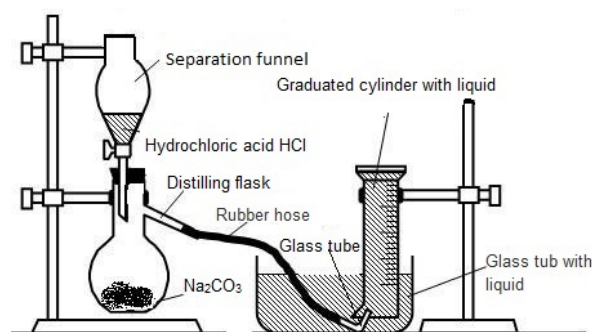

Figure 2. Preparation and collection of CO_2

6.1 Emphasis on the objective of the CO_2 demonstration experiment

The aim of this demonstration experiment is students' knowledge and skills:

(a) To come up with a chemical reaction that can be used for preparation of CO_2 and to write it down in the form of chemical equations.

The following chemical reaction was suggested

for the presented demonstration experiment:
 $\text{Na}_2\text{CO}_3 + 2 \text{HCl} \rightarrow 2 \text{NaCl} + \text{CO}_2 + \text{H}_2\text{O}$

(b) To suggest how to prepare CO_2 using substances that are common at home.

One possibility is the reaction of sodium bicarbonate and vinegar.

(c) To predict and justify the progress of chemical reactions based on the knowledge of CO_2 properties.

Students predict the reactions in individual apparatuses and justify their suggestions based on CO_2 properties, which is soluble in water and it is acidic oxide. Therefore, the reactions occurring in the individual apparatuses, where CO_2 is collected in different liquids, are different.

6.2 Controlled observation of the CO_2 demonstration experiment

The teacher shows students three different liquids: water, calcium hydroxide or lime water and saturated solution of sodium chloride into which carbon dioxide will be implemented. The teacher makes students watch the change of the colour, coagulation and changes in the volume of liquids in graduated cylinders during the course of the reactions. Such controlled observation makes students understand the differences between the reactions.

6.3 Development of students' thinking and creativity in the CO_2 demonstration experiment

Students had the opportunity to participate in the preparation of CO_2 , they did not follow passively what chemical compounds the teacher used and they could influence the choice actively. The course of reactions was observed with more interest, because students wanted to verify the accuracy of their predictions about the course of the reactions. The teacher presents the demonstration experiment and comments on the course of the reactions, highlights significant moments (or can let students comment).

The teacher's comment during the experiment: - *If water has been used, CO_2 dissolves in water partially, but the remaining CO_2 extrudes water from the cylinder and accumulates in it. The volume of the liquid in the cylinder is reduced.- If lime water has been used, it reacts with CO_2 to form milky colour caused by insoluble CaCO_3 . Carbon dioxide reacts with $\text{Ca}(\text{OH})_2$ in the*

cylinder and the glass tub and extrudes it. The volume of the liquid in the cylinder remains unchanged (or changes very little). Mixing pure carbon dioxide with lime water makes the lime water milky white in moments. This chemical reaction (sometimes called lime water test) is used to detect the presence of CO_2 .

- *In case of saturated solution of NaCl all the liquid is extruded from the cylinder because CO_2 does not react with NaCl solution and it is not soluble in it. If students can calculate the amount of produced CO_2 , they can verify whether the volume produced during the reaction corresponds to reality and compare with the alternative when CO_2 was collected into water.*

Students compare their assumptions with the actual course of the reaction and the correct explanation of the reaction. During this confrontation, the students understand the relationship between theoretical knowledge about CO_2 and practical experience. Students can repeat individual reactions as their students' experiments and they will know what they are doing and why in experimentation.

7. Conclusions

Demonstration experiments are considered classical but also modern ways of science teaching/learning. Their effectiveness is sometimes unfairly questioned in the context of constructivist learning approach. As our researches and experience have proved the demonstration experiment, when suitably implemented and activating students, is a very good way to develop students' knowledge, skills and interests.

8. Acknowledgements

The study was initiated within the project "Quality of Curriculum and Instruction across School Subjects", the Czech Science Foundation, GAP407/11/0262.

9. References

- [1] Blosser P. A critical review of the role of the laboratory in science teaching. Columbus OH: Center for Science and Mathematics Education; 1980.
- [2] Bodner GM. Why lecture demonstrations are 'exocharmic' for both students and their instructors. University Chemistry Education 2001; 5: 31–35.

- [3] Bowen CW, Phelps AJ. Demonstration-based cooperative testing in general chemistry: A broader assessment-of-learning technique. *Journal of Chemical Education* 1997; 74: 715-719.
- [4] Bryce TKG, Robertson IJ. What can they do? A review of practical assessment in science. *Studies in Science Education* 1985; 12: 1-24.
- [5] Gee B, Clackson SG. The origin of practical work in the English School science curriculum. *School Science Review* 1992; 73: 79-83.
- [6] dson D. A Critical Look at Practical Work in School Science. *School Science Review* 1990; 70(256): 33-40.
- [7] Hodson D. Re-thinking old ways: towards a more critical approach to practical work in school science. *Studies in Science Education* 1993; 22: 85-142.
- [8] Hofstein A, Lunetta V N. The laboratory in science education: Foundations for the twenty-first century. *Science Education* 2004; 88: 25-54.
- [9] Hofstein A, LunettaVN. The role of the laboratory in science teaching: Neglected aspects of research. *Review of Educational Research* 1982; 52: 201-217.
- [10] Hofstein A, Mamlok-Naanam R. The laboratory in science education: The state of the art. *Chemistry Education Research and Practice* 2007; 8: 105-107.
- [11] Janik T, Mikova M. Videostudie. Brno: Paido; 2006.
- [12] Johnstone AH, Al-Shuaili A. Learning in the laboratory: Some thoughts from the literature. *University Chemistry Education* 2001; 5: 42-51.
- [13] Kekule M, Zak V. Preference temat a vyučovacích metod ve fyzice z hlediska genderu. In: *Svet výchovy a vzdělávání v reflexi současného pedagogického výzkumu*. 2007; Ceske Budejovice.
- [14] Larazarowitz R, Tamir P. Research on using laboratory instruction in science. In: D. L. Gabel DL, editor. *Handbook of research on science teaching*. New York: Macmillan; 1994; 94-130.
- [15] Morrel JB. Practical chemistry at the University of Edinburgh, 1799-1843. *AMBIX* 1969; 26: 66-80.
- [16] Morrel JB. The chemistry breeders, the research schools? of Liebig and Thomas Thomson. *AMBIX* 1972; 19: 1-47.
- [17] Paleckova J. et al. Hlavní zjištění PISA 2006: Poradi si zaci s prirodniimi vedami? Praha: UIV; 2007.
- [18] Trna J, Trnova E. Cognitive Motivation in Science Teacher Training. In: *Science and Technology Education for a Diverse World*. Lublin (Poland): M. Curie-Sklodovska university press; 2006; 491-498.
- [19] Vaculova I, Trna J, Janik T. Ucebni ulohy ve vyuce fyziky na 2. stupni zakladni skoly: vybrane vysledky CPV videostudie fyziky. *Pedagogická orientace* 2008; 18(4): 59-79.
- [20] Wieman CE, Perkins KK, Adams WK. Oersted Medal Lecture 2007: Interactive simulations for teaching physics: What works, what doesn't, and why. *American Journal of Physics* 2008; 76: 393.
- [21] Zimrot R, Ashkenazi G. Interactive lecture demonstrations: A tool for exploring and enhancing conceptual change. *Chemistry Education Research and Practice* 2007; 8: 197-211.



SCIENCE TOYS AND INTERACTIVE EXHIBITS IN CHEMISTRY TEACHERS' EDUCATION

Ján Reguli

*Department of Chemistry, Faculty of
Education, Trnava University, Trnava,
Slovakia
jreguli@truni.sk*

Abstract. *Interactive exhibits and science toys are the basic means of hands-on science education. They can readily be applied at science lessons at primary and secondary schools and this way they make the lessons attractive and enjoyable for children. Therefore we use science toys and simple interactive exhibits in various subjects in chemistry teachers' education. Our students are trained to create their own scientific toys. This presentation shows some of the interactive teaching tools used at lessons of Physics for Chemists, Physical Chemistry and Science Communication as well as some of the scientific toys our students have constructed and applied in their lessons.*

Keywords. Scientific toys, science teachers' education, physical chemistry, science communication

1. Introduction

The 1980s are associated with creation and opening of many science centres in Europe. Wikipedia defines Science centre as “*a science museum that emphasizes a hands-on approach, featuring interactive exhibits that encourage visitors to experiment and explore.*” (http://en.wikipedia.org/wiki/Science_center). *Hands-on approach* means “learning by doing” or “school by play”. Small interactive exhibits can be found in science shops as *science* or *scientific toys*.

2. Which toys are scientific?

Science toys or scientific toys can be defined as toys or games, for playing or manipulation with which you need logical reasoning. Such toys include various jigsaw puzzles or brain teasers. Recent discussion games DeMOCs involved in the PlayDecide project can be considered as scientific games.

In more precise meaning science toys are things (intended for playing, or with which you can play) manipulation with which demonstrates various physical principles, or which use various physical or physico-chemical properties of the material, which they are made of/from. E. g., toys that change colour with temperature change or mechanical toys that use unusual position of the centre of gravity. Other toys use non-mixable liquids, liquids with high viscosity, or “magnetic liquids”. Typical scientific toy is the glass bird (filled with volatile methylene chloride) apparently forever drinking from a cup with water or the well-known Cartesian diver.

The common quality of scientific toys is the motivation for inquiry – stimulation of curiosity, asking questions, and searching for answers to questions. Questions like these: Why does the toy work this way? Which properties of the toy determine its typical behaviour? Using a toy at school lessons offers further questions: Which physical principles are applied during the play? Which physical properties are characteristic for the toy? Manipulation (playing) with the toy leads to further questions: Does the toy behave always the same way? How do external conditions influence this behaviour? Can we predict the behaviour of the toy another time? [1]

3. Scientific toys in *Physics for Chemists*

Future chemistry teachers meet the interactive teaching tools for the first time at seminars of *Physics for Chemists*.

Physics for Chemists (beside repetition of some basic physical topics (mechanics, electricity)) is devoted to those parts of physics that deal with physical properties of substances, especially in liquid phase.

Other parts deal with electromagnetic radiation and with optical properties – absorption and refraction of light, polarisation of light and optical activity of chiral compounds.

3.1 Mechanical properties of liquids



Since buoyancy is one of the most characteristic properties of liquids, the first scientific toy introduced to our students is the *Cartesian diver* prepared in various ways and sizes. Other toy that demonstrates the relation of gravitation and buoyancy is made of four test tubes, filled with four different solutions of ethanol and water. The

test tubes also contain polyethylene granules of three colours. Densities of the granules and of the solutions closely vary around 0.94 g cm^{-3} . Therefore after turning the tubes upside – down the granules move and divide according to relation of their density (increasing in the order black \rightarrow yellow \rightarrow green) and density of the solutions. In the first test tube all granules are lighter, in the second only two colours go upwards, in the third only the black granules remain on the top, and in the fourth test tube all granule have higher density than the solution and so they fall down

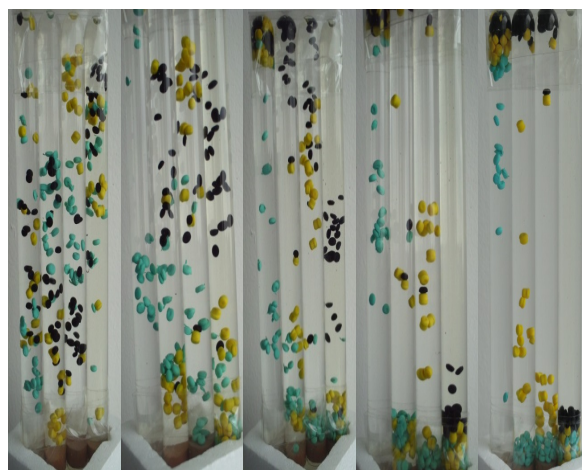

Another important physical property of liquids is viscosity, caused by internal friction. Three different forces influence a ball falling in a liquid: gravitation, buoyancy and internal friction. The difference between gravitational force and buoyancy makes the ball to move. The third – frictional Stokes force – increases with increasing velocity. In a short time the sum of the forces equals zero. Since then the ball moves with constant velocity (uniform motion). This result holds both for heavy steel balls and for light air bubbles. (Air bubbles are spherical due to surface tension.) We demonstrate this phenomenon in test tubes filled with viscous oil

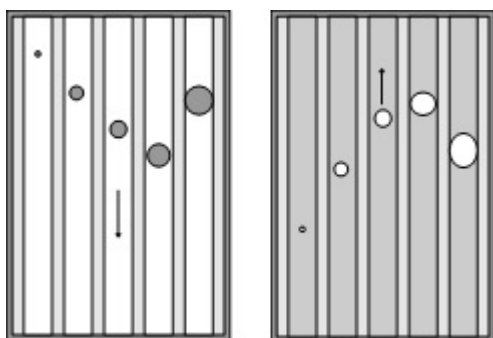

(the movement of the liquid must remain laminar). In a toy with four test tubes we can demonstrate, that the velocity of the moving particle is proportional to its size ($v \approx r^2$) and therefore bigger balls (or bigger bubbles) move faster (except the biggest one that is slowed by the wall of the tube).

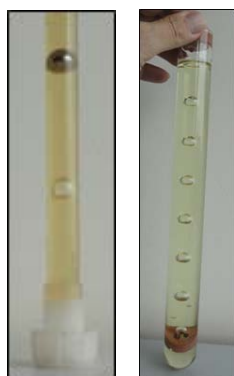

My favourite science toy remains the “bubble machine” that makes uniform air bubbles that move in the test tube through the oil upwards with constant velocity.

3.2 Optical properties of liquids

Liquids are mostly transparent, so they provide good medium for demonstration of various optical properties. The first of them we mention is the absorption of light. There are many well-known science toys presenting additive or subtractive mixing of colours (three torches with red – green – blue colour light, small flywheels with three colours). Very useful instrument helping to explain the colour of things is the small school spectrometer

V-SPEC that enables to see that the blue vitriol (CuSO_4) is blue because it absorbs red light or that phenolphthalein is pink due to its absorption peak in green region of spectrum.

If you have a colourless transparent object, you can't see it if it doesn't refract light. So if you put a glass thing (a flask or a rod) in a liquid with the same refractive index, you will not see it. The viscous glycerol is often used for this purpose. Another liquid with the proper refractive index (approximately 1.47) can be prepared of toluene with a small amount of ethanol.

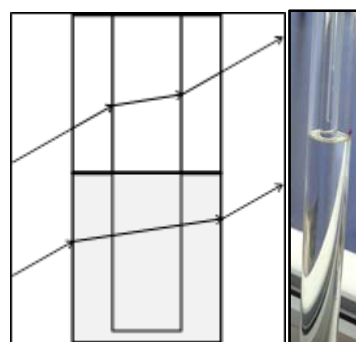

A test tube filled with water can serve as a nice science toy as it magnifies the view only in one dimension.

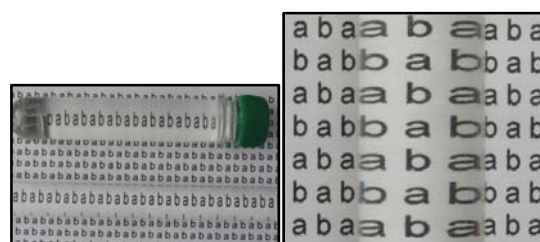

When we turn this test tube with water approximately 30 cm before a sheet, we shall see the image in the test tube turning with double velocity:



If we turn the paper, the image in the test tube turns in the opposite direction.

A distillation flask and a glass aquarium enable you to show that one object can serve both as magnifying (if you pour water in the flask) and a reducing lens (if you insert empty flask in the aquarium with water).

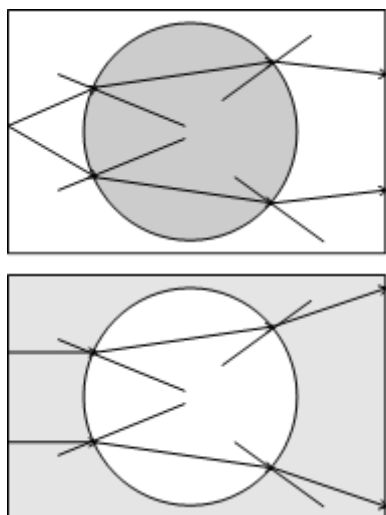

Polarisation of light is one of its properties that we meet daily. We use LCD in all our digital equipment. Thanks to thin foils that polarise light we use glasses with polarisation filters to protect our eyes from the reflected light (which is polarised too). Polarimeters serve to study of optically active compounds (compounds that turn the polarisation plane to the right or left side).

Thanks to thin polarisation foils, we don't need nicol prisms to polarise light. We can demonstrate action of two and three polarisation filters. Polarisation foils make visible inner structure of many transparent objects since the angle of rotation depends on the wavelength of the light. (This phenomenon is called photoelasticity).

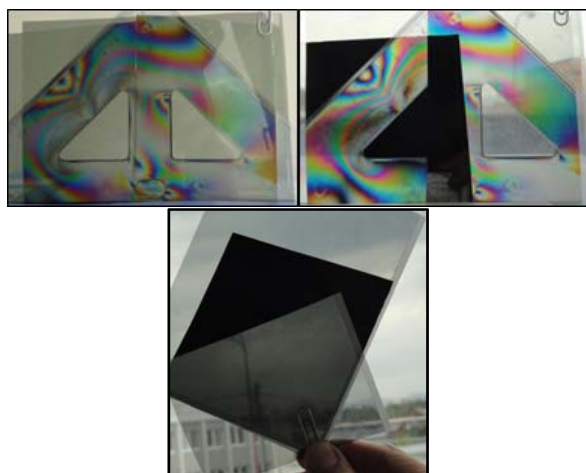

Two perpendicularly oriented polarisation foils don't let to pass any light through. If you insert between them a third foil, the light will pass through – and you will need knowledge of quantum mechanics to explain it.

4. A chemical scientific toy

Chemical equilibrium and Le Chatelier's Principle meet with many students' misconceptions. This principle says that "If a chemical system at equilibrium experiences a change in conditions (concentration, temperature, or pressure), then the equilibrium shifts to counteract the imposed change and a new equilibrium is established".



Solutions of cobalt chloride in ethanol – water mixtures enable to prepare simple tools that help to explain Le Chatelier's Principle. The solution of CoCl_2 in water is pink, but in ethanol it is blue. We can describe the equilibrium system by this

equation:

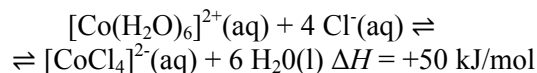

Pink solution \rightleftharpoons Blue solution

The forward reaction is endothermic, thus heating will change the pink solution to blue. This system is often used to demonstrate influence of heat and concentration on the composition of reaction mixture at chemical equilibrium.

It is possible to prepare CoCl_2 solutions with different proportion of water and ethanol into test tubes. This way we get systems in which the colour change occurs at different temperatures. When we put such test tube with blue solution into a bath with cold water, the solution in the cold bottom part of the test tube will turn pink. Heating pink solution with higher water content will turn it blue (then the lighter warm blue solution will rise up in the test tube).



4. Scientific toys prepared by future chemistry teachers

Science communication is a subject involved in undergraduate chemistry teachers' education. Science, relation of science and society, scientific and technological literacy of the public, formal and non-formal science education, importance and methods of mutual communication of scientists with the public, institutions of non-formal science education, interactive science exhibitions, and creation of science toys are the main topics of science communication. The last task for the students is to create a scientific toy. In recent years our students (for the lessons of science communication and during realisation of diploma thesis) have prepared and demonstrated various toys, including kaleidoscope, periscope, spectroscope [2], man powered electrical engine, or inclined plane for a playful study of friction of variopus materials on various surfaces[3].

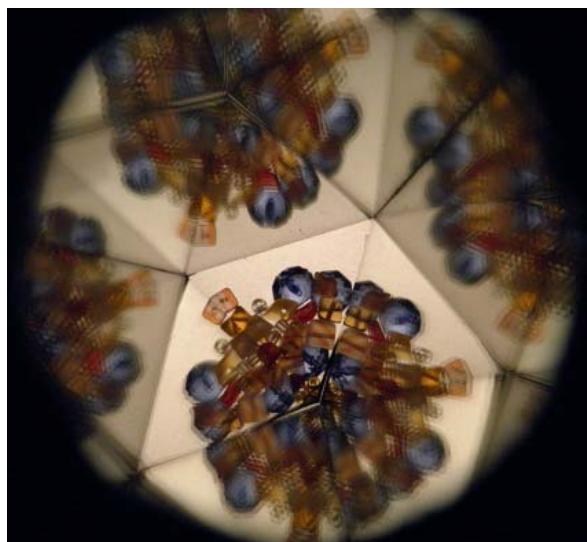

5. Acknowledgements

This contribution has been prepared with support of the KEGA project 004TTU-4/2013 *Creation*

of educational materials for undergraduate and life-long chemistry teachers' education and for students involved in Chemistry Olympiad.



6. References

- [1] Reguli J. *Non-formal Education in Chemistry*. Bratislava: Vydavateľstvo STU, 2001, 109 str. ISBN 80-227-1553-0.
- [2] Cepková L. *Attractive demonstrations of optical properties of substances*. Diploma thesis. Trnava: Faculty of Education TU, 2011. 112 pp.
- [3] Haluza M. *New materials and technologies in science and technology education – tribology and its use in educational projects*. Diploma thesis. Trnava: Faculty of Education TU, 2011. 73 pp.



TEACHER PREPARATION FOR INQUIRY BASED BIOLOGY EDUCATION AT P. J. ŠAFÁRIK UNIVERSITY

Katarína Kimáková, Andrea Lešková

*Pavol J. Šafárik University in Košice,
Faculty of Science,*

*Institute of Biology and Ecology, Mánesova
Košice*

katarina.kimakova@upjs.sk

andrea.leskova@upjs.sk

Abstract. *Faculty of Science, P. J. Šafárik University in Košice is a partner of the 7th FP project ESTABLISH (European Science and Technology in Action: Building Links with Industry, Schools and Home). How to implement inquiry based science education at school is presented at the Institute of Biology and Ecology where courses for pre-service and in-service Biology teachers take place. After 16 lessons of*

theoretical education and after practical application of this teaching-learning method in classes, teachers present their own ideas of inquiry based teaching activities.

In this paper we present some of the ideas and examples of challenging questions, which can be even tasks for students to find answers by different levels of inquiry. They can carry out short exploration at school or produce an output in the form of a complete project. Pre- and post-test were administered before and after the course. Our aim was to map the views of the teachers on active inquiry as a learning method for biology. The result does not justify statistically acceptable conclusions yet, since the courses completed only a small number of selected future teachers (36) and in-service teachers (24). We provide here just some examples of the responses, which show that this view is slowly changing under the influence of experience and education.

Keywords. Biology. Inquiry based science education. Teacher preparation.

1. Introduction

In recent times, the European Union has devoted efforts and considerable resources to support teaching and learning science. The reason for this problem is the decline in interest in the study of technical and scientific fields. PISA studies show that our pupils have acquired a large amount of theoretical knowledge. However, they cannot prove logical thinking and assessment of science phenomena, and to examine them at the appropriate mental level, generate hypotheses, find and propose solutions to interpret data. They have a problem with formulating arguments and conclusions.

Today, in the European area, there is a number of international projects aimed at the implementation of methods for learning natural science research and discovery. One of them is the 7th Framework Programme project ESTABLISH, (European Science and Technology in Action Building Links with Industry, Schools and Home). Within this project, new materials including methodic guide to teach physics, chemistry, biology and technology on inquiry basis are being prepared. Inquiry based teaching means changing the way of teaching science and transformation of thinking at schools in Europe. Support for activity based and experiential learning is

important for the development of creativity and problem-solving abilities. Deeper understanding of the natural sciences is more than a mere knowledge of facts it pursues the objective of developing critical thinking of students.

2. Inquiry based teaching

According to Linn et al. [2] inquiry is a purposeful process of formulating problems, critical experimentation, assessment of alternatives, investigation, verification, inferring information retrieval, modelling of processes, discussions with others and forming coherent arguments. It is a strategy model for teaching and educational process. In implementing the inquiry-oriented teaching, the teacher builds knowledge-system of pupils via questioning (talking-education), and through addressing a problem. The teacher leads the student to work similar to what is common in real research: to discover the problem, to formulate hypotheses, to found the methodology, to design procedure and obtain solutions. In this process, students are not only listening to the arguments of the teacher about how things work in the nature. They discuss, argue and formulate conclusions alone and actively acquire the necessary competencies, knowledge and communication skills. Bybee [1] states that inquiry is a teaching strategy as well as a model for educational practice.

When teaching, we can distinguish different degrees of scholarly activity, depending on the degree of involvement of the pupil or teacher as well as the degree of support for teaching materials. Wenning [3] distinguishes different grades of research:

Interactive demonstration - the teacher when manipulating with scientific instruments - put interactive questions such as "what happens", "how (why) something could happen". Answers and explanations are formulated by pupils alone.

Guided discovery - the role of the teacher is the same as for interactive demonstrations but pupils carry out the experiment. It is a traditional laboratory work that follows step by step instructions.

Guided inquiry - students work in teams on their own experiment. The teacher formulates a problem and gives the goal: "Find...," "Determine..." etc. The conclusions are based solely on the work of students. They get only a laboratory instruction and a set of guiding questions.

Bounded inquiry - is similar, but the students are

expected to design an experiment themselves. It takes place with minimally or no intervention of the teacher. The research problem is provided by the teacher. Students are responsible for the design and implementation of the experiment. It is usually necessary before the partial orientation in laboratory, where students have little experience.

Open inquiry - students are expected to find a problem, formulate their own research question within the context of the theme, and design an experiment to verify the hypothesis.

ESTABLISH project aims to facilitate innovations in classroom practice through the involvement of different inquiry level in the development of teaching and learning units. Created units - with appropriate support for both in-service and pre-service teachers - help to implement Inquiry Based Science Education (IBSE) in our country.

3. Method

Pre-service biology teachers completed a course focused on IBSE at the Faculty of Science at P.J. Šafárik University in Košice. This course was realized at master study level, in the fall semester within 16 hours. Students also participated at the teacher training practice at secondary level of school after this course. Sample size consisted of 36 pre-service teachers. Before we started the training, a pre-test had been administered, and after the teacher training practice, the future biology teachers completed a post-test questionnaire. The questionnaires were developed for the ESTABLISH project (Teacher Profiling 2012). The pre-test has 5 parts: Section A Background information, Section B My views of inquiry (7 questions), Section C Attitudes and views toward science and science teaching (21 questions), Section D Teaching science (7 questions), Section E Challenges (3 questions and it also contained some open ended questions. The post-test was the same, except Section C. Instead of attitudes towards science and science teaching it was mapping Industrial content knowledge (5 questions).

A very similar, but not the same ESTABLISH questionnaire was administered also for in-service teachers. In-service teachers completed an IBSE course within 12 hours. The sample size consisted of 24 teachers.

Because only a little number of future biology teachers and in-service teachers completed the courses at this time, it is not possible to make

statistically acceptable conclusions yet. We evaluated the proportion of concordant and discordant responses of students on items in the pre- and post-test. Replies to reverse-worded questions were encoded that higher values reflect IBSE favourable responses.

Responses in Section E were scored in a manner that the factor identified by teacher first in the order received 3 points, second in the order received 2 points, and the third 1 point.

4. Results

Pre-service and in-service teachers were given the task to develop an IBSE activity on the end of the course according to their own ideas. The condition was only that the idea can be used for teaching of 12-18 old pupils, and respecting the Slovak biology state curriculum. After 12 hours education in which trainees were familiar with IBSE, and examples of activities developed for the ESTABLISH units were tested, they were able to generate a relevant idea for teaching and learning by inquiry. About a third of them were not able to formulate their own idea according IBSE criteria, and clearly explain for other teachers how to implement the idea. Approximately two-thirds of pre-service and in-service teachers needed guidance, and modify their proposals in accordance with philosophy of IBSE. They find it difficult to provide students with their own space in order to find answers and solutions to problems alone, to research the problem and also to motivate student's exploration. Pre-service teachers have not had enough experience in their own practice therefore they not want to deviate much from the method of teaching experienced by them at school.

Although selected ESTABLISH activities were experienced by trainees at a course in the role of students, they do not believed that pupils and students can be kept under control during independent inquiry, and that their pupils can manage such activities. Their ideas often remained at the level of interactive demonstration and guided discovery. Experienced in-service teachers who had the opportunity during the course to try IBSE at the classroom with their students, can point their ideas closer to guided, bounded and open inquiry. For IBSE, it is important, what kind of questions is the teacher asking, when his/her goal is to motivate the inquiry.

We provide a few examples of graduates'

question ideas, which were later completed as IBSE activities.

Pre-service teachers:

1. Try to design a tool for visually impaired and blind people, enabling them to write on the touch screen. Consider using touch screens (phones, tablets) and the use of Braille.
2. John noticed that if he measures his height in the morning, it is a little more than in the evening. He does not know why, therefore, explain what might cause such a difference. Can you help him?
3. Danka and Michael can not solve a problem. Danka argues that the eyesight of humans as highly organized mammals is in many ways better than the vision of the small insects. Conversely, Michael is convinced that just insects have improved eyesight. Which one is right?
4. Find arguments and relevant information: The human figure is slightly reduced throughout life - older people are lower than they were in their youth. Why is that?
5. Pupils will observe their pets for one week. Their task will be to identify and write down:
 - At what time does their pet get up / sleep?
 - What kind of food does their pet like more and which less? - What does the pet do all day?
 - How does it behave in the company of people?

In-service teachers:

1. Joe has a trouble because in the corner of his bedroom he discovered a big dark grey stain. He has no idea what it could be. The only information he knows is that it may be some fungus. How could he find out? What would you advise him?
2. Take a tuning fork and vibrate it just a little. You do not hear the sound. Touch your jaw with the tuning fork and you hear the sound inside of your head. How is this possible? Why do we hear? Explain.
3. Attach a transparent plastic bag on a branch with leaves and a twig stripped of leaves. We soon observe that water is condensed in the bag where the leaves were intact, and where the leaves were

removed, pocket remained dry. What could be causing the difference? Suggest how to verify your assumption.

Pre-and post-test is used within the project ESTABLISH for determining teacher's views of inquiry, of challenges in teaching inquiry, attitudes towards science and science teaching. This test has not been yet administered by sufficient number of respondents in Slovakia to draw any statistically significant conclusions. We have found a shift in the views of the future biology teachers by a simple comparison of the responses to the same questions in the pre and post-tests.

Pre-service teachers generally think they understand the role of a teacher and a student in IBSE. They understand what inquiry teaching means. This belief was strengthened after the course. Only one student said that he/she does not understand.

Most of the teachers think that inquiry takes too much time but it is appropriate to achieve the objectives of the education. This attitude did not change even after the course.

Only 9 of 36 pre-service teachers thought that inquiry is only suitable for talented students and only two reported that inquiry will never become their method of teaching. In assessing barriers to the implementation of IBSE, future teachers saw generally difficulties according to severity in the following order:

1. Lack of equipment/assistance in school laboratories
2. Lack of time to implement inquiry
3. Lack of supportive school management
4. Curriculum constraints
5. Limited scientific content knowledge to use inquiry effectively
6. Limited knowledge of teaching by inquiry
7. Assessment methods for inquiry
8. Classroom management issues
9. Limited knowledge of ICT as used in inquiry (Fig 1)

In the post-test compared to pre-test, biology teachers attribute less importance to lack of facilities / equipment in the school laboratory, little time to inquiry and curricular limitation. Conversely, as a most important factor in post-test they reported lack of support from school management, limited knowledge of the subject as well as efficient management of inquiry and limited knowledge of the learning method based

on exploration.

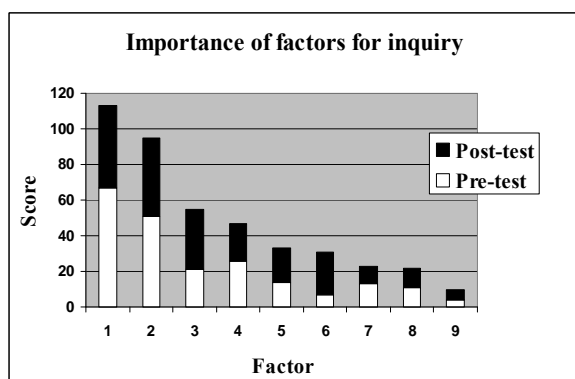

Figure 1. Difficulties when implementing IBSE – teacher education, pre-test and post-test score

5. Conclusions

The significant outcomes of pre-service and in-service teacher education focused on IBSE were that:

- Teachers who were engaged in this programme were able to develop their own IBSE materials at the end of the course, from a starting point of inexperience (similar to that of students, future biology teachers).
- The materials developed by teachers were shared amongst other participants and so this collection was growing.
- Teachers naturally formed peer-supportive clusters around particular scientific topics.
- Pre- and in-service teachers reconsidered their view of what is the biggest obstacle to the implementation of IBSE.

6. Acknowledgements

This work was supported by 7th FP project ESTABLISH. We acknowledge our colleagues, ESTABLISH partners, especially Swedish, who assembled the IBSE teacher education programme.

7. References

- [1] Bybee RV. Scientific Inquiry and Science Teaching: In Flick LB, Lederman NG. (ed.) Science Inquiry and Nature of Science. Implications for Teaching, Learning, and Teacher Education. Dordrecht,

Netherlands: Kluwer Academic Publisher, 2004, pp. 1–14.

- [2] Linn MC, Davis EA, Bell, P. Internet Environments for Science Education. Mahwah, NJ, USA: Lawrence Erlbaum, 2004
- [3] Wenning CJ. Levels of Inquiry: Hierarchy of Pedagogical Practices and Inquiry Processes, Journal of Physics Teacher Education Online, 2(3) 2005, 3-11
- [4] Pre-service Teacher Questionnaire, ESTABLISH (244749) © March 2012



A BIOINORGANIC COORDINATION CHEMISTRY INTEGRATIVE EXPERIMENTAL APPROACH: REVERSIBILITY OF THE ACID HYDROLYSIS OF A CR-S BOND

Teresa M. Santos, Júlio Pedrosa de Jesus
Chemistry Department and CICECO,
University of Aveiro, Portugal
teresa@ua.pt

Abstract. Bioinorganic is nowadays one of the main targets of Inorganic Chemistry Research. A single laboratory work comprising both areas, followed by discussion, can give students a wide vision of the chemical global world of today. Beginning by the analysis of the biological double role of chromium, an essential or carcinogenic element (oxidation states +3 or +6), the study of $\text{Na}[\text{Cr}^{\text{III}}(\text{L-Cys})_2]$ as a model for the intracellular formed Cr(III) species after Cr(VI) cellular entrance and reduction, and its Cr-S bond opening and closing behaviour under a narrow pH window (5.0-7.5), mimicking biological fluids, easily conducts students to considerations about chromium biological mechanisms.

This experiment/discussion is expected to successful fill a hole in Secondary School or 1st University Year Laboratorial work, because combines different science disciplines.

Keywords. Bioinorganic, chemistry-biology integrative laboratory experiment, chromium, complexes, reversible Cr-S acid hydrolysis.

1. Introduction

1.1. Pedagogical framework

A large and growing segment of students continue to seek for biological sciences, in the final years of high school and lower undergraduate degrees at university (first studying cycles of Bologna Degrees). With the ever-increasing emphasis on molecular phenomena in biology the necessity of solid foundations in chemistry has become well established. Nevertheless, most introductory chemistry courses devote relatively little attention to biological applications of this discipline. Similarly, the chemistry included in many biology courses and texts is fragmentary and superficial [1].

Many strategies to develop new curricula in order to promote inter-disciplinarity and fulfill this objective have been made and put into the teaching field.

For many years “integration” has been a part of the language describing various educational enhancements in chemistry and biology. The scope of integration spans the purposeful inclusion of chemistry and biology and one of their main targets has been single laboratory experiments. Other approaches to integration include the offering of inter-disciplinary research projects to 1st and 2nd year students. But cross-disciplinary teaching is something that neither chemists nor biologists can do alone, which is perhaps the most difficult aspect of improving undergraduate education in the sciences [2].

Some few paradigmatic examples involving both sides contents can be cited, as for example those referred here which have been chosen, or just picked up, from The Journal of the Chemical Education [1-5]. Some of these studies show clearly the extra benefits for the students who have fulfilled “mixed” disciplines, or even only have attained inter-disciplinary practical laboratory classes, that is, an added-value of the interdisciplinarity [4,6].

All the literature examples under this subject demonstrate that the promotion of inter-disciplinarity is connected with the nature and the expansion of the learning outcomes of the student responses and mainly to laboratory experiences. Students had a broader view of inter-disciplinary science after finishing the new sequence compared to their counterparts in the traditional chemistry or biology sequence, helping to strengthen ties between chemistry and

biology disciplines.

1.2. Scientific framework

Cr(VI) is a known mutagen and carcinogen that crosses cell membranes readily through the transport channels of structurally similar anions, that is, sulfate and phosphate. Once inside the cell Cr(VI) is reduced, and although the nature of some of the resulting chemical species is well known some others are still poorly characterized. It is believed, for example, that certain Cr(V) compounds may also be very important intermediates in this reduction process. In any case, the *in vivo* intracellular reduction reactions of Cr(VI) produces Cr(III) complexes with amino-acids (in particular, L-cysteine given to its high intracellular concentration) or with peptides and proteins or cysteine residues (glutathione, GSH, a tri-peptide with L-cysteine, for example), which are involved in the mechanisms of toxicity of chromium. The nature of the ligand that coordinates to Cr(III) appears to strongly influence the biological action of these compounds. Ligands with S atoms, such as L-cysteine and glutathione are particularly important, since they readily reduce Cr(VI).

The induction of the genotoxicity by Cr(VI) is dependent on its reductive activation inside the cell. It was found that reduction of Cr(VI) by L-cysteine resulted in the formation of mutagenic Cr(III)-DNA adducts in the absence of oxidative damage. Cr(III)-dependent types of DNA damage under a broader range of Cr(VI) and L-cysteine concentrations have been investigated. The obtained results further establish Cr(III)-DNA adducts as the major forms of DNA damage resulting from Cr(VI) metabolism by L-cysteine. The role of this amino-acid becomes more significant under occupational exposure conditions to Cr(VI)-containing welding fumes, for example [7].

When chromium is studied in solution some interesting aspects are involved: oxidation-reduction and acid hydrolysis reactions. In terms of redox reactions the reducing capacity of sulfur-containing species and their further binding to the metal centre is particularly relevant, due to the yielding of Cr(III) coordination compounds with Cr-S bonds. These characteristics are important to allow a better elucidation of the biological behaviour of this element [8].

One of the aims of Bioinorganic Chemistry research is the synthesis of good models to

reproduce totally or partially the chemical behaviour of more complex living systems. In this regard, to find good models of interaction between metal ions and biomolecules is of great significance.

Cr(III) complexes with L-cysteine have been thoroughly identified after Cr(VI) reduction [8-10]. In consequence, the coordination compound $\text{Na}[\text{Cr}(\text{L-cys})_2] \cdot 2\text{H}_2\text{O}$, which in solution originates the complex anion $[\text{Cr}(\text{L-cys})_2]^-$, has been synthesized, characterized and used as a model compound of an intracellular resulting product from Cr(VI) reduction by L-cysteine. Moreover, its Cr-S bonds show "unusual" substitution kinetics by acid hydrolysis, behaving in a different way of the "traditional" Cr(III) complexes, which are considered kinetically inert, as they are rapidly and reversibly hydrolyzed in a pH range similar to physiological pH [8].

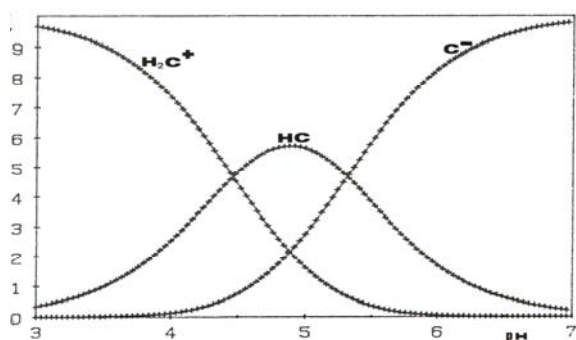

Figure 1. Speciation, in aqueous solutions (pH 3-7) of $[\text{Cr}(\text{L-cys})_2]^-$, (yy axis = molar fraction-□) [6]

2. Ring opening and closing of Cr(III)-S bonds in $[\text{Cr}(\text{L-cys})_2]^-$ complex anion

2.1. Speciation of $[\text{Cr}(\text{L-cys})_2]^-$ in aqueous solutions

The most relevant aspect of the coordination compounds of Cr(III) is their kinetic inertness, but Cr-S linkages are labile and reversible. This linkage hydrolyzes rapidly, in both basic and acidic media, in a reversible manner. The literature mentions some detailed studies of hydrolysis of Cr(III) complexes in acidic media, but had not paid any attention to reactions at pH closer to neutrality [11]. Studies of the equilibrium and hydrolysis of the anion $[\text{Cr}(\text{L-cys})_2]^-$, between pH 7 and 4.5, *ie* in moderately acidic media, have been conducted by UV-Vis.

The mechanism of hydrolysis can be explained by equilibria (1) and (2), which clearly show the simultaneous protonation and Cr(III)-S linkages breaking.

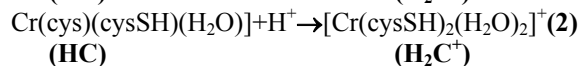
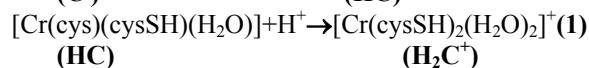
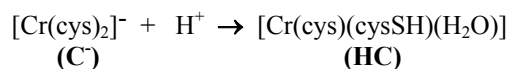

Protonation acidic constants were calculated by potentiometry: $\log K_1 = 4.46$ and $\log K_2 = 5.31$. The speciation graphic (Fig 1) shows the chemical species in solution according to solution pH [12].

2.2. Reactions involving Cr-S bond breaking and formation

When an acid is added to an aqueous solution of $[\text{Cr}(\text{L-cys})_2]^-$ it can be observed an immediate solution colour change, from blue to purple-violet, or to red, depending on the amount of added acid. These colour changes are associated with the type of alterations in the nature and quantities of the chemical species present in solution. The blue color (pH = 7) is attributed to the complex ion $[\text{Cr}(\text{L-cys})_2]^-$, the red one (pH ~ 4) to the "fully Cr-S opened" species $[\text{Cr}(\text{L-cysSH})_2(\text{H}_2\text{O})_2]^+$ and the intermediate colour, purple-violet (pH = 5-5.5), to the neutral complex $[\text{Cr}(\text{L-cys})(\text{L-cysSH})(\text{H}_2\text{O})]$, or to a mixture of anionic, neutral and cationic species. These colour alterations are consistent with the observed UV-Vis spectral variations. In the visible region, as the pH of the solutions decreases, both the position (λ_{max}) and the profile of the bands begin to change with the amount of added acid, from two bands and two associated shoulders towards the formation of only two single bands, observed even at $\text{pH} < 4$, with the simultaneous total disappearance of the shoulders. Besides, the band at higher λ suffers an hypsochromic effect (The results here described can be interpreted in terms of the conversion of the initial chromophore $\text{CrN}_2\text{O}_2\text{S}_2$ into another chromo-phore CrN_2O_4 , since the chromium coordination spheres were altered by the substitution of Cr-S by Cr-OH₂ bonds. In another study of the same compound two free SH groups per mole of complex were identified, in acidified solutions, indicating that the

protonation took place at the coordinated S atoms, during the process of Cr-S bond breaking. The spectral changes observed in the UV-Vis match the reduced intensity of the LMCT band $S \rightarrow Cr$ and are similar in identical experimental conditions [8,13].g 2).

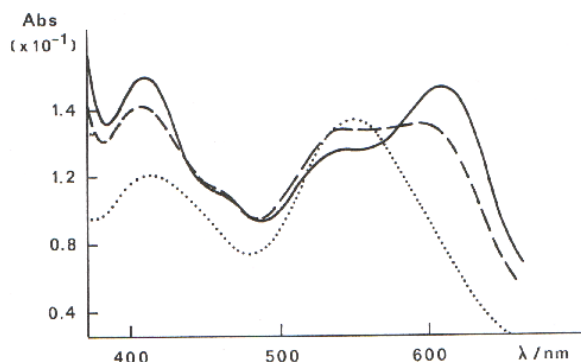

Figure 2. Electronic spectra (Vis) of $[Cr(L-cys)_2]^-$ (aq. sol 1.0×10^{-2} mol/L); (—) pH=7.3, (---) pH=4.7 and (···) pH=3.5 [13]

The effects caused by acid addition can be reversed, at least partially, between pH 7 and pH 4 by the addition of an equivalent amount of base, verifying the tendency to regenerate the initial spectra. Although fast, this reversibility is not instantaneous.

It was proved by UV-Vis that after 48 hours there is still a slight "displacement" of the spectrum towards the initial spectrum, in aqueous solution. When solutions of the complexes are allowed to stand at pH less than 4, there appears to be competition between the hydrolysis of Cr-S and of Cr-N and Cr-O bonds, which may explain the observed irreversible spectral changes for longer periods of time.

Some authors have proposed, for complexes of Cr(III) of the type $[(en)_2Cr(SXCOO)]^+$ ($X = -CH_2-$; $-CH_2CH_2-$; $-C(CH_3)_2-$), that a protonated pendant thiol could "assist" the hydrolysis of the adjacent bonds by an identical mechanism to that known in Organic Chemistry as "anchimeric assistance". That "help" caused by a protonated thiol and/or thioether, occurs in internal nucleophilic substitution reactions. The thiol group, which is pending after being protonated, can then favour the hydrolysis of the adjacent bonds Cr-N and Cr-O. The relative rates of these reactions will depend mainly on the size and on the "angular" strain of the formed ring after the nucleophilic attack by the pending protonated group [14].

It can be noted, for example, that in the above

compounds the rate constant for the cleavage of the Cr-N bond induced by the thiol group is $k \sim 10^{-4} s^{-1}$, which is about two orders of magnitude higher than in Cr(III) complex with amines ($k \sim 10^{-6} - 10^{-8} s^{-1}$) in which there is not any thiol group present. And it is of the same order of magnitude of the rate constant of the ring opening determined for our complex. bis(cysteinate)chromate(III) [8].

2.3. Kinetic studies of ring opening and closure involving Cr-S bonds, in neutral or moderately acidic media

The prior knowledge of the protic equilibria of the anion complex $[Cr(L-cys)_2]^-$ allows the study of the Cr-S ring opening and closing for pH 7 - 5.5, since for lower pH values one would tend to a mixture of the three chemical species in equilibrium (H_2C^+ , HC e C^-) (See equations 1 and 2, and Fig. 1). The pseudo-first order rate constant for the ring-opening was determined and its value is $5.05 \times 10^{-4} s^{-1}$ (pH = 5.5; 25.5 °C, $I=0.1$). Therefore, Cr-S bond is rapidly hydrolyzed [8,13].

If the hydrolysis of $[Cr(L-cys)_2]^-$ is directed in order to control the formation of $[Cr(L-cys)(L-cysSH)(H_2O)]$, that is, to the opening of "just one" ring, the UV-Vis spectra, corresponding to HC and C^- , can be identified. Initially by adjusting the complex aqueous solution pH to a constant value of 5.6-5.7 there is consumption of H^+ and the spectra keep changing in the direction of the typical spectra at those pH values (see Fig. 2).

The transformation of C^- in HC can then be modeled as a simple system. Neutralizing this solution with a pH 7 buffer solution, the ring closure is total, fully shifting the equilibrium to C^- species. In the studied pH region the rate of ring closure is independent of the H^+ concentration and of the buffer type. The obtained results led us to the following rate laws according to following equations (3) and (4), which suggest the mechanism depicted in Fig. 3.

$$k_{obs} = k K_a / [H]^+ + K_a \quad (3)$$

$$rate = k [C_0] \quad (4)$$

Since the ring closing rate does not depend on the acid concentration ($K_a \gg [H]^+$ - equation 3), K_a can refer to a RSH group or to a coordinated H_2O molecule in $[Cr(L-cysSH)(L-$

cys)(H₂O)]. The reaction rate constant should then be an unimolecular rate constant, corresponding to the ring closure of the deprotonated complex, allowing to calculate the activation parameters $\Delta H^\ddagger=32.7 \text{ kJ mol}^{-1}$ and $\Delta S^\ddagger=1.49 \text{ JK}^{-1}\text{mol}^{-1}$, which translate a concerted mechanism for the proton transfer and the ring closure [12].

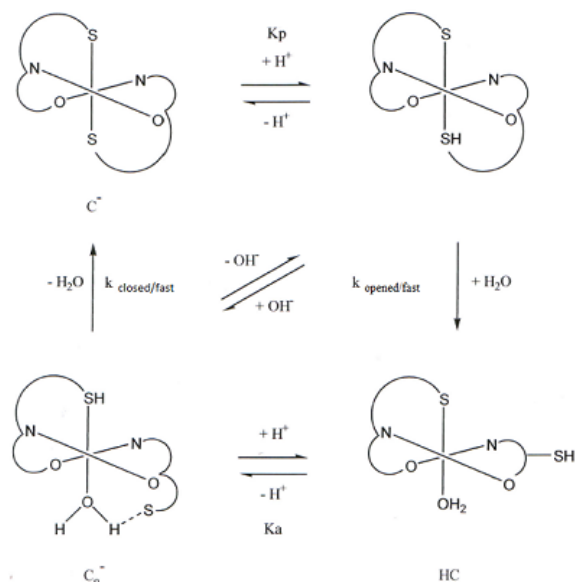

Figure 3. Opening/closing mechanism of Cr-S linkage in $[\text{Cr}(\text{cys})_2]^-$ [8,12]

3. Experimental

3.1. Specific objectives

- i) To synthesize a Cr(III) complex with L-cysteine;
- ii) To recrystallize the obtained solid;
- iii) To characterize the solid by electronic spectroscopy (solution UV-Vis) and diffuse reflectance (solid state) and compare and conclude on the formulation of the chemical species present in the solid state and in aqueous solution;
- iv) To identify the nature of the bands observed in the complex electronic spectra;
- v) To characterize the compound by infrared spectroscopy and identify the bands corresponding to the relevant vibration modes of the ligand and the complex;
- vi) To study, by UV-Vis spectroscopy, the Cr-S hydrolysis in moderately acid solution (pH 7-5.5) and to observe the solutions colour changes;
- vii) To verify, qualitatively, the reversibility of the Cr-S breaking by equivalent base addition;

3.2. Experimental methodology

3.2.1. Synthesis and solution kinetic study of the complex $\text{Na}[\text{Cr}^{\text{III}}(\text{L-Cys})_2]$

Synthesis of the compound $\text{Na}[\text{Cr}^{\text{III}}(\text{L-Cys})_2]$, following methods from literature [8,12-14], and characterization by solution and solid state UV-Vis spectroscopy.

Kinetic studies of the above compound, by UV-Vis, of the hydrolysis of the Cr-S bond opening in the pH range 7-5 (aqueous solution) as well as the reversibility of the Cr-S bond (opening/closing).

3.2.2. Research and Discussion

The biological role of the elements: the example of chromium which is considered one of the essential trace elements; its "double" character so that is considered one essential when as Cr^{3+} , despite being also classified as carcinogenic and mutagenic if in +6 oxidation state [15]; the recent controversy regarding its true safety as a worldwide used nutritional supplement [16].

3.2.3. Analysis / Discussion

The relationship between the properties *versus* chemical behaviour in solution of an element and the associated mechanisms of its essentiality *versus* toxicity is discussed. A bibliographic search for updating publications and "news" about chromium will be guided in order to enrich the discussion.

4. Concluding remarks

Bioinorganic is nowadays one of the very important chapters both of Inorganic Chemistry and Biological Sciences [17]. In this context the described practical activity can be taken as an inter-disciplinary case study covering Coordination/Inorganic Chemistry and Bioinorganic (transition metal bonding to biomolecules) Moreover, it can be easily integrated in the Portuguese Physics-Chemistry High School 12^o Year Programs (1.1-Metals and Alloys / 1.3.3 – Metals in human body).

The experimental component of this practical activity has already been tested in practical disciplines, such as Inorganic Chemistry or Bioinorganic Chemistry, for students of Chemistry and Biochemistry, in the Chemistry Department of the University of Aveiro, Portugal and good results have been attained. Students

were very receptive to this mixed-subject practical work[18].

5. Acknowledgements

Chemistry Department (University of Aveiro), CICECO (Associate Laboratory, University of Aveiro) and Foundation for Science and Technology (FCT, Portugal) are acknowledged for financial support.

6. References

- [1] Schwartz AT, Serie J. *Journal of Chemical Education* 2001; 18(11): 1490-1494.
- [2] Abdella BRJ, Walczak MM, Kandl KA, Schweinfus JJ *Journal of Chemical Education* 2011; 88: 1257-1263.
- [3] Wolfson AJ, Hall ML, Allen Mm *Journal of Chemical Education* 1998; 75(6): 737-739.
- [4] Barreto JC *Journal of Chemical Education* 2000; 77(12): 1548.
- [5] VanHecke GR, Karakstis KK, Haskell RC, McFadden CS, Wettack FS *Journal of Chemical Education* 2002; 79(7): 837-844.
- [6] Sumter TK, Owens PM *Biochemistry and Molecular Biology Education* 2011; 39(2): 110-116.
- [7] Quievryn G, Goulart M, Messer J, Zhitkovich A *Molecular and cellular Biochemistry* 2001; 222: 107-118.
- [8] Santos TM. Chromium coordination chemistry related to biological effects of Cr(III) and Cr(VI) compounds. PhD Thesis: University of Aveiro, Aveiro, Portugal; 1995.
- [9] Lay PA, Levina A *Inorganic Chemistry* 1996; 35: 7709-7717.
- [10] Kaiwar SP, Sreedhara A, Raghavan MSS, Rao CP *Polyhedron* 1996; 15(6): 765-774.
- [11] Asher D, Deutsch E *Inorganic Chemistry* 1972; 11: 2927-2933.
- [12] O'Brien P, Pedrosa de Jesus J, Santos TM, *Inorganica Chimica Acta* 1987; 131: 5-7.
- [13] Santos TM, Pedrosa de Jesus J, O'Brien P. *Polyhedron* 1992; 11(13): 1618-1695.
- [14] deMeester P, Hodgson DJ, Freeman HC, Moore C, *Inorganic Chemistry*. 1977; 16: 1494-1498.
- [15] Vincent JB. *Dalton Transactions* 2010; 39: 3787-3794.

- [16] Porter DJ, Raymond LW, Anastasio GD, *Archives of Family Medicine* 1999; 8: 386-390.
- [17] Housecroft CE, Sharpe, AG. *Inorganic Chemistry*. London: Prentice Hall, 1st ed; 2001; Shriver DF, Atkins PW. *Inorganic Chemistry*, Oxford: Oxford University Press, 3rd ed.; 1999.
- [18] Practical Guides for "Química 606" and "Laboratórios QI - 1", Department of Chemistry, University of Aveiro, Aveiro, Portugal; 2000.



BIOCHAR HANDS-ON EDUCATION

**Tomáš Milěř, Jan Hollan,
Jindřiška Svobodová**

*Faculty of Education, Department of
Physics, chemistry and vocational education,
Masaryk University, Poříčí 7, 60300 Brno,
Czech Republic
tomas.miler@mail.muni.cz*

Abstract. *Biochar topic integrates natural, environmental and social sciences and it is an ideal topic for integrating school subjects at all grades. Several schools worldwide have been reported to perform biochar hands-on projects. Pupils don't just learn what has been discovered a long time ago. They actually become scientists doing their own research and have a chance to contribute to common open-source knowledge. In this paper we present several hands-on activities related to biochar.*

Keywords. biochar, education, hands-on science

1. Introduction

Biochar (carbonized biomass) has been a subject of booming scientific research for the period of past decade. Specialists of many different fields became interested in biochar research mainly because of its potential for: 1. climate change mitigation through carbon sequestration, 2. soil amendment and 3. energy source.

As shown in the graph below number of scientific articles on biochar has been growing exponentially in the last decade.

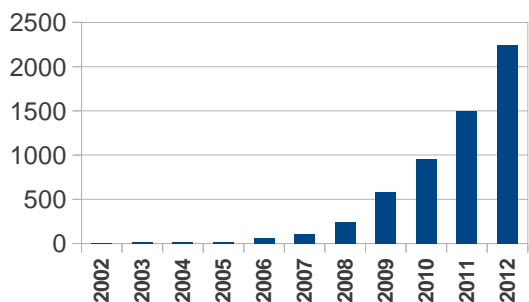

Figure 1. Number of scientific articles containing keyword "biochar" in the abstract (Source of data: Google Scholar)

We claim that science education ought to reflect advances in scientific research and keep the state of knowledge communicated at public schools up-to-date.

2. Biochar educational potential

Educators all around the world have been discovering biochar as a great learning topic suitable for all levels of schools. During biochar activities pupils learn scientific research methods and they actually work almost like real scientists. Biochar topic is ideal for integration of natural science subjects and can be used to teach about global environmental issues.

International Biochar Initiative (IBI) presents examples of successful biochar school projects on their websites (<http://goo.gl/dVnLI>). Up to our knowledge we have been the first ones in the Czech Republic engaged in development of biochar educational activities. In this paper we present several educational hands-on activities that were performed by pupils of upper primary school and at the Faculty of Education by pre-service physics teachers. From our own teaching experience and from reports of other schools presenting their biochar projects we summarize the following findings:

1. Biochar hands-on activities can be performed as laboratory experiments or as field trials. For outdoor field experiments we recommend to follow IBI methodology available on-line as a pdf document named "A Guide to Conducting Biochar Trials" (<http://goo.gl/FfVda>).
2. Biochar hands-on activities can be performed as individual projects of pupils (students) or as small team, class and whole school project.
3. Biochar hands-on activities can be performed as a single lesson or long time projects. For most of existing activities longer period is required,

specially for activities based on comparing growth of plants in ordinary soil and in soil containing biochar.

4. Areas to investigate and examples of activities:

- biochar production (source of biomass, pyrolysis process, biochar yield...)
- stove design (improving gasifier stove design, determining thermal efficiency of stove by Water Boiling Test)
- biochar properties (pH, fraction, composition, density...)
- soil amendment (plants growth, pH change, water retention capacity...)

3. Sample activities

In this chapter, sample hands-on science learning activities are presented.

3.1. Gasifier stove made of cans

School willing to engage in biochar hands-on learning activities need a source of biochar. The easiest way is to get it is buying a bag of charcoal for grilling and crush it to powder. This is useful when you need large amount of biochar for field trials. Small amount of biochar for classrooms experiments can be produced in TLUD (Top-Lit Updraft) gasifier stoves. TLUD pyrolysis system was invented in the 80's and it has been handled as open source technology. That means TLUD design is not patent protected and is free to use and innovate. Currently there is only one type of TLUD stove commercially produced by Spenton LLC (<http://www.spenton.com>). Their Campstove was designed for use in camping sites. It uses battery powered fan to sustain updraft and regulate stove's power.

Simplest TLUD stove can be made of just one tin can (named "iCan"). It works well under calm conditions. A more reliable and efficient design uses 3 cans, for chimney, inner and outer wall. Scheme of such a stove is on a Figure 2.

Biomass placed inside the smaller can is lit at the top layer. When it gets hot, flaming pyrolysis starts to move downward while air enriched by wood gas moves upward. Combustible gases (CO, CO₂, H₂) mix with preheated air sucked through hollow metal wall and burn. Flames come from holes at the top of inner can. After flames extinguish the stove contains hot char which must be immediately moved to airtight container in order to prevent char oxidation.

When char cools down, it is ready to use for any school experiment.

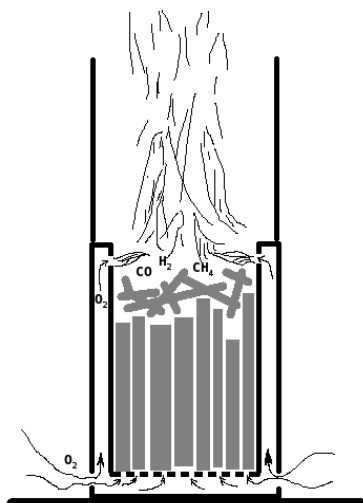

Figure 2. Scheme of TLUD stove made of three cans.

Making and operating the stove is a great learning activity itself. Pupils can try to improve the stove design and can do lots of measurements (temperature of flame or pyrolysis zone, duration of burning of different fuels, factors affecting biochar yields, thermal efficiency of stove etc.). For safety reasons, the stove should be operated outdoors or in a ventilated fume hood, as woodgas contains carbon monoxide which is very toxic. Pupils should be well instructed how to safely handle the stove because its surface gets very hot and they could burn their fingers. Fire protection measures should also be considered.

3.2. Soil properties measurement

Biochar is usually recommended to be mixed with soil in order to improve its physical properties. There are many interesting questions that can be investigated by pupils through laboratory experiments. Below we present our sample measurement of three soil properties: water retention capacity, pH and conductivity. We tested, how biochar changes these properties for three kinds of soil: peat (as offered to gardeners), agricultural soil (collected on a field) and sand. Mixture ratio of soil and biochar was 1:1.

Equipment: laboratory glass, filtration papers, Vernier LabQuest and detectors: electronic scale, pH meter, conductivity meter

Procedure:

1. Weigh 10 g of air-dried soil sample.
2. Measure 40 ml of distilled (or tap) water.

3. Place the soil sample onto filtration paper (see figure below) and let all 40 ml of water drop on the surface of the sample.



Figure 3. Collecting drops of water passing through the soil

4. Collect water passing through the sample until no more filtered water flows or drops.
5. Gently move the filtration paper with the wet sample to the scale and measure its weight. From that weight, subtract 10 g (dry sample) and 2 g (wet filtration paper). The final number is the weight of water retained by the sample.
6. Measure pH and conductivity.
7. Wash the sensors and glass in clean water every time.

Standardized procedure of determining soil pH (its suspension in water) is specified in ISO 10390:2005. According to that standard, water solution should contain potassium chloride (KCl) or calcium chloride (CaCl₂). For school experiments we used simplified method which is sufficient to determine change of soil pH after mixing with biochar (not exact soil pH).



Figure 4. Measuring pH of a soil suspension in water using Vernier sensor.

Results of our measurements are shown at Figure 5. We found that peat has the highest retention capacity for water and sand the lowest. Biochar addition increased retention capacity of sand but for the given agricultural soil, retention capacity was reduced. That explains why biochar is

recommended for sandy soils mostly. More experiments can be done to investigate how fast can water pass through the samples or how fast will a given agricultural soil lose water compared to soil+biochar mixture (using Vernier soil moisture sensors). That might be important for understanding of soil behavior during rains or droughts.

Our measurements also revealed that biochar increased pH (decreased acidity) of all our samples – peat, soil and sand. Agricultural soils affected by long time use of mineral fertilizers are often acidic and biochar can help farmers to improve soil pH.

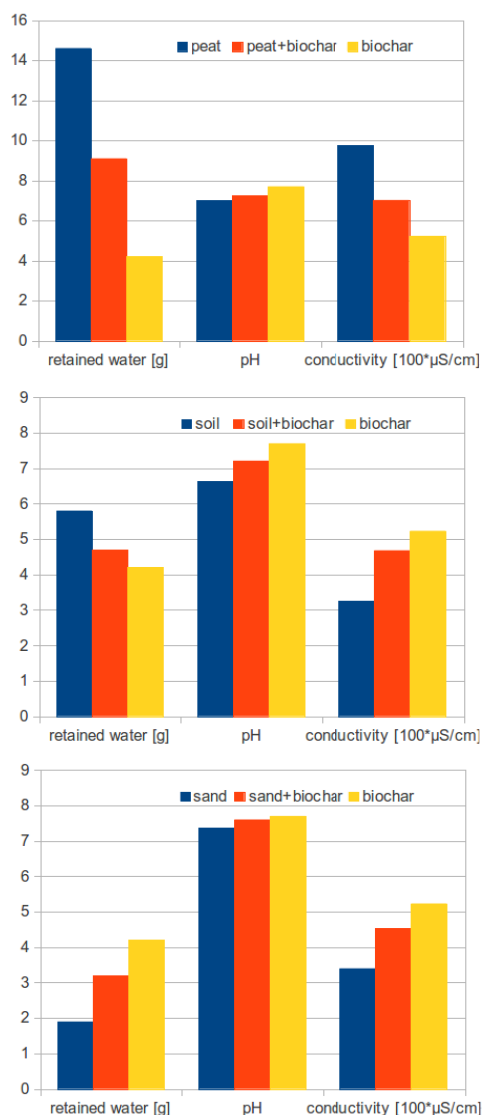

Figure 5. Sample measurements of three soil properties: 1. water retained in 10 g of substance, 2. soil pH, 3. conductivity.

The highest electrical conductivity was achieved for peat alone. Addition of biochar to sand and to

agricultural soil increased their conductivity. That finding might have application in building industry for decreasing ground resistance of electrical installations and lightning rods.

Pupils can investigate even more properties of soil depending on their interest and school laboratory equipment available.

3.3. Czech school biochar project

The Czech republic has participated in the international GLOBE Program (The Global Learning and Observations to Benefit the Environment, <http://globe.gov>) since its beginning in 1995. Czech Republic is among 111 participating countries with 142 primary and secondary schools currently engaged. Every year, pupils from over 30 schools meet at GLOBE Games (www.globegames.cz/english.html).

In 2010 pupils of the primary school ZS Křídlovická explored biochar and prepared its presentation for the GLOBE Games in Svitavy. Pupils made a TLUD stove from cans and experimented with microgasification. They carbonized 10 different biomass samples (spruce wood, beech wood, pine cone, larch cone, hazelnut, walnut, corn cob, apricot pit, peach pit, cork stopper). At the GLOBE Games festival in a city park they demonstrated TLUD stove to the event participants and townspeople.



Figure 6. Demonstration of TLUD stove made of cans by 8th grade pupil.

Pupils of the Czech school also prepared a task for the visitors coming to their stand. On the table they arranged 10 samples of carbonized biomass. The visitors were asked to identify original source of biomass for each sample choosing from a given list. The samples were mostly easy to recognize, because by carbonization biomass reduces its size but the shape remains the same. Even small children were able to complete the task with a little help of their parents.



Figure 7. Presentation of carbonized biomass samples.

More photos from the event are available on-line at the address: <http://goo.gl/RlqGm>

4. Conclusion

Biochar is a brand new area of interdisciplinary science research. Educators have been seeking ways how to implement this topic into current education system. For many reasons, biochar appears to be a unique educational tool. In the paper we presented several hands-on science activities on biochar that can be utilized in primary, secondary or university science education.

5. Acknowledgements

Hands-on biochar activities were developed and performed at Faculty of Education, Masaryk University in the frame of project no. CZ.1.07/2.2.00/28.0182 “Modules – innovation of physics and chemistry teaching and learning”.



FACTORS INFLUENCING ATTITUDE TOWARDS DISSECTIONS IN SCHOOLS

Jana Fančovičová¹, Andrea Lešková²

¹Department of Biology, Faculty of Education,
Trnava University, Trnava, Slovakia

²Institute of biological and ecological sciences,
Faculty of Natural Sciences, P.J. Šafárik
University, Košice, Slovakia

andrea.leskova@upjs.sk

fankaj@gmail.com

Abstract. *An essential part of the biology teaching, especially zoology teaching, should be dissections. They allow the acquisition of knowledge and skills in anatomy and understanding of the structure of the internal organs of animals. The effectiveness of dissections is influenced by several factors such as student attitude to dissection, previous experience and emotion of disgust. We investigated, what are the preferences of 396 university students in the issue of dissections. We were interested in the factors which influenced their attitude to dissections. Pre-service teachers perceive dissections positively and they want to participate on them. Respondents who reported higher disgust to dissections less agreed with them, while female students that have never done dissection, reported higher disgust. The higher disgust was recorded at students who keep animals. Students understand the importance of dissection in teaching and prefer real dissection to virtual one. The more students understand the importance of dissection, the more they agree to use it in teaching. It has been confirmed that previous experience with real or virtual dissection has positive influence on the elimination of the dissection disgust.*

Keywords: animals, attitudes, dissection, disgust

Introduction

The aim of anatomy and physiology is the understanding of structures of the body, its functioning, which enables us to understand the function of any organ or an organism as a whole. People in ancient times wished to know the functioning of their bodies, and especially to know the causes of pain and disease. A man began to realize its difference since primitive society. The basic information about the human

body appeared about 3000 BC. in the Chinese letter "No - qing", with first evidence about the human circulatory system. The knowledge about the human body was built with the sacrificial rites of animals or humans from Egypt. Important medical schools appeared in Greece – the school of Hippocrates. Similarly, other scientists such as Aristotle, or Galen contributed to the knowledge of the human body. Feudalism period was heavily influenced by religion, which influenced and medicine. Religious attitudes had negative consequences on the building any knowledge about the human body, because human was considered to be a work of God. Dissections were therefore banned by church. Descartes contributed to brain research, Vesalius considered the major reformer of the anatomy as a separate scientific discipline.

Modern age tradition of the use of dissection in biological education started in the 20th century (Kinzie et al., 1993). Dissection has become part of education at home and abroad, including practical training at universities with a focus on biology, whose aim is to develop skills, attitudes and proper understanding of the structure and functions of organs (Wiles 2012). However, there are arguments against the implementation of dissections in teaching biology (Orleans 1988; Texley 1992). There are probably more causes of this trend (Predavec 2001), where they can find for example in protection of animals (Pope 1995) and in teachers (Texley 1992) or in the pupils themselves (Snyder et al., 1992), because there have been observed (especially at girls) negative attitudes towards the use of animals in teaching (Miletts & Lock 1992). Question about the alternative dissection revived in the late 80's, when started to be intensively discussed. Ethics of dissections in schools (Orleans 1988, Downie & Alexander 1989, Texley 1992) and violations of the animal laws (Langley 1991, Pope 1995) were further arguments against dissections. Virtual dissections brought many advantages such as possibilities of detailed oversight of internal organs, the opportunity to work at their own pace, at any time, working in any environment, elimination of odor and other factors (Predavec 2001). Opponents of virtual dissections (Offner 1993), however, argue that the virtual world can not provide equal educational opportunities - students can not apply their knowledge to the real world and do not develop their psychomotor skills (Duhropf 1998).

National Association of Biology Teachers

(NSTA 2005) is an official association of biology teachers in the U.S. Many US students have the opportunity to decide for themselves whether they will realize dissections or not. In Argentina, for example, dissections are prohibited in all schools. Teachers in Australia are voluntarily allowed to incorporate dissections into their curricula. Countries such as the Netherlands, Poland, Switzerland and Israel does not allow the implementation of dissections to schools.

The Slovak republic has issued Law no. 543/2002 on the protection of nature and landscape on which option is limited dissections in schools: According to § 4 (3) "shall be prohibited to capture and kill animals to their natural range. This prohibition does not apply if the capture or killing takes place in the implementation of research activities or if there is an imminent threat to the life or health of a person or damage to his property, or where the special regulations".

To implement dissections in education teachers express their opinion, the researchers provide the latest scientific research, companies argue the advantages and disadvantages of dissections. But what are the opinions and attitudes towards real and virtual dissection by students - future teachers?

The aim of the study was to identify attitudes of students toward dissections and the role of emotions in acceptance of dissections. We have chosen prospective biology students for this research, because dissections may improve their knowledge and skills necessary for their biology teacher job in school practice.

Methods

A total of 397 students from Trnava University and P.J. Šafarik university participated in the research. The questionnaire consisted of 28 items related to the five domains: disgust, importance, the use of dissections in schools, implementation of dissections to schools and virtual autopsies. The questionnaire showed sufficient reliability (Cronbach's alpha = 0.93), and Cronbach alpha calculated for each domain ranged between 0.77 and 0.9. Domains were specified according to results of factor analysis (PCA). Factor loading of accepted items had values 0.5 and more.

Results

According to the values of the mean scores, we

found that the attitude towards implementation of dissections was highly positive. Biology students of both universities understood the importance of dissections and did not have negative attitudes toward dissections. However, lower mean scores were found in the domain Disgust and The use of dissections in schools suggesting that students are against the use of dissections in elementary schools and in high schools.

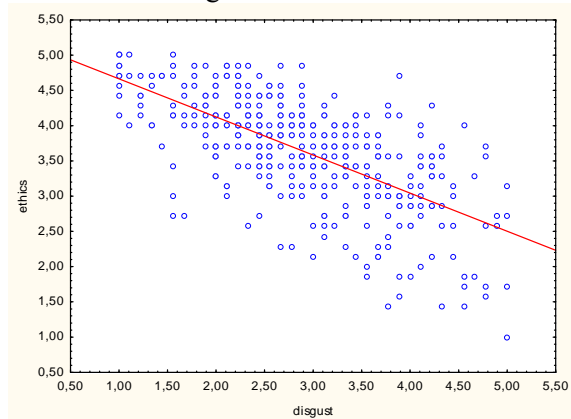

Figure 1. Correlation between dimensions "Disgust" and "Ethics"

Using correlation analysis (Pearson r), we found that the all the domains correlate with each other, while correlations were mostly moderate ($r = 0.2 - 0.5$). Strong correlations were found in domains Importance of dissection and Ethical domain of dissections and between Disgust and Ethical domain. The more the student understood the importance of dissection, the greater the support of dissection in education. High disgust of dissection correlated with un-supportive use of dissection in schools (Fig. 1).

Multivariate analysis of variance (MANOVA), where the dependent variables were mean scores of all attitude domains and predictors were gender, experiences with dissection and having an animal at home was used to test whether these factors influenced attitudes toward dissections. Females showed higher disgust of dissection than males ($p < 0.001$).

Statistically significant r ozdiel has also been confirmed in an interaction gender \times experience with dissection. Females who never experienced dissection showed higher disgust of dissections compared with experienced females. No similar differences were found in males. (Fig. 2).

According to the students the actual implementation of dissections students acquire real ideas about anatomy of animals and dissections should be part of biology education. Males scored higher in the domain Importance of

dissection than females ($p < 0,05$).

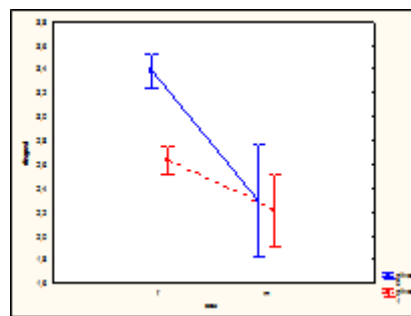

Figure 2. Relationship between sex and experience with dissection with disgust

Most of the students disagreed with dissections in secondary education, but this disagreement was higher for females. On the other hand, students do not have problems with implementation of dissections into universities. Males generally supported the use of dissections in schools more than females ($p < 0,001$). Respondents who reported to have animals at home showed higher disgust of dissection than non-animal owners. Urban students showed higher disgust of dissections than rural students. It may be that this difference is caused by more frequent breeding of farm animals in villages. Opinion on the feasibility of dissections in secondary education has changed in third grade students and remained unchanged in fourth grade students. It is probable that the realization of real dissections in the third grade in zoology lessons influenced student opinions regarding dissections.

A similar trend, albeit opposite, was found in the domain Disgust of dissections. There was also decreased disgust of dissections in third graders. Similarly, we suggest that practical experiences with dissections in this grade are responsible for lower mean score of disgust of dissection domain. This fact

Another finding was that students who have already experienced a virtual dissection suggested that virtual dissection is equivalent to real dissection. Interestingly, experience with virtual dissection was associated with lower disgust of dissection similarly than experience with real dissection ($p < 0,001$, Fig. 3). No similar associations were found in other domains.

Discussion

Knowledge about student attitudes toward

dissections are important especially due to increasing their effectiveness, because negative attitudes negatively correlate with achievement (Randler et al., 2005).

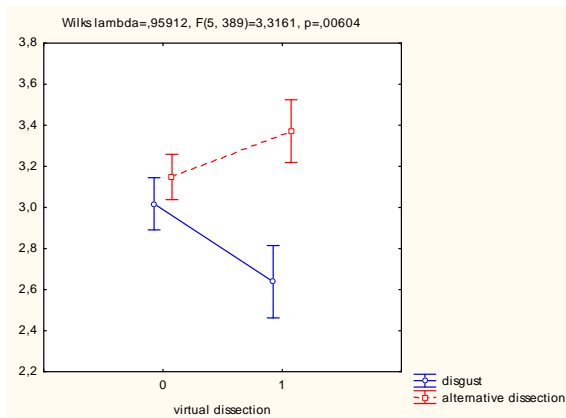

Figure 3. Relationship between experience with alternative dissection with disgust

Discussion

Knowledge about student attitudes toward dissections are important especially due to increasing their effectiveness, because negative attitudes negatively correlate with achievement (Randler et al., 2005). We were interested in factors affecting attitudes to implementation of dissections in teaching biology that may enhance knowledge about anatomy and practical skills. We found that only a quarter of respondents had experiences with virtual dissection and more than 60% of the students had experience with real dissection in education, which means that Slovak teachers rarely use virtual dissection in the classroom.

Students understand the importance of dissections in teaching biology and were reserved about the use of animals for educational activities. Students suggested that the implementation of real dissections is beneficial in terms of increased anatomy knowledge supporting the view of Offner (1993), who also suggests that real dissections have greater value than virtual dissections. Quince et al. (2011) found that the majority of medical students in the UK has a positive attitude towards the implementation of dissections, which is expectable. In agreement with this, Akpan & Andre (1999) found that a higher level of knowledge students acquire when real dissection was preceded by virtual dissection. This finding was confirmed by the analysis in which the inexperienced students from first and second

grade were less supportive toward dissections than older, and thus experienced students.

Gender differences in attitudes toward dissections were significant. Female students showed higher disgust of dissections than males. Females generally have a more negative attitude towards dissection (Akpan & Andre, 1999), possibly reflecting their higher disgust sensitivity compared to men (Fančovičová & Prokop, 2013). Higher disgust of dissections was also shown in female students who lacked experiences with dissections. Respondents who kept any animal at home showed higher disgust and less supportive attitudes toward dissections in school of dissections than non-animal owners. This can be explained by higher empathy toward animals in animal owners (Ascione 1992).

Conclusion

We have found that students do not have a problem realizing real dissections in the educational process. Comparison of gender differences showed that men have more supportive attitudes toward dissection than women. Attention should be focused primarily on women because they perceive dissections differently than men. Other factors that influenced preferences of dissections were for example having an animal at home and sensitivity in disgust domain. Animal owners did not agree with the implementation of dissections in schools. It seems that disgust was reduced after experiences with virtual dissection, thus virtual dissections would be useful and cheap tools for science teachers. Again, some caution should be paid on females who have generally less positive attitudes toward computers than males. For their future biology teachers, pupils and students needed to dissect, whether virtually or really, to eliminate misconceptions about internal organs of animals. Special attention should be paid mainly females and animal owners.

The present research was supported by the project VEGA no. 1/0124/11.

References

- [1] Akpan JP, Andre T. 1999. The effect of a prior dissection simulation on middle school students' dissection performance and understanding of the anatomy and morphology of the frog. *Journal of Science Education and Technology*, 8(2): 107–121.

- [2] Ascione FR. 1992. Enhancing children's attitudes about the humane treatment of animals: Generalization to human-directed empathy. *Anthrozoös*, 5(3): 176–191.
- [3] Balcombe J. 2001. Dissection: The scientific case for alternatives. *Journal of Applied Animal Welfare Science*, 4: 118–126.
- [4] De Villiers R, Monk M. 2005. The first cut is the deepest: reflections on the state of animal dissection in biology education. *Journal of Curriculum Studies*, 37(5): 583–600.
- [5] Duhropf R. 1998. Dissection alternative: Comparison of MacPig to fetal pig dissection in college biology. *The American Biology Teacher*, 60(3): 228–229.
- [6] Fančovičová J, Prokop P. 2008. Students' attitudes toward computer use in Slovakia. *Eurasia Journal of Mathematics, Science & Technology Education*, 4(3): 255–262.
- [7] Fowler HS, Brosius EJ. 1968. A research study on the values gained from dissection of animals in secondary school biology. *Science Education*, 52(1): 55–57.
- [8] Kinzie MB, Strauss R, Foss J. 1993. The effects of an interactive dissection simulation on the performance and achievement of high school biology students. *Journal of Research in Science Teaching*, 30(8): 989–1000.
- [9] Lock R. 1995. GCSE students' attitudes to dissection and using animals in research and product testing. *Journal Biology Education*, 77(279): 15–21.
- [10] Maloney R. 2005. Exploring virtual fetal pig dissection as a learning tool for female high school biology students. *Educational Research and Evaluation*, 11(6): 591–603.
- [11] National Science Teachers Association [NSTA] 2005. *Responsible use of live animals and dissection in the science classroom*. NSTA Position Statement. Retrieved February 27, 2013 from www.nsta.org/about/positions/animals.aspx
- [12] Oakley J. 2009. Under the knife: Animal dissection as a contested school science activity. *Journal for Activist Science and Technology Education*, 1(2): 59–67.
- [13] Oakley J. 2012. Science teachers and the dissection debate: Perspectives on animal dissection and alternatives. *International Journal of Environmental & Science Education*, 7(2): 253–267.
- [14] Oaten M, Stevenson RJ, Case TI. 2009. Disgust as a disease-avoidance mechanism. *Psychological Bulletin*, 135: 303–321.
- [15] Offner S. 1993. The importance of dissection in biology teaching. *The American Biology Teacher*, 55(3): 147–149.
- [16] PETA 2004. How animals are collected and killed for dissection and the alternatives you can choose, The PETA Guide to Animals and the Dissection Industry. People for the Ethical Treatment of Animals, Norfolk, VA.
- [17] Predavec M. 2001. Evaluation of E-Rat, a computer-based rat dissection, in terms of student learning outcomes. *Journal of Biological Education*, 35(2): 75–80.
- [18] Prokop P. and Fančovičová, J. 2013. Self-protection versus disease avoidance: The perceived physical condition is associated with fear of predators in humans. *Journal of Individual Differences*, 34(1): 15–23.
- [19] Quince TA, Barclay SIG, Spear M, Parker RA, Wood DF. 2011. Student Attitudes Toward Cadaveric Dissection at a UK Medical School. *Anatomical Sciences Journal*, 4(4): 200–207.
- [20] Randler C, Ilg A, Kern J. 2005. Cognitive and emotional evaluation of an amphibian conservation program for elementary school students. *Journal of Environmental Education*, 37(1): 43–52.
- [21] Wiles JR. 2012. Commentary on science teachers and the dissection debate: Perspectives on animal dissection and alternatives. *International Journal of Environmental & Science Education*, 7(4): 659–661.



IN-SERVICE TEACHER TRAINING IN IBSE IN SLOVAKIA AND ITS IMPACT ON TEACHERS AND STUDENTS IN THE FRAMEWORK OF THE ESTABLISH PROJECT

Zuzana Ješková, Katarína Kimáková,
Mária Ganajová, Marián Kireš

Faculty of Science, P.J. Safarik University
Košice, Košice

zuzana.jeskova@upjs.sk,
katarina.kimakova@upjs.sk,
marian.kires@upjs.sk,
maria.ganajova@upjs.sk

Abstract. *The Establish FP7-funded project is aimed at wide dissemination and use of an inquiry-based teaching method for science with second level students (age 12-18years) on a large scale in Europe. In order to meet this goal professional development workshops to support teachers in adopting inquiry-based science education (IBSE) methods have been developed and implemented across the participating countries. This paper describes the experience from in-service teacher training that has been carried out in Slovakia, results from the implementation of IBSE activities in classes and the follow-up activities.*

Keywords. Inquiry-based science education, physics teaching, in-service teacher training

1. Introduction

Since 2008 when educational reform was implemented into the educational system in Slovakia, the national curriculum gives significant attention to scientific inquiry with emphasis on students' active independent learning [1]. This approach is in good consonance with the European trends that emphasize the change in the methods of instruction towards more inquiry-oriented. However, Slovak teachers are not well-educated in this field and there is a lack of instructional materials for teachers to use in the classroom. Generally, at schools, there is a traditional teacher-centred approach dominantly used with a lack of student-oriented way of teaching.

The Establish FP7-funded project [2] offers a lot

of support in order to meet the challenge that teachers have regarding their different role in the classroom. The project main goal is wide dissemination and use of an inquiry-based teaching method for science with second level students (aged 12-18 years) on a large scale in Europe. Over the course of the project there have been a number of teaching and learning materials developed and the professional development in-service teacher training workshop has been designed in order to implement these in the national environment of the participating countries.

While implementing this in Slovakia, the whole process went in several steps. Firstly, teaching materials as well as the Establish teacher training workshop model [2] have been adapted to the national curriculum. Then, based on the adapted materials there has been an in-service teacher training carried out and teachers' attitudes and experience concerning inquiry-based science education (IBSE) have been collected. In the next step, teachers have been implementing the selection of the Establish project inquiry-based activities in their own teaching and the impact on students has been monitored and collected. Finally, these efforts of teachers have resulted in designing their own IBSE activities that have been presented and exchanged with other teachers.

2. In-service teacher training

Within the Establish project there was a model of teacher training programme developed [2]. The main goal is to provide support for teachers to be able to use inquiry-based approaches in their classrooms when teaching science. In order to do this, the Establish consortium has identified four core elements which will assist teachers to do this: Establish view of IBSE, industrial content knowledge, science teacher as an implementer (classroom management) and science teacher as a developer (reporting and reflecting about the classroom work). Apart from this there were additional elements identified, namely ICT, argumentation, research and design projects for students and assessment of IBSE.

In the period of November 2011 to February 2012, 50 secondary schools science teachers participated in an initial 4-days teacher training (12 hours) in IBSE. During the course aimed at learning about the IBSE methods and carrying out a lot of activities as examples of inquiry activities with different levels of inquiry they

were encouraged to implement IBSE in their classroom practise. The course focused mainly on 4 core elements, i.e. Establish view of IBSE, industrial content knowledge, how to implement IBSE activities, feedback and evaluation of the classroom work/analysis of classroom inquiry activities.

The average age of the teachers was 44 years, the majority were female (91%) and they varied in teaching experience from 1 to 37 years. Participating teachers answered a pre and post questionnaire about their attitudes towards IBSE before and after the course. All of them classified themselves as complete beginners in the field of IBSE. While before the course about 70% of teachers think that the use of inquiry is appropriate to achieving learning goals, after the course 94% of teachers agree with this statement. Also the disagreement with the statement “The inquiry is suitable only for very capable students” has changed from the initial 45,5% to almost 74%. Teachers’ tendency to use inquiry as their main teaching method has also slightly increased. Concerning the extent of occurrence of particular inquiry practices within the classroom, the answers show that there is a lack of independent learning in terms of students designing their own procedure for investigations, formulating research questions, determining the direction of the lab based on the students’ research questions, students very rarely decide which data to collect. The answers to these items in the post questionnaire when teachers experienced some inquiry activities in their classroom show slight shift towards higher extent of these practices.

3. Implementation of IBSE activities

The teachers participating in the course were supported to implement IBSE in their classroom practise. As a result, they implemented selected activities developed within the Establish project in their teaching (table 1). Each of the teachers implemented at least three IBSE activities. Students who participated in the experimental teaching were requested to answer questionnaires after each of the activity as well as pre and post questionnaires before and after a whole set of activities from the same unit. The questionnaires were developed by the Establish consortium members [3].

In the field of physics there were the Sound unit activities implemented and the results of questionnaire analysis [4] has shown the

following results. A total of 1302 upper secondary students answered questionnaire after each of the inquiry lesson that has been focused on intrinsic motivation assessing three dimensions: Interest/Enjoyment, Perceived choice and Value/Usefulness. Based on the responses to these questionnaire items it can be seen that the students’ opinion on the activities they carried out is positive; they consider them interesting and enjoyable. In the questions concerning the perceived choice students lack of strong opinion. In the items aimed at how students perceive the value/usefulness students express the provided activities were slightly useful for them.

Subject	Unit	Period	Second school	Teachers
Bio	Disability	Oct-Nov 2011	lower	4
			upper	4
	Blood donation	Jan-April 2012	Lower	5
			upper	5
	Water in the life of man	Jan-Feb 2013	lower	3
			upper	3
Phys	Sound	Feb-Sept 2012	Upper	14
		Feb-June 2012	Lower	2
Chem	Exploring holes	Nov-Dec 2011	Lower	5
		Nov-Dec 2011	Upper	2
	Polymers	Feb 2012	Lower	3
		Feb 2012	Upper	2

Table 1. Establish teaching units and their implementation into science teaching

A total of 202 upper secondary school students completed questionnaires before and after a series of activities. The results were compared using appropriate statistical testing. In this questionnaire several aspects were examined. A set of questions were used to assess how students perceive the role of science and technology in society. The answers indicate that students view on this question has not changed after experiencing IBSE. The positive shift has been indicated in the field of students’ opinion on learning and understanding science when students tend to think more strongly that remembering facts in science is not very important. However in other questions, such like their opinion on the formulas and their importance their attitude does not change. There

was a set of questions assessing students' opinion about science lessons and their attitude towards taking up career in science or technology. The analysis of this field shows that their positive attitude towards science lessons slightly increased however there is no significant difference in up-take of careers in science or technology after experiencing IBSE activities.

4. Follow-up activities

The ESTABLISH in-service teacher course in the extent of 12 hours have been completed by 50 science teachers who also experienced inquiry-oriented teaching in their own classrooms. However, the Slovak system of further teacher education is based on accredited courses that are offered by institutions that have permission to do this [5]. Teachers after completing such an accredited course are rewarded by credits that count for their career development. In order to fulfil these requirements the Establish in-service teacher course became a part of a longer-extent accredited teacher training course named Innovative methods of science education (65 hours/40 hours of present and 25 hours of distant part). 25 science teachers (12 physics, 6 chemistry and 7 biology teachers) continued with the training within the following 4 meetings up to December 2012. Altogether teachers took part at 8 present meetings and the distant part was carried out as pilot teaching with lessons observation and analysis and evaluation of classroom work. The extended part of the training was focused more deeply on core elements as well as on some of the additional education elements, i.e. the role of ICT in IBSE and research and design projects for students.

Table 2. List of activities and their level of inquiry developed by physics teachers

For the successful course completion teachers sit for a final defence in front of a 3-member board. They were asked to develop and present their own IBSE activity within the Establish framework. Teachers developed different activities pointing their description, IBSE character, science, pedagogical and industrial content knowledge and assessment tools. They described the learning aims, materials used in the activity, suggestion how to use the activity in the class and possible questions that teacher can ask their students. There were altogether 12 physics, 7 biology and 6 chemistry teachers who successfully completed the course with the

credits award. All the teachers' presentations with the developed activities have been shared by all the teachers for their wider use. The examples of the activities developed for the final defence by physics teachers can be seen in tab. 2.

Name of activity	Level of inquiry
Who was Archimedes (Part I, II) Archimedes principle (Part I, II)	Interactive discussion, guided inquiry Guided inquiry, bounded inquiry
Sound speed	Interactive discussion, demonstration, guided discovery
What is pressure? How to prepare a fountain? Pascal's law and its application	Guided inquiry Guided discovery/ inquiry Guided inquiry
How does electromagnet work?	Guided discovery/ inquiry
Magnet and coil	Guided discovery
Rotating coil	Guided discovery
Primary and secondary circuit	Interactive discussion
Self-induction	Guided discovery/ inquiry
When and how light reflects? light When and how light refracts?	Guided inquiry Guided discovery/ inquiry
Fuel cell car (water molecule) How does microwave oven work?	Guided inquiry Bounded inquiry

Table 2. List of activities and their level of inquiry developed by physics teachers

5. Conclusions and implications

The group of teachers who attended the Establish workshops as well as continued and completed the Innovative methods in science education accredited course went over quite an extensive and in-depth course. They increased their familiarity with the IBSE strategies before they implemented selected activities in their own classrooms. The teachers' feedback on the workshops as well as the responses on the questionnaires answered by students carrying out IBSE activities have been collected and analysed. Furthermore, teachers have successfully developed their own IBSE activities that have been presented as a final defence of the course and all these activities have been exchanged among the science teachers for their wider use.

In service teachers found inquiry teaching a rewarding teaching experience. However even after participating in training workshops, the more detailed analysis of the lessons carried out by science teachers in IBSE mode showed that teachers still lack the necessary skills for consistent application of IBSE methods.

The results of discussions and questionnaires answered by second level students clearly shows their positive attitude to IBSE, they consider the activities interesting, enjoyable and useful and they even expressed a slight positive shift in attitudes towards science lessons. However, there were also many items without any significant changes even after engaging in a series of IBSE activities, e.g. the impact on students view on science and its role in society has not changed, neither has their inclination towards taking up careers in science or technology.

To sum it up we consider several reasons for the achieved results:

- Lack of teachers experience and necessary skills for IBSE application. Some teachers still tend to talk a lot instead of questioning and developing students' inquiry skills and forcing students' independent work. The traditional methods of teaching are deeply rooted in teachers' approaches to students.
- Students experienced just several lessons in IBSE mode. This small number of lesson probably cannot influence dramatically their views of science and science education.
- Teachers got enthusiastic about the IBSE method while being at the course. Returning back to their own school environment with not so supporting atmosphere that teachers experienced very often was rather disappointing and demotivating.

As a result we are persuaded that one of the key points is to offer teachers on-going support:

- In the field of teaching materials and teacher training activities.
- Teachers need not only support from the teacher training institute but they also need help from their colleagues in their home institution who think the same way and provide everyday support in order to enhance collaboration and support from each other.
- Overall positive atmosphere at the school can be highly motivating.

Analysing all the already carried-out activities and the achieved results as well as the above mentioned key points there is a strong effort

needed in order to create groups of educated teachers from the same school who would form a community to have an on-going support not just from the teacher training institute but also from each other. The community of science teachers (physics, chemistry, biology teachers, eventually math and informatics teachers) who are well educated in the field of IBSE and think the same way can systematically change the atmosphere at school towards more open to new methods. Teachers' systematic activities in the classes across several disciplines could also lead to changing atmosphere in the classroom in order to fulfil the goals of the current curriculum.

In order to shift the already well-started process of teacher education and IBSE activities implementation in Slovakia to a higher level we already selected teachers from the same schools where there is at least one already educated teacher. We now continue with teacher training of the science teachers' groups (created by physics, chemistry and biology teachers) from the same school. This will be followed by implementation of IBSE activities across several disciplines so that students experience IBSE in wider extent in several subjects taught by several teachers. We strongly believe that this systematic approach will bring positive results in creating the right atmosphere at schools and the implementation in the classroom brings more positive shift in students' opinions as well and will meet the goals of the current curriculum.

8. Acknowledgements

We thank the partners of the international FP7 project Establish (No. 244749), for the motivation towards promoting the idea of Inquiry based science education. This work is the result of the international 7FP project ESTABLISH (European Union's Seventh Framework Programme FP7/2007-2013 under grant agreement n° 244749).

9. References

- [1] Slovak national curriculum in physics for secondary schools, available on <www.statpedu.sk>
- [2] ESTABLISH project, available on <<http://www.establish-fp7.eu>>
- [3] Kekule M, Žák V. The Establish project and an Assessment of Its Impact on

- Students, proceedings of GIREP 2012 conference, Istanbul, 2012, in press
- [4] Ješková Z, Kireš M, Fazio C, McLoughin E, Kedzeriska E, Žák V, Kekule M. Impact of IBSE methods and IBSE materials on student/teacher learning, proceedings of GIREP 2012 conference, Istanbul, 2012, in press
- [5] Declaration of the Ministry of Education 445/2009 about continues education, credits and attestations of pedagogical and professional staff, available on <www.minedu.sk>



A STUDY OF THE INFLUENCE OF SCIENCE MAGIC INSTRUCTIONS ON PRE- SERVICE SCIENCE TEACHERS' SCIENTIFIC LEARNING MOTIVATION AND CONCEPT APPLICATION

Fu-Yi Shieh¹, Jen-Chin Lin²

¹National Yangming Municipal Junior High School of Taiwan

²Center for General Education, National Kaohsiung Normal University, Taiwan.

lkksfe@ms47.hinet.net¹,
jclin@nknucc.nknu.edu.tw²

Abstract: *This paper aims at design science magic inquiry teaching of physics courses, help us analyse scientific magic into the relevance of physics teaching. Study sample for junior high school students in eight grade two class 35, a class as an treatment group uses the magic of science inquiry teaching and about teaching another class for the control group, since this study series and has a high degree of reliability and validity of the "Physics concept tests" measured before and after testing. Total variable analysis, the treatment group in understanding physical concepts test scores significantly better than the control group ($F=187.3, p=.000$), and highly experimental effects. 74. Studies have shown that properly designed "magic study on the teaching model of Constructivism teaching" courses in addition to enhancing students' understanding of physical concepts of things, can*

attract students' high level of motivation. In addition, the study argued that teachers should be considered for dexterity, magic, the magic itself contains physical concept by the use of suitable teaching strategies of guiding students' learning.

Keywords: science magic, magic science teaching, teaching reflection

Introduction

The study introducing and literature to explore the scientific magic (Science magic) as a should be used to assist students in building a scientific model of inquiry teaching method. However, coordination in two different areas of science and magic are? how do we properly define the traditional differences between magic and science magic? scientific magic how to design appropriate curricula for physical research in the field of teaching it? Scientists will be simplifying complex natural phenomena, exploring history through important who were seeking to influence the underlying causal relationships (Lawson, 1995), resulting in scientific models to explain and predict natural phenomena behind the functioning of mechanisms (Bransford, Brown & Cocking, 2000; Gilbert, 2008; Schwarz, Reiser, Davis, Kenyon, Acher, Fortus, Swartz, Hug & Krajcik, 2009). But, usually natural phenomenon has more items variable due to (multiple variables), and widely, and changeable, and needs long-term exploration, party can found have main variable due to, trait, for country in the or country primary school child,, natural phenomenon behind operation of complex mechanism, and scientists exploration natural phenomenon by construction of science concept or science model is abstract, and stiff, and violation they General of funky (naive) concept and difficult to understanding, such as atomic structure, and pendulum of movement, and free fall, physical concept; While most of the magic created by the amazing performances only encompasses one or two simple concepts or practices might magic from magic itself or skilled technique, although violations of the General popular awareness, magic that is relatively simple to complex natural phenomena of many.

Therefore, this study argued that if you can design simple, relevant scientific research on magic course combines teaching, construction can develop students' scientific models, and for

a preliminary understanding of the meaning and understanding of the scientific model, and cultivating the students' learning motivation of constructing scientific models, taking into account the development of students' cognitive and affective development. Gilbert (2008) as well as Schwarz et al (2009) argue that models should be considered as a tool to explain and predict phenomena of productive, stress the purpose of constructing models of development ideas and test ideas.

Stewart, Cartier, and Passmore (2005) pointed out that the modeling in the classroom, students understand science connotation is that they can make a reasonable claim, and looked forward to the student experience to reflect on their own thinking, reflection of practice involved the students models of interpretation, and can use this model to guide their research capacities, and the ability to understand and participate in the evaluation of the scientific model. To sum up, how to find appropriate magic will convert to science teaching aids, in order to achieve those constructing scientific models, provides students develop their science learning motivation and understanding of science concepts?

The scientific concept is studied and tested

Magic bullet good teaching practices and curriculum instructions magic elastic rods (also known as magic telescopic stick), as a way to screw the magic of plastic injection molding tools, full of highly interesting, novel and contains a physical concept. Magician shows the magic of elastic rod usually "stick out" approach, first volume shrinkage (that is, stored elastic potential energy) hidden in the Palm, elastic bar tab at the top of tongue and pushed the magic, magic bullet bar pop-up (the moment stored elastic potential energy converted to kinetic energy), so as to render "from nothing to a" "flashes" the surprise effect. Except above of magic shows outside, this research development to Magic play Rod as students for research of science model, teaching design as following steps: (1) Yu shows Magic play rod and describes its basic physical concept Hou, introduction between Magic play rod of spiral structure and bevel effort of mechanical principle; (2) will Magic play Rod volume shrink, and press its gravity, and again placed desktop, dang press of hand release, Magic play Rod will to gravity for Center from on both sides while play open; (3) bearing above way, further

will volume shrink of Magic play rod end press live, When you let go, magic bullet stick forward would be created by forcing, hands press the other end in the opposite direction, such as the size of the reaction fig1 "magic elastic rod structure and physical mechanisms" as below.

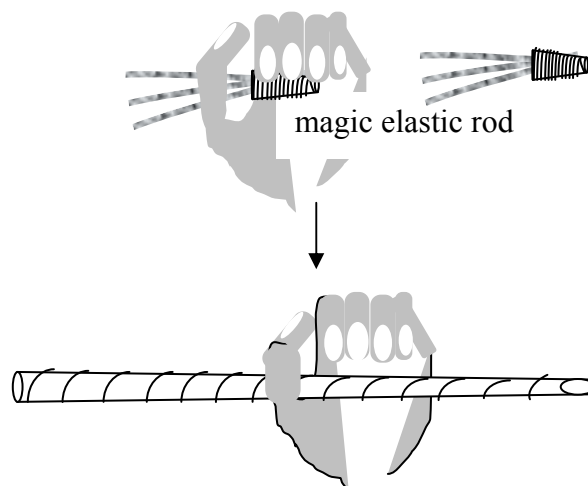

Figure 1. the structure of magic elastic rod and physic mechanism

Based on the above figure 1 "structure and physical mechanism of elastic rod of magic", while teachers with a steady incline of the magic bullet to form the spiral structure of great collections to store elastic potential energy of the elastic rod with the hands, after being let go, play stick immediately convert the stored elastic potential energy to kinetic energy, on either side of the ejection seat. Four, experimental and control groups of cases handled by teaching the teacher and the teaching of scientific inquiry process as described below: 1. teaching is not informed in advance of the control group, the magic of elastic rod structure; whereas the treatment group to express ways of teaching, after school, provide students with further scientific explanations, discussions, exploring its structure and construction of models; 2. teacher presentation and familiar physical concepts of magic elastic rods that contain the following:

- (1) the process of elastic potential energy into kinetic energy;
 - (2) elastic rod with bevel helical structure formed by;
 - (3) the bullet bounced off on either side of the rod to the center of mass.
3. Prompt students to watch teachers model and in a pen and paper to write down or constructing models of explanation and prediction. 4. students write or draw model, model again and explain the implication of the scientific concepts. 5.

elastic rod model construction using magic design provides students learning transfer and application of scientific concepts. This study provides further consideration of the new situation, "magic tape", but magic tape measure with the magic bullet physics concepts similar to the great, full of fun and novelty, "the physical mechanism and structure of magic tape" as shown in Fig2.

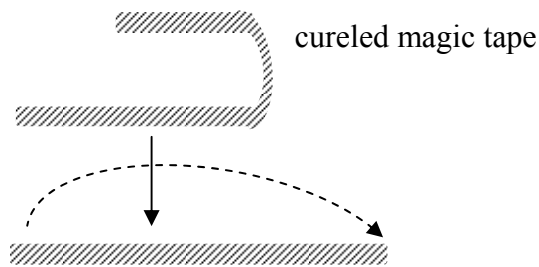
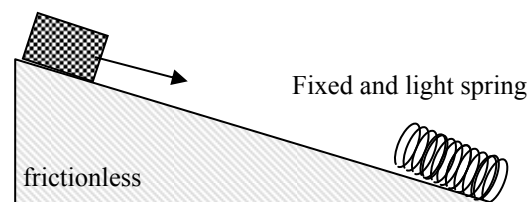

Figure 2. The physical mechanism and structure of magic tape

Research Design

The researcher analyzed the data by SPSS and ANCOVA. For against group students only used shows magic tape measure of metaphor teaching way, purpose is review students is can using teachers tells of physical concept for Science explained; and experiment group students is used express magic tape measure contains of science concept for research teaching, provides students exploration its and magic rod has similar of science concept (such as stretch aspects in conversion into kinetic energy), by this district differentiation metaphor of tells teaching and express of research teaching way, respectively for the control group and treatment group students' understanding of science concepts and impact of constructing scientific models. Five samples, research and research on data processing of the treatment group eight grade regular classes A1 to 35 students (boys and 19 girls 16 people) used magic of science inquiry teaching of physics, and in another regular class A2 to talk about physics teaching control group of 35 people (boys and 20 girls 15 people) for the study sample. Treatment group and the control group teaching time is one month, that is, from the first scientific achievements evaluation (first test) between the end of the second world science learning achievement assessment (second test) period. In the teaching of the above before, twice before engaging in the research and development of high reliability and validity "Physics concept tests" before logging, and "Physics concept tests"

with "simple machines" as the main test content, a total of 10 questions designed to test tools. The test questions in a two-stage test (two-tier test), first asked the students selected answer, again selected by the students fill in the answers on the grounds (Science), optional answers and reasons are correct and match the answer before. For example question 1th 1. "ramp" for the machinery of what features? (a) labor-saving, saving time, the provincial power (b) labor-saving time, no province (c) effort, saving power and, when they do not (d) easily, saving time, saving power. You write the answer, submit your reasons (scientific explanation). First, entitled as aforesaid, if the students fill out the wrong answer (a), (c) or (d), regardless of the reason is correct, no score; and fill in the correct answer is (b), the reasons for errors, no award. For example, Second, as shown in the following illustration, objects from the smooth slope top sliding down "during the compression spring", its energy how to convert? (a) the kinetic energy is converted into gravitational potential energy and elasticity potential energy (b) elastic potential energy into kinetic energy and gravitational potential energy (c) elastic potential energy and kinetic energy converted to gravitational potential energy (d) converting gravitational potential energy to kinetic energy and elasticity potential energy. You write the answer, submit your reasons (scientific explanation).



If the 2nd question, students fill out the wrong answer (a), (b) or (c), regardless of the reason is correct, no score; and fill in the correct answer is (d), but reasons for errors, no award. This quiz after review by two experts on science education, surveying the 246 students, and then take effective samples for reliability analysis of 198, alpha value is .85 as well as scoring two Institute for science education doctoral student, rater reliability. .92, experts said the test materials with high reliability and validity. After teaching, two to both the test after test, previous test results as a global variable, later test results as variables, covariates analysis again, and finally compare

differences between two classes of physics concept tests for significance level.

Quantified data processing, research results and discussion results and discussion based on the research after experimental treatment, treatment group control group A2 and A1 of the simple machines unit tests before and after the test regression coefficients within a group isomorphism testing, $F=3.384$, $p=.07 (>.05)$, meet-isomorphism testing. Two groups of average and standard deviation before and after adjustment, as shown in table 1: table 1 simple machines unit tests before and after the adjustments mean and standard deviation.

Result and discussing

Quantitative study on the data processing results and discussion according to the experimental treatment, treatment group control group A2 and A1 of the simple machines unit tests before and after the test regression coefficients within a group isomorphism testing, $F=3.384$, $p=.07 (>.05)$, meet-isomorphism testing. Two groups of average and standard deviation before and after adjustment, as shown in table 1:

G	num	pre- adjusted average	pre- adjusted standard deviation	adjusted average	adjusted standard deviation
A	35	102.26	21.42	102.40	.79
A ₁	35	87.11	20.09	86.96	.79

Table1. The scores of simple machines test in average and standard deviation

Table 1 shows the adjusted mean for the experimental group than the control group. ANCOVA shown in Table 2.

variation	SS	df	MS	F
covarienc e	27825.9	1	27825.9	
between groups	4177.7	1	4177.7	187.3
errors	1494.6	67	22.3	

*** $p<.001$

Table2. The summary table of covariance analysis of the simple machines test

From table 2 that, $F=187.3$, $p=.000 <.001$, significance level, and the volume of teaching effects(Partial Eta Squared). 74, said after teaching and experiment on the Group's

performance in the simple machines unit tests than a control group with high results. Based on the above analysis of quantitative data in this study show after teaching, the treatment group in the simple machines unit tests, better than the control group and of a significant level.

Therefore, this study uses qualitative data analysis and discussion in order to learn more about experimental study on modeling for the sets of teaching history, resulting in learning science concepts than about the teaching of the control group of causes. II, and mass sexual data analysis and discussion according to this research of research design and classroom observation, against group is not for Science magic of built die research teaching, teachers is to teachers manual for this and according to textbooks content of tells way for teaching, so against group is not for Magic play rod and magic tape measure of research teaching activities, teachers only according to textbooks content describes of stretch aspects in, and bevel, and spiral, simple machinery of concept.

The control group students after the above described method of teaching, teachers model magic elastic rod with magic tape measures with a view to understanding "after the students in the teaching of scientific concepts of metaphor, scientific explanation can be used in magic, or establishment of appropriate scientific models". Researchers found after classroom observation, control group students and what they learn simple mechanical concept could not be applied to these two scientific explanations of scientific magic, for example, when teachers ' questions: "does have magic bullet stick presentation, what the concept of simple machines?" Control group most of the students wrote: "magic elastic rods being curled up, hiding in their hands, then catapulted into a magic wand!"

Teacher expressed the magic of elastic rod with simple machines physics concepts and treatment group students real magic elastic rod with magic tape, ask the students to scientific explanations for the following issues, so as to see if the treatment group of students through explicit teaching, and construct the appropriate scientific models.

1. The magic elastic rod with magic tape of the same or different?
2. Which scientific concepts involved two magic?

Have you ever tried to learn a scientific explanation of the concept note or drawing. On the above, such as the treatment group of small

new instructions, 1th issues, as well as drawing magic elastic rod model of, respectively, as shown in the transcription of the following data:

1. Magic stick is composed of inclined section by section with a spiral structure. However, the measuring tape is coated with the whole length of the flexible steel bar.
2. Elastic rod and tape measures can be compressed, stored potential energy, after you let go, converted into kinetic energy of the ejection seat.

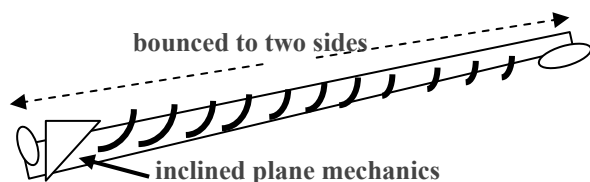

Figure 3. *The magic elastic rod's model*

A₁0325

According to the above transcription data, as shown in Figure 3, an treatment group of small description new magic bullet bar "consisting of beveled section by section. Constitute a helical structure meaning, little new construction, the magic play the great scientific models, bevel and spiral (structure) of rational scientific explanation. In addition, little new has further discovery and description as appropriate, magic elastic-rods and magic tape measure between the two has "elastic potential energy into kinetic energy" of the physical mechanism of the common. Substantially in the treatment group by magic bullet bar modeling for the exploration of the history, are able to draw up a similar scientific model, and "slope" and "Helix" explanations of concepts such as physical mechanism of operation contained in the model. Control group benefit us after teacher demonstrates magic elastic-rods and magic tape measure is described, respectively, as shown in the transcription of the following data: "play sticks and tape measure is just a magic props, bounced off straight after. Magic elastic rods and magic tape is compressed, and play automatically let go. Props for your very special.

A₂0328

Although Buttitta, La Baff and Lundgren (2007), as well as Shalit (1998) point out that "magic is not only magic, also often contain scientific elements. "However, the qualitative data from the above analysis that the use of metaphor about teaching in the control group students and lack of awareness in the magic inherent in scientific

concepts, such as bevel, spiral, the concept of potential energy into kinetic energy, and so may not be able to construct their own models, all in a simple intuitive way to pure magic techniques or considered magic. While the treatment group of students through the express modeling for the exploration of the teaching of scientific concepts, most scientific explanation: "magic elastic rod for a helical structure with beveled to form...", and "magic and magic tape measure elastic rods are stored elastic potential energy, transformed into kinetic energy and magic shows. "Restaurant, and research conclusions and recommends and teaching reflection a, and research conclusions according to this Institute design of science magic research teaching of physical courses, and simple machinery unit quiz results before and after measuring proceeds results of total variable analysis learned that, experiment group in physical concept quiz (simple machinery unit) results of performance Shang over against group, has height of effect volume, displayed science magic research teaching in teaches students learning above physical area of concept understanding Shang over tells type teaching way; The study found students in practical classes, the treatment group than the control group students more active, stimulating curiosity and willingness to ask questions. In addition, the researchers also found that the treatment group of students to this modeling study teaching in the course of surprise to students of the science behind the magic textbook and involve the basic physical concepts (simple machines), such as elastic potential energy converted to kinetic energy, torque, helical or bevel, and concepts such as action and reaction.

Therefore, dang shows same of magic Shi, against group students and cannot to above of physical concept made science explained, most students still thought magic just techniques of performances or magic props hidden organ, also cannot perceived Magic play rod by contains of science model, and operation mechanism and science concept, very and also cannot as treatment group students, sleep known Magic play rod and magic tape measure Zhijian has common of physical concept (simple machinery of principle). II, and research recommends this research according to research of results and discussion made following research recommends, to provides teachers or researchers follow-up to science magic established science model of related teaching research of reference:

1. This research does not further design students for scientific model of understanding of evaluation tools, and science concept of understanding and science model of relationship why? To be development understanding science model of evaluation tools and further analysis, by this in-depth discussion students' cognitive development and its construction model of relationship.

2. This study uses the underlying scientific principles to this magic teaching aids, provide and assist students in exploring and understanding the concept to establish accurate scientific model, treatment group of students are basically the reasonable application of scientific concepts to interpret what they construct models, however, many tricks are.

References

- [1] Bransford JD, Brown AL, Cocking RR. (2000). *How people learn*. Washington, DC: National Academy of Science.
- [2] Buttitta H, La Baff T, Lundgren O. (2007). *It's not magic, it's science!: 50 science tricks that mystify, dazzle & astound*. Lark Books.
- [3] Gardner M. (1997). *Science Magic*. Amazon inc Publishing.
- [4] Gilbert JK. (2008). *Models and Modeling in Science Education*. New York: Springer.
- [5] Lawson AE. (1995). *Science teaching and the development of thinking*. Belmont, CA: Wadsworth Publishing Company.
- [6] Schwarz JA. (2002). *That's the way the cookie crumbles: 62 all commentaries on the fascinating chemistry of everyday life*. ECW Press: Toronto.
- [7] Schwarz C, Reiser B, Davis E, Kenyon L, Acher A, Fortus D, Swartz Y, Hug B, Krajcik J. (2009). Developing a learning progression for scientific modeling: Making scientific modeling accessible and meaningful for learners. *Journal of Research in Science Teaching*, 46, 6, 632-654.
- [8] Shalit N. (1998). *Science magic tricks*. Dover Publications.
- [9] Stewart J, Cartier JL, Passmore CM. (2005). Developing understanding through model-based inquiry. In National Research Council, *How students learn: History, mathematics, and science in the classroom*. Committee on *How People Learn*.

- [10] A Targeted Report for Teachers, Donovan MS and Bransford JD, Editors. Division of Behavioral and Social Sciences and Education. Washington, DC: The National Academies Press, pp.515-565.



CREATIVE HANDS-ON ACTIVITIES WITH WATER, PAPER AND WIRE

Alexander Kazachkov

V. Karazin Kharkiv National University,
Kharkiv, Ukraine
akazachkov@yahoo.com

Abstract. A series of hands-on class experiments and creative projects in Physics and Engineering are presented. Developed for high school and college course of Physics and summer academic programs they were repeatedly practiced and regularly updated based on the students' feedback. Activities require only the most common low-cost materials: tap water, plastic bottles, tea bags, paper, wire, paperclips, and the likes. Although originally designed as the entertaining Physics tricks, all the presented experiments are made strongly instruction-oriented. Related topics include among other, Pressure, Buoyancy, Archimedes Law, Relative Motion, Friction, and Motional Optical Illusions. All the presented activities are open-ended; focused on the counter-intuitive solutions and designs.

Keywords. counter-intuitive phenomena, low-cost hands-on experiments, open-ended creative projects

1. Introduction

Counter-intuitive solutions are especially efficient to develop students' creativity. Some widely or less known low-cost experiments provide for an immediate hands-on application of the students' suggestions. While Physics of the reviewed below phenomena and apparatus is pretty different, they are all united by common creative approaches to their explanation and further development.

2. Cartesian Diver scrutinized

Cartesian Diver, a centuries old Physics toy, remains among the most enjoyable educational apparatus. Moreover, contemporary materials are helpful in avoiding a gross misconception which students easily develop when experimenting with an original Cartesian Diver. Its standard design [1] provides for a small open container (a 'diver') partly filled with air and floating upside-down in the jug of water. A flexible membrane (e.g. a rubber balloon) is stretched over the top of the jug, separating its inside from atmospheric air. Pushing of the membrane *down* with a finger makes a small container dive. Moving the pressing finger *upward* lets the 'diver' rise. Although the only reason of the 'diver's' changed behaviour is the variation of pressure inside the jug, students too often wrongly attribute it to the *direction* of motion of the pressing finger.

Airtightly capped plastic bottles not only make a membrane unnecessary. The way they are squeezed to increase pressured completely eliminates the danger of the above misconception.

2.1. Cartesian 'riser'

Another design variation helps students overcome a common mistake due to inertia of thinking: squeezing of a closed container increases its inner pressure. This is not true 'by default', though. In particular, pressing of an elliptical shampoo bottle along its major semi-axis (arrows in Fig. 1) tends to *increase* its volume thus reducing the pressure. That will make a Cartesian 'diver' *rise* inside the bottle, causing a lot of surprise and questions from the students [2, 3].

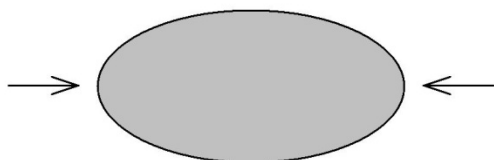

Figure 1. Elliptical container for a Cartesian Diver (section)

Squeezing same bottle along the minor semi-axis sinks the 'diver'.

2.2. Cartesian Diver's surprising dynamics

Creative observation of a highschool student [4] initiated a project to study dynamics of Cartesian Diver's motion. Diver's buoyancy is easily regulated by adding some extra weight, e.g. bits of paperclip wire. Highly buoyant divers are very hard to force down, but when external pressure is released they start up like a rocket. Overweight 'divers' plummet once the bottle is squeezed and rise back slowly and lazily when external pressure is released.

3. Launching a tea-bag rocket or Why is it so cold in the high mountains

Launching a tea-bag 'rocket' is a students' favourite activity, especially when staged as a fiction story. In the story, tea-bag parts are designated as presented in Fig. 2. Their consecutive cutting is explained to be done for the sake of the rocket's cost-saving.

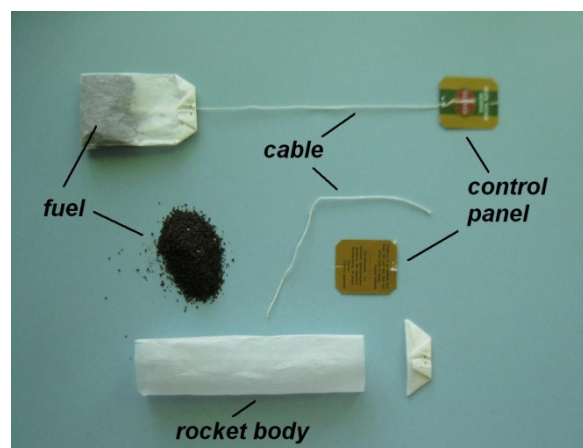

Figure 2. Tea-bag 'rocket's' parts

To launch the 'rocket' its emptied paper body is ignited. Supporting the intrigue up to the very end, the 'rocket' takes off only when burnt to ashes. Flow of rising hot air is not strong enough to move more massive paper bits, Fig 3.



Figure 3. Launching of a tea-bag 'rocket'

The fate of this hot air interested a high school student participating in the summer academic program back in 2005 (Colorado, USA). She wondered 'If hot air always goes up, then why is it so cold here in Rocky Mountains?' To assist the students get an answer some hints on diffusion and other mass/energy exchange mechanisms could be given.

4. Paperclip chaining machine

An amazing trick to connect two paperclips fastening the bends of a S-folded bill (or a piece of strong paper) [5] was developed into an activity very popular among the basic school students. Fig. 4 presents some of their versions of the project performed during the summer-2009 academic program in Pennsylvania (USA). In the written illustrated explanatory reports students addressed their peers in California. Paper clips widely varying in size and shape were used in the activity that culminated in the collective connection of individually produced chains. A resulting enormous paperclip loop was hanged onto the classroom light shades.

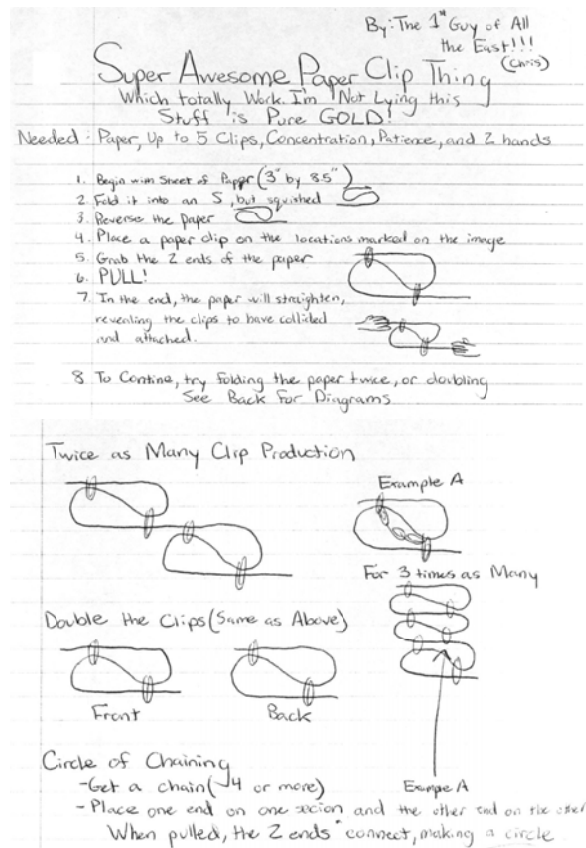
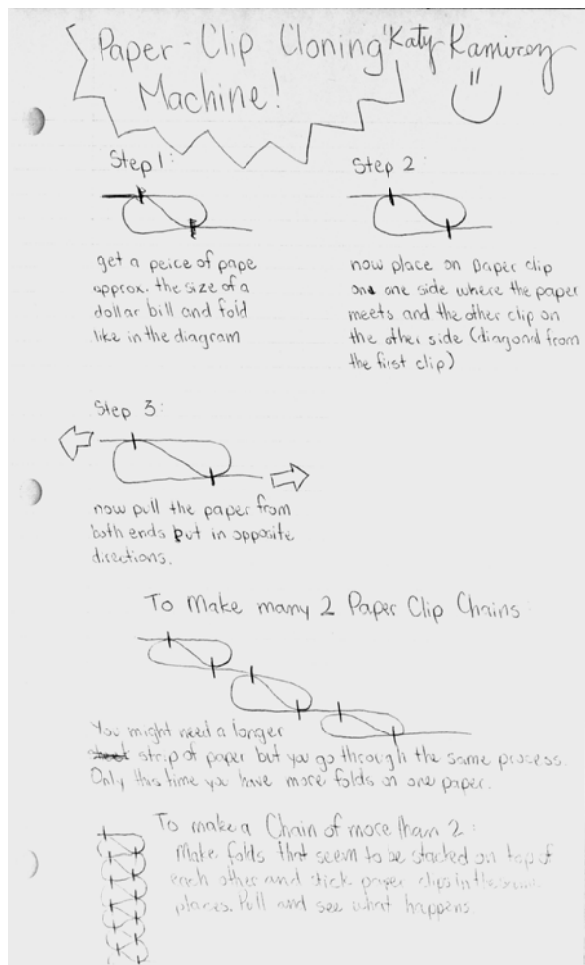

Figure 4. Paper-clip chaining techniques explained in the students' written reports

Possibly the most challenging assignment is to *unchain* two connected paperclips. An incredibly simple and logical solution requires account of the two alternative modes of the clips' connection, Fig. 5.

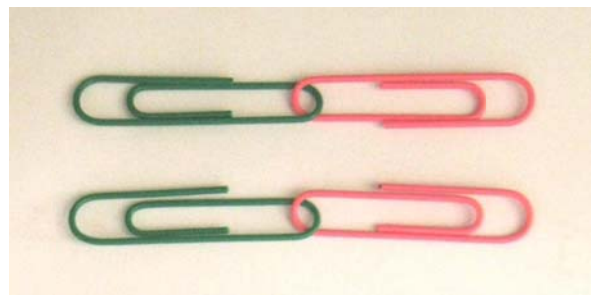

Figure 5. Alternative ways to connect paper-clips

6. 'Endless wire spiral' illusion

A fascinating illusion is generated when two connected wire spirals appear to be untwisting from each other when pulled, but never come apart [6]. The secret that unlikely motion is in the spirals being twisted in opposite directions. Hands-on activities provides for using a single metal strip instead of the separate wire spirals,

alternating the directions of twisting and other creative versions of this apparatus. The most interesting variations undermine students' inertia of thinking by using materials that at a glance seem totally unacceptable (e.g. very soft and rough wire).

7. Acknowledgements

This work is the result of the project implementation: Research and Education at UPJŠ – Heading towards Excellent European Universities, ITMS project code: 26110230056, supported by the Operational Program Education funded by the European Social Fund (ESF).

8. References

- [1] Trowbridge L. Learning Cycle Science Activities for Elementary and Secondary Schools. Greeley, CO: University of Northern Colorado; 2001.
- [2] Kruglak H. The Rising Cartesian Diver. *The Physics Teacher* 1975; 13 (1): 68.
- [3] Fakhruddin H. Cartesian Diver and Riser. *The Physics Teacher* 2003; 41(1): 53.
- [4] Kazachkov A. Buoyancy head over heels: Archimedes Law revis(it)ed. In: Dvorak L and Kudelkova V, editors. *Heureka Workshops 2010*; Praha: Prometheus; 2010
- [5] Moje S. *Paper Clip Science*. New York: Sterling Publishing Co; 1996.
- [6] Magic Wire Illusion <http://www.teachersource.com/product/magic-wire-illusion/light-color> [visited 19-May-2013]



FORENSIC – BIOLOGY WORKSHOP

Tomáš Pinkr¹, Vanda Janštová¹,
Jan Černý²

*Department of Education and Didactics of
Biology¹*

Department of Cell Biology²

*Faculty of Science, Charles University,
Prague*

tomas.pinkr@natur.cuni.cz

vanda.vilimova@natur.cuni.cz

jan.cerny@natur.cuni.cz

Abstract. *Workshops based on forensic biology theme can help to inform the public about the possibilities and limitations of the used methods. The workshop is based on investigation of a fictitious criminal act. During our workshop, you will try some basic techniques of forensic investigation and interpretation of the obtained results. The work is designed to help students understand the principles of the methods and scientific work in general.*

We will use professional equipment as well as cheaper but equivalent one which is sufficient for school practise.

Keywords: forensic science, blood, fingerprints, trichology, proof of saliva.

1. Introduction

Students are influenced by mass media every day and they suffer from an overload of information. The problem is to differentiate between good and credible information (and information source) from the other. Forensic science information isn't an exception. It is presented in crime series as easy and straight forward in contrast to the reality of sometimes time consuming and always care demanding investigation and analysis. [1],[2]. Crime investigators of course have to respect the law and use the correct methods and techniques.

We have prepared this workshop to show more real situation. The participants will try some basic criminal techniques and procedures. This workshop can help them to understand that the crime investigation is more complex than the media show.

The workshop covers following topics:

- A fingerprint identification – participants will obtain an object of interest to collect fingerprints and compare them with the “database”;
- Blood samples – participants will distinguish between stain, blood sample or potential human blood sample and then determine the blood group;
- The proof of saliva in sample – finding out whether it is useful (necessary) to carry on with DNA analysis;
- A forensic trichology – participants will get samples of fibre to recognize its origin (animal hairs, human hair, plant fibre or synthetic fibre).

2. Material

We will use some special instrumentation for this forensic workshop. The participants can choose among sophisticated professional (more expensive) instruments and simple (cheaper) ones not used in professional laboratories. For special analyses like blood sample analysis it is necessary to use professional equipment. The particular equipment used in each part of the workshop is mentioned in the description text. In addition the teacher/lector should have a notebook or a computer and a data projector to present a fictive crime scene.

3. Methods

This workshop lasts 90 minutes; recommended number of students is up to 20. We start with a short motivational presentation which gives the participants the details needed and the tasks. After this first part there are approx. 15 minutes for each theme. The rest of the time is reserved for presentation of results and the evaluation of the whole workshop. Participants work in four groups. Each starts with one theme and after finishing the task they move to the next theme. Methodological description of the themes is written follows.

3.1. Tale

For better motivation, it is appropriate to prepare a brief story about a fictitious crime. Something like murder or the death of unknown reason is advised. For this reason we use PowerPoint presentation with short description and some

photos from “crime scene”. Because of the aims of the workshop, it is necessary to prepare and photograph some suitable properties (bottle for fingerprinting, bloody objects, envelopes and some fibres - see-below).

Fig. 1 and Fig. 2 show some photos from our crime story.

3.2. Fingerprint identification

Students can work individually.

Dactyloscopy is a criminalistics method based on recognition lines at finger pads (papillary ridges) [3]. Fingerprint marks are very common; fingerprints origins, when skin on finger touches the object/pad.

Identification is based on searching similar markers (i.e. shape, position and distance of papillary ridges). Distribution of these marks is unique for each single human being. Figure shows some of basic mark types [4] (Fig. 3).



Figure 1. *Crime scene.*



Figure 2. *Crime scene.*

For this theme students need fingerprint kit – it contains Fibre Brush (the cheaper very soft cosmetic powder brush can be chosen), Standard

Black Powder, Transparent Fingerprint Tape (transparent hard sticky tape can be used), White Backing Cards (can be copied) (see Fig. 4) and Magnifying Glass. It is recommended to have 2-3 fingerprint templates/databases printed on A5 paper (laminated), spirit fix and fingerprints marker identification manual (see Fig. 3).

For this task it is necessary to have fingerprints made by lector in advance. The surface should be smooth (like a tile or glass).

Take a small amount of powder on the brush and apply it on the checked surface. Do gentle movements in one direction only. Stop when the fingerprint(s) is (are) visible.

Now, take a fingerprint foil, put it on the visible fingerprints and wipe it lightly. Remove the foil and transfer it at the fingerprint card. Students have to work carefully not to destroy the fine fingerprint.

In our exercise, we will evaluate printed and enlarged (zoomed) fingerprint which we found to be easier. To make a judgement about a similarity of the fingerprints you have to find at least 10 marks, which are similar (Fig. 3).

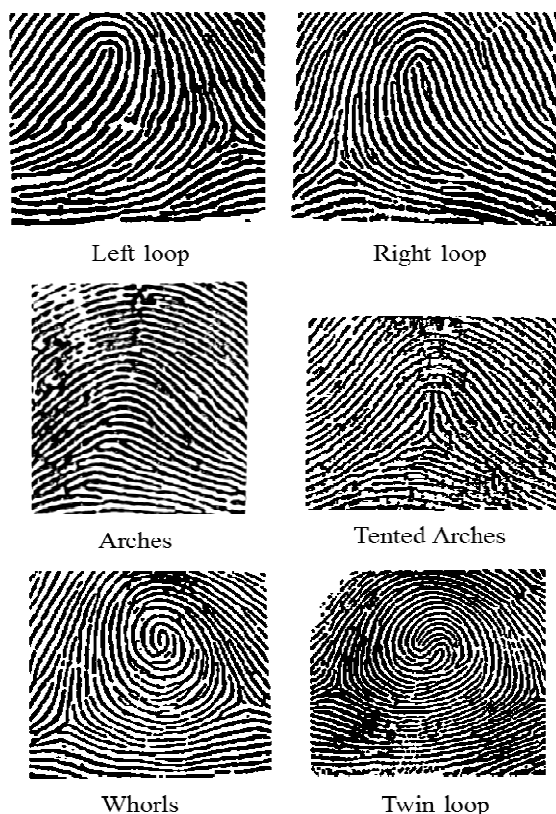

Figure 3. Basic fingerprint mark types [4]

3.3. Blood samples

Students work as a group (if you have time students can work individually or in pairs). In

cheaper and/or faster variation it is possible to only demonstrate the procedure.

Date	Case No.	Print
Victim:		
Address:		
Location of fingerprint:		
Printed by:		

Figure 4. White Backing Card

This task consists of three parts:

- a detection of latent blood sample,
- a specific proof of human blood
- and the determination of AB0 blood group system.

At first it is necessary to prepare sample of human blood and to make it non-infectious and nontoxic. This has to be prepared by medical staff. Put blood sample into a suitable testing tube (e.g. Eppendorf), centrifuge it for 10 minutes at 14 x 103 rpm. Discard the supernatant and resuspend the pelete in formaldehyde. Incubate at room temperature (RT) for 20 minutes. Centrifuge and discard the supernatant, resuspend the pelete in PBS (0.137mM NaCl, 2.7mM KCl, 1.5mM KH₂PO₄, and 4.6mM Na₂HPO₄x12H₂O) and repeat this washing step three times. Resuspend the pelet in 15mM ammonium chloride in PBS and incubate at RT for 5 minutes. Finally, after centrifugation, wash the pelete in PBS and resuspend in final volume of PBS (same as was the volume of the blood at the beginning).

Note that in some countries using of human blood at the schools is illegal. So before starting of experiments it is necessary to study your country law. For example, in Slovakia, human blood can be used only at the medical schools. At the time of submitting this paper there were not known any restriction banning the use of uninfected human blood for education purposes in Czech Republic (the same stands for any law allowing it).

3.3.1. Detection of latent blood sample

For this task we use HemaScein™ set (contain fluorescein pigment fluorescein), UV light source with a wavelength of 415-480 nm, glasses

with orange filter, 1-3% hydrogen peroxide, 3 samples of “blood” (human blood, animal blood and dyed water) and slides.

Apply diluted fluorescein on the object by sprayer, and then spray the same object with 1-3% hydrogen peroxide solution, which activates the reaction. When sprayed stains are illuminated by light of a wavelength 415 – 480 nm fluorescein emits light (fluoresce). Glasses with orange filter are necessary for observation to filter the excitation light.

This method does not require full darkness, but it is advantageous for the best seen results.

Diluted fluorescein prepared “ready for use” is used at this exercise (according to the producer's instructions).

Fluorescein is a pigment used for the detection of latent blood traces. After water addition fluorescein is reduced to fluorescin. Diluted fluorescein is applied on the object by sprayer. Then the same object is sprayed with 1-3% hydrogen peroxide solution, which activates the reaction. HemaScein™ shows you blood samples or objects with iron ions (fluorescein is iron specific). This method isn't human blood specific [5].



Figure 5. SERATEC® test – used. C area is a control area (colour change shows that the chromatography was successful), T area is testing area (colour change shows that the human haemoglobin is present) and sample well are shown (for droplets dropping).

3.3.1. The specific evidence of human blood

The positive reaction(s) from the task above revealed blood samples for performing specific test for human blood identification. Use SERATEC® set for this task.

SERATEC® test is based on membrane chromatography with two areas – one control (C-area) and one test (T-area) (see Fig. 5). SERATEC® is immunological test, originally developed to determine colon carcinoma. In forensic practice it is possible to determine 15yo

dried human blood by this test.

Short manual - collect blood sample and mix it in the “preparing tube”. Drop three droplets in the sample well (see Fig. 5) wait for the liquid to run through and interpret the results (two lines – human blood, line at C – non human, no line or line at T - invalid) [6]. Full manual is attached to the test.

3.3.3. Determination of AB0 blood group system

As the human blood sample was identified, students can determine its AB0 blood group. Use the AB0 determination antibodies, slides, and pipette, a microscope can be useful.

The identification of human blood groups is based on serological test. Human blood cell can but does not have to carry two antigens – A and B. If you have antigen A and antibodies anti-B, your blood group is A, antigen B and antibodies anti-A – blood group B, both antigens and no antibodies – blood group AB and no antigen and both antibodies – blood group 0. If antibody reacts with antigen the clotting is observed and blood group is serologically detected.

Write letters A and B on the slide before testing. Drop two drops of the same blood sample near these numbers. Add a drop of antibodies anti-A resp., anti-B into the blood samples (only one antibody to one blood drop). If the clot/s isn't visible, you can use the microscope for better view. The Table 1 shows the results of the reaction:

anti-A	anti-B	Blood group
+	-	A
-	+	B
+	+	AB
-	-	0

Table 1. Results of antibody reactions
 (+ the clot was made, - the clot wasn't made)

3.4. The proof of human saliva in sample

Commercial and expensive tests for saliva identification in the sample can be used or it is possible to do it cheaply. Let us try the cheaper variant.

Students work in pairs/small groups.

This task has two parts – the first is testing and the second is control. We recommend to start with testing as it is time-consuming. Then students prepare control set. This set should help them with evaluating of the test.

Students need saliva sealed envelope, saliva (students can split it – they will like it); 1% starch solution (dissolve 1g of starch in 100 ml of hot water and stir it - ! for use, solution must be at RT!), iodine solution (Jodisol – iodide disinfection), 2M solution of HCl or vinegar, sodium carbonate, Test-tubes, Test-tubes stand, Pasteur pipette.

3.4.1. Test

Prepare test-tube into the test-tube stand and add cut samples of material (sealed envelope). Add 2 ml of 1% solution of starch, 1 ml of sodium carbonate solution and 2 drops of iodine (Jodisol). Shake it. Incubate 15 minutes in the laboratory temperature or water bath (37°C) and observe the colour and possible colour change. Make notes.

Blue colour appears at any case. Final colour is lightly blue to yellow is saliva is present. If saliva is not present, colour does not change. Explanation is written below.

3.4.2. Control set

The experiment shows enzymatic activity of α -amylase. Amylase (called ptyalin in saliva) splits saccharides and polysaccharides (as starch; at maltose and dextrin). Enzymatic activity is influenced by pH and temperature. Low pH, as well as high temperature decelerates (or stops) enzymatic activity. On the other hand, enzymatic activity is increased by gently alkaline solutions. In this exercise we prove the influence of pH on the activity of ptyalin and we determine saliva in the sample.

Prepare 4 test-tubes and mark them 1-4. Add saliva (1 ml), 1% solution of starch, 2 M solution HCl (or vinegar), concentrated solution of sodium carbonate and distilled water according to the scheme in Table 2.

- Incubate test-tubes at RT for 10 to 15 minutes. Add 1-3 drops of iodine (Jodisol) into the all test-tubes afterwards.
- Results of this experiment are:
- Test-tube 1 - blue (dark blue), blue colour change is due to reaction of starch

and iodine; iodine does not influent breakdown of starch.

- Test-tube 2 - lightly blue (purple). This means that ptyalin in saliva spitted starch.
- Test-tube 3 - lightly yellow. All starch was breakdown by saliva. Sodium carbonate (alkaline solution) accelerated enzymatic activity of amylase.
- Test-tube 4 - blue (dark blue). Starch isn't decomposed and the blue colour is result of the reaction between starch and iodine. It shows that acidic conditions decelerates (or stops) enzymatic activity of amylase.

	Test-tube 1	Test-tube 2	Test-tube 3	Test-tube 4	
Starch	✓	✓	✓	✓	Starch
Saliva	X	✓	✓	✓	Saliva
Distilled water	✓	✓	X	X	Distilled water
vinegar/2M HCl	X	X	✓	X	vinegar/2M HCl
Sodium carbonate	X	X	X	✓	Sodium carbonate

Table 2. Schema attempt: Test tube 1 – add starch and distilled water; test tube 2 – add starch, saliva and distilled water; test tube 3 – add starch, saliva and vinegar; test tube 4 – add starch, saliva and sodium carbonate.

3.5. Forensic trichology

The forensic trichology analysis is very difficult and hair(s) can be analysed from many points of view. This analysis is based on light microscopy. You need human hair and animal hairs (we use dog hairs) for this experiment, one piece of each, a microscope, slides, coverslips and water are also necessary.

Students work individually, everyone has his/her own material.

Hairs are very important traces analysed by forensic trichology [7]. An individual human identification can be executed on hair analysis base. Trichology uses observation as well as genetic analysis. Making conclusions based on observation isn't easy, because everyone has more types of hair (humans as well as animals) [7]. The same hair type could also have different colour (especially if coloured, grey, etc.). Differentiating of human and non-human hair is very important for forensic trichology. We can use hair analysis not only for differentiate human and non-human hair but it can be used for differentiate animals' family, sometimes even race [8]. Most important marker of hair is a pulp

structure, which is characteristic for particular families. Hair structure is shown at Fig. 6. We can use some basic rules to differentiate hair source of animal and human type in general – human hair has thin cuticle and its pulp brightest under a microscope. This is not true for animal hairs (care must be taken with white or blonde hair). Animals' hairs have thicker cuticle.

Students get the hair samples (marked by numbers 1 and 2). For analysis students have to prepare microscopic preparation of hair sample – put the hair sample on the slide in a water drop and cover with a coverslip. They observe the object under the microscope and next try to determine human and animal hairs. Students can draw their observations and after this they are able to tell which sample is human and which is animal (for difference see Fig. 7).

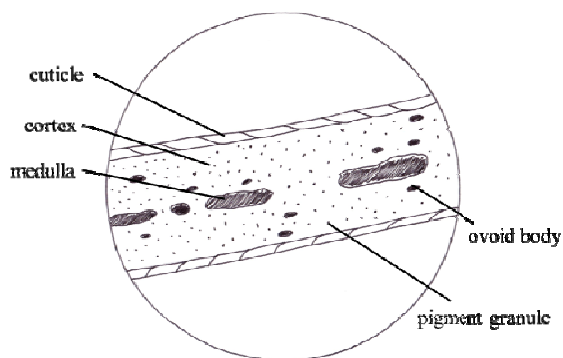

Figure 6. Hair structure [6].

4. Conclusions

The aim is to show students that the forensic sciences are not as straight forward as they may look like.

After attending this workshop they will understand to forensic sciences

Students will learn to work with biological material and they will be able to make conclusions based on the science experiments.

This workshop includes important and interesting topics like blood groups, enzymatic activity of amylase, etc.

5. Acknowledgements

We thank to RNDr. Daniel Vaněk, Ph.D. who helped us to design some experiments (especially the proof of human saliva in sample) and who provided us a discount for the professional equipment.

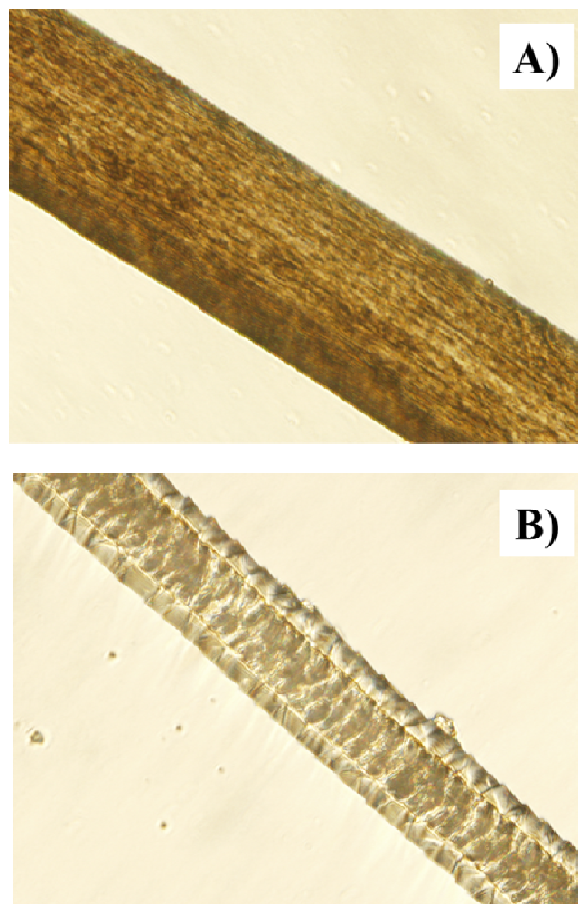

Figure 7. A) Human and B) animal (dog) hair. Light microscope (magnification 400x).

6. References (and Notes)

- [1] Brewer PR, Ley BL. Media Use and Public Perceptions of DNA Evidence. *Science Communication* 2010; 32 (1): 93-117.
- [2] Podlas K. The CSI Effect and Other Forensic Fictions. *Loyola of Los Angeles Entertainment Law Review* 2006; 27 (2): 87-125. Available at: <http://digitalcommons.lmu.edu/elr/vol27/iss2/1>
- [3] Srinivasan VS, Murthy NN. Detection of singular points in fingerprint images. *Pattern Recognition* 1992; 25 (2): 139-153.
- [4] Nagaty KA. Fingerprints classification using artificial neural networks: a combined structural and statistical approach. *Neural Networks* 2001; 14: 1293-1305.
- [5] Barksdale L. HemaScein™ Discovery and Testing for Human Blood. Available at: http://www.abacusdiagnostics.com/Hemascein_1_Sergeant_Larry_Barksdale.pdf
- [6] Misencik A, Laux DL. Validation Study of the Seratec HemDirect Hemoglobin Assay

for the Forensic Identification of Human Blood. MAFS newsletter spring 2007. 18-26. Available at:

https://docs.google.com/viewer?url=http%3A%2F%2Fwww.seratec.com%2Fdocs%2FHEMDirect_Validation_MAFS.pdf

[7] Rowe WF. Biodegradation of Hairs and Fibers. In: Haglund WD., Sorg MH. editor. Forensic Taphonomy: The Postmortem Fate of Human Remains. CRC Press; 1997. p. 337-351.

[8] Deedrick, Koch SL. Microscopy of Hair Part 1: A Practical Guide and Manual for Human Hairs Douglas W. Forensic science communications 2004; 6 (1). Available at: http://www.fbi.gov/about-us/lab/forensic-science-communications/fsc/jan2004/research/2004_01_research01b.htm#id

elements is the use of ICT integrated in IBSE lessons. For this element a variety of support materials has been developed. These materials are organized in a Moodle environment and meant for blended settings, enabling an efficient course with limited life meetings.

Course materials are applied by several partners of Establish in different settings (up to now in Slovak Republic, Italy and The Netherlands). The aims and set-up of course the ICT in IBSE course and first experiences with the courses like learning results of participants based on PhD research will be discussed.

Keywords. IBSE, ICT, Science education, Teacher training

1. ESTABLISH teacher education program

Inquiry-based teaching is an organized and intentional effort on behalf of a teacher to engage students in inquiry-based learning. The goal of inquiry teaching is not solely to transfer scientific knowledge, facts, definitions, and concepts, but rather to enhance students' ability to reason and to become independent learners who are capable of identifying main questions and find relevant answers by a gradually acquisition and expansion of a body of scientific knowledge and abilities. It is a student-centered approach to science learning and a range of types of inquiry activities exist which correspond to the degree of teacher's guidance and student independence involved.

The overall model of the ESTABLISH teacher education program has been designed to accommodate cultural variations among beneficiary countries and to be adaptable to facilitate both the timing of science teacher education workshops and to also cater for the varied experiences of the teacher participants. It is specifically built around the IBSE units that have been developed within the ESTABLISH project and consists of a common core supported by additional materials and resources to address aspects of implementation of IBSE within real classrooms.

Teachers' professional development includes development of both their understanding of IBSE and their ability to develop students' skills in IBSE. The aim of the program is that the teachers develop general skills and competences to implement IBSE and to also be able develop their own materials aligned with the IBSE



PREPARING TEACHERS FOR THE USE OF ICT IN THE FRAMEWORK OF INQUIRY BASED SCIENCE EDUCATION (IBSE) – THE ESTABLISH APPROACH

Ewa Kedzierska¹, Zuzana Ješková²,
Trinh Ba Tran³, Ton Ellermeijer¹,
Marián Kireš²

¹ Foundation CMA, the Netherlands

² Pavol Jozef Šafárik University in Košice,
Slovakia

³ VU University Amsterdam, the Netherlands
ewa@cma-science.nl,

zuzana.jeskova@upjs.sk, b.t.tran@vu.nl,
ton@cma-science.nl, marian.kires@upjs.sk

Abstract. *In this paper we shortly discuss the approach adopted by consortium members of the FP7 ESTABLISH project from across 11 European countries, to address the challenge of implementing IBSE on a wide scale across Europe. The ESTABLISH project's main intention is to develop and deliver Professional Development for as well pre- as in-service training of teachers. Within the project core elements and additional elements have been identified for these trainings. One of these*

framework. The overall structure is shown in Fig. 1.

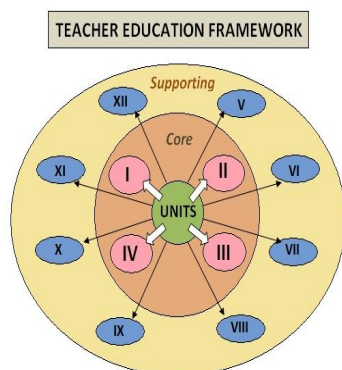

Figure 1. Framework for ESTABLISH Teacher Education

The model involves a core number of elements (four elements) that form the backbone of all ESTABLISH teacher education programs. The core is then supported by a number of other elements (V to XII) that can be implemented as required to suit local teachers, environment, curriculum etc. At the very center of all science teacher education programs are the exemplary inquiry units that have been developed by ESTABLISH. These units will be used as exemplars of good inquiry practices.

Each element is not necessarily of the same extent and duration during implementation. Each element addresses a different topic and forms the basis of background information for some science teachers or can be a component of the science teacher education program in other cases. The length of time devoted to each element is at the discretion of the science teacher education program providers, based on the experiences and background in IBSE of the particular teacher group.

a) A short description of these elements:

I. ESTABLISH view of IBSE – outline ESTABLISH view of inquiry, benefits to learning, role of inquiry in curriculum, provide direct experience of inquiry, ethical issues

II. Industrial Content Knowledge (ICK) – industrial linking – provision of authentic experiences informed by industry or real applications.

III. Science Teacher as Implementer - followed by implementation in classroom.

IV. Science Teacher as Developer – evaluation of classroom experience; identification of further needs.

V. Classroom Management – address issues of developing and managing a student-centred classroom.

VI. ICT – develop confidence and competence in the effective use of ICT in teaching and learning of science and appropriate use in inquiry-based teaching/learning in inquiry.

VII. Argumentation in the classroom – address skills to develop and manage effective argumentation in the classroom.

VIII. Questioning Skills for Inquiry – address the posing of questions that lead to inquiry activities and also to develop skills to ask appropriate questions to guide the inquiry process.

IX. Research and design projects for students – providing authentic experiences – address the development of these ideas, what aspects provide authenticity, student ownership and endorsement.

X. Assessment of IBSE – address assessment of many aspects of inquiry; how assessments can be changed to provide value to the skills (cognitive, affective etc.) linked to IBSE.

XI. Critiquing activities for IBSE – key area to be addressed is to critique activities to identify the areas of inquiry that are connected with particular activities.

XII. Evaluating evidence – address the evidence from scientific experiments to determine the conclusions that can be made from the data, and how these can lead to further investigations.

b) The element VI: The use of ICT in IBSE

For a long time we know ICT might stimulate and enable Science education in a direction that brings (high school) students in a similar position as researchers in science. Within the Establish project the learning environment Coach is used. Coach combines the powerful tools for measurement with sensors, advanced video-analysis up to numerical modelling and facilitates realistic and authentic research projects by students.

Detailed information about the Coach Learning Environment can be found in Heck et al (2009) or in Ellermeijer (2013). Several learning units developed in the framework of Establish do have integrated activities in which the Coach environment and its related hardware (interfaces, sensors) are used.

2. Preparing teachers for the use of ICT in IBSE through a training course

2.1. Course background and boundary conditions

Our project aims to develop a training course for both pre-service and in-service secondary science teachers on the integration of the Coach tools (Figure 2) into IBSE lessons. Participants will not only learn to use the ICT tools to study Physics/Chemistry but also learn to apply them to teach inquiry-based Physics or Chemistry lessons. This is a deep learning process whereas the area of ICT skills and ICT application in IBSE is very large. Participants may face science and ICT conceptual issues of using a particular ICT tool. They may also have to deal with the issue of getting students mainly focused on minds-on science learning and meaning making rather than solving ICT problems. In this process, participants will need not only the ICT facilities but also much time and proper support.

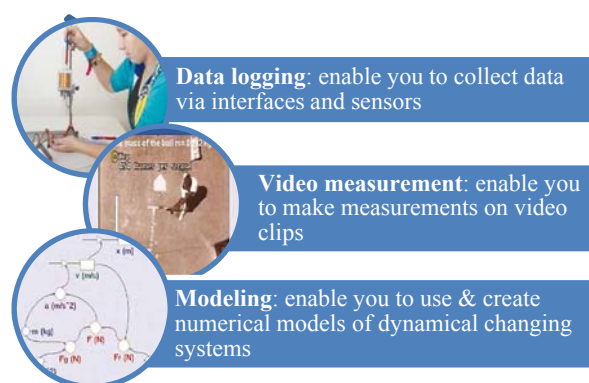

Figure 2. The three ICT tools: data logging, video measurement, and modeling within the Coach learning environment (source: <http://www.cma-science.nl/>)

In the Netherlands, to balance among many courses, teacher education institutes cannot allocate many more credits to the ICT course. It is also hard for teachers and schools to invest much time for intensive in-service courses because of the demanding job in daily school practices. Therefore, to achieve effectiveness of participants' learning on integration of ICT into IBSE, the time constraint should be taken into account.

Data from our studies in context of the Netherlands show that participants of the ICT-IBSE course have considerably different experience, interest, and teaching conditions in

school. Generally, they are teachers of different subjects (physics, chemistry, or biology) with various teaching experience (no teaching experience; few months of teaching as internship; few years of teaching as paid teachers; or many years of teaching as in-service teachers). Especially, some new pre-service teachers left the university 10 – 20 years ago and are now shifting career to teaching. About mastery of the ICT tools, some teachers are quite familiar or moderately familiar, whereas some others have no experience with data logging, video measurement, or modeling. Familiarity with particular tools is also different: more to data logging, less to video measurement and modeling. Additionally, some participants' schools have sufficient software, sensors, interfaces, computers, etc. for learning and tryout of ICT in IBSE, but some others do not have sufficient ICT facilities. Participants teach at various levels of students, first or last years of HAVO (high) or VWO (medium), so possibilities and demand for application of the ICT tools in class are different as well. In brief, participants turn out to have heterogeneous backgrounds, so this boundary condition should be taken into account in designing the ICT-IBSE course.

2.2. Principles underlying the course design

2.2.1. Design principle 1 about a complete cycle of designing, executing, and evaluating an ICT-IBSE lesson

Literature on effectiveness of PD shows that traditional training course will only be effective when supplemented by expert or peer coaching and other school-based activities (Fullan, 2007). According to Joyce and Showers (2002), effective training generally includes an exploration of theory, demonstrations or modeling of skills, simulated practice, feedback about performance, and coaching in the workplace. Changes in teachers' attitude, the transfer of training, and the appropriate, consistent use of new strategies in the classroom should be considered as well. Moreover, hands-on practice is more critical than theory and demonstration in a technology-based training course (Thurston et al., 1997). It is essential to create the proper conditions for teachers personally to prepare work plans and teaching

materials for their students (Borghi et al., 2003). Applying ICT as lab tools in IBSE, science teachers may face fundamental, practical issues related to laboratory in science education. In a review of decades of laboratory use in science education, Hofstein and Lunetta (2004) reported that many activities in laboratory guides continue to offer “cook-book” lists of tasks for students to follow ritualistically. They do not engage students in thinking about the larger purposes of their investigation and of the sequence of tasks they need to pursue to achieve those ends. Students often perceive that the principal purpose for a laboratory investigation is either following instructions or getting the right answer. Students often do not connect the experiment with what they have done earlier. Therefore, teachers need to devote a greater proportion of the lesson time to helping students use ideas associated with the phenomenon they have produced rather than seeing the successful production of the phenomenon as an end in itself (Abrahams & Millar, 2008). Additionally, Marx et al. (1998) argued that science teachers often have difficulty helping students ask thoughtful questions, design investigations, and draw conclusions from data. It should be a priority for participants to go through at least one complete cycle of designing, executing, and evaluating an ICT-IBSE lesson. This provides a condition for hands-on practice and classroom experiences for participants with all aspects of integration of ICT into IBSE. It also creates opportunities for participants to recognize and deal with the issue of cookbook vs. inquiry use of the ICT tools or science and ICT issues in using a particular tool (modeling, video measurement, or data logging) in class. Through this cycle, participants may be more able to analyze factors of the ICT integration in IBSE, so getting more motivation to apply the ICT tools in science teaching in an innovative manner.

All in all, because of boundary conditions of the course and above arguments from literature, we define a principle underlying the course design that: *If you want to develop an effective training course for science teachers to master integration of ICT into IBSE, then you are best advised to make proper conditions during the course for participants to try out classroom activities through a complete cycle of designing, executing, and evaluating an ICT-IBSE lesson.*

2.2.2. Design principle 2 about awareness of possibilities of the ICT tool and a focus on deeply learning only one tool by choice

Training courses typically include large group presentations and discussions, workshops, seminars, colloquia, demonstrations, role-playing, simulation, and microteaching that share large-scale ideas and expertise among teachers and teacher trainers (Guskey, 2000). Through the training course, it is possible for participants to achieve awareness of possibilities of the ICT tools in science teaching, which is the first level of learning on integration of ICT into IBSE. This awareness will bring the motivation of the participants to learn further on their own beyond the course. In the time constraint condition of the course, participants cannot learn all the ICT tools deeply. However the awareness of possibilities will help them to choose a first priority tool that they really desire or need to learn.

With only one tool by choice, a participant will have more time to achieve real mastery of the particular tool in both TCK and TPCK aspects. Furthermore, the three ICT tools, taught in the course, are integrated in the same computer environment, Coach. As a feature of Coach, a user, who has experience with one tool, can learn other tools easier and faster. Hence, once the participant specializes in one of the Coach tools, the perspective of using Coach makes it possible that later, based on experience of deeply learning in one tool, she/he can learn and apply other tools on her/his own.

In brief, because of boundary conditions of the course and the features of the computer environment, we define another principle underlying the course design that:

If you want to develop an effective training course for science teachers to master integration of ICT into IBSE, then you are best advised to make proper conditions during the course for participants to become aware of possibilities of the ICT tools in science teaching and to focus on learning and applying only one tool by choice.

2.2.3. Design principle 3 about a blended setting including training sessions, in-between tasks, and an online platform

Many researchers argue that just training in an isolated event is not effective. A shortcoming of training is that it offers few opportunities for choice or individualization,

so it may not be appropriate for varied levels of teachers' skills and expertise (Guskey, 2000). Moreover, the application of skills is much higher when professional development includes theory, demonstration, practice with feedback, and peer coaching with follow-up (Joyce & Showers, 2002). Thus, in order for participants to retain and apply new strategies, skills, and concepts, they must receive coaching while applying what they are learning. Training sessions, therefore, also must be extended, appropriately spaced, or supplemented with additional follow-up activities to provide the feedback and coaching necessary for the successful implementation of new ideas (Guskey, 2000).

The blended setting that emphasizes in-between tasks with supporting materials (besides training sessions) may suit to the boundary conditions of the course. It may be appropriate for considerable differences of participants' experience, ICT expertise, and teaching conditions in schools. Although following the same learning scenario, participants will go in different directions by flexible options of learning contents, pace, materials, and time with which they feel most convenient, confident, and effective. However, a crucial issue is how to keep participants on task while participants will mostly work in distance learning mode. In this case, participants need an online platform where they can access various supporting materials and receive timely feedback and coaching from teacher trainers.

In conclusion, because of boundary conditions of the course and above arguments from literature, we define another principle underlying the course design that: If you want to develop an effective training course for science teachers to master integration of ICT into IBSE, then *you are best advised to support participants' learning through a blended setting including the course sessions, in-between tasks, and an online platform with supporting materials and with close supervision.*

2.2.4. Course design

The training course design is a proposal for implementation of the design principles. The right part of Figure 3 shows the proposed

training process that includes sequences of training sessions (in contact time) and in-between tasks (out of contact time). The left part presents proposed participants' learning scenario that matches with the training.

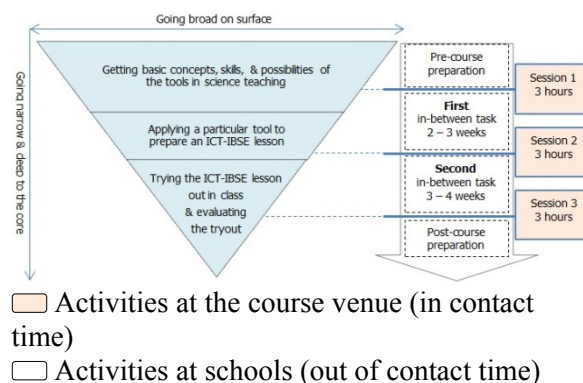

Figure 3. Participants' learning scenario

Participants firstly get an overview of the ICT tools for IBSE (going broad on surface). Then they will personally choose which particular tool they want to learn and apply in classroom as a part of IBSE (going narrow & deep to the core). Participants are expected to fulfill the learning scenario with proposed main activities shown in Table 1. For this learning scenario, the time for in-between tasks is broadened for participants to be able to work with their own competence, experience, and interest flexibly. However, working on their own is the hardest time for participants because of distractions and difficulties. Therefore, we offer supporting materials and timely help via a Moodle platform.

Training process	Main activities
Session 1	Getting basic concepts, skills, and possibilities of the ICT tools in science teaching (Fig. 4a)
1 st in-between task	Practicing only one tool (data logging, video measurement, or modeling) to get the advanced skills
Session 2	With the chosen tool, preparing an ICT-IBSE lesson plan and a related ICT activity (Fig. 4b)
2 nd in-between task	Trying out the ICT-IBSE lesson in class (Fig. 4c)
Session 3	Presenting and evaluating the ICT-IBSE tryout (Fig. 4d)

Table 2. Main activities during the course that links to the figure 3



Figure 4. Pictures of some participants' activities during the course

2.2.5. Supporting materials

On the course Moodle (<http://ibse.establish-fp7.eu/>), participants can find materials to use for training sessions or for in-between tasks. Via Moodle forum, participants ask questions to teacher trainers as well.

To create awareness of possibilities of the ICT tools in science teaching, we provide introductory PowerPoint presentations that give an overview of the tools, background articles from literature, and short video on introduction to Coach. For learning to use a particular tool, participants are advised to practice with the given Coach activities accompanied by video tutorials (*.avi) and written instructions (*.doc) (Figure 5). The Coach activities are divided into three categories:

- Coach basic activities are ready-to-use activities, which introduce simple manipulation and elementary concepts related to a certain tool.
- Coach tutorial activities help to improve skills and conceptual knowledge related to a certain tool through step - by - step instructions.
- Coach subject activities are ready-to-use activities, which serve as a source of ideas or as a resource for further development. These activities can be used to teach a particular subject concept.

For learning to apply a particular tool in the classroom, participants are provided the references on basis of IBSE, instructional forms to design and evaluate ICT-IBSE lesson plans, and resources on sample ICT-IBSE activities on the course Moodle.

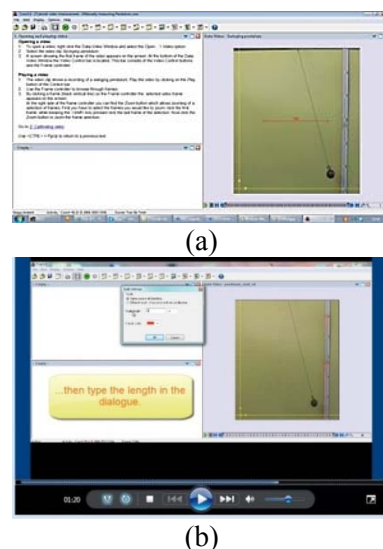

Figure 5. Coach activities (a) and video tutorials (b) on how to manipulate Coach activities

3. Participants' learning through the ICT-IBSE course

3.1. Assessment questions and instruments

The main research questions: For a teacher training course on integration of ICT into IBSE of which design is based on three principles about a complete cycle of designing, executing, and evaluating an ICT-IBSE lesson; about awareness of possibilities of the ICT tools and a focus on deeply learning only one tool by choice; and about a blended setting including training sessions, in-between tasks, and an online platform,

1. To what extent is the course implemented as intended? What are the obstacles in its implementation?
2. To what extent does the course have the effects as expected? What are the reasons for not realized effects?

To answer the research questions, based on the defined principles, we elaborate the course design, and then execute the course in case studies through iterative cycles. We formulate detailed assessment questions as subordinate research questions for data collection on participants' learning process and outcomes. Effectiveness and faithful implementation will be evaluated through each case study in parallel with the optimization process of the course design (Figure 6) during the cyclic research phase.

A set of assessment instruments includes four main categories:

- I. *Questionnaires*: Pre-course questionnaire, Post-course questionnaire, Follow-up questionnaire
- II. *Observation*: Observation of course sessions by the researcher, Observation of course sessions by the teacher trainers, Observation of classroom tryouts
- III. *Documents*: The 1st task report with the Coach result files; The 2nd task reports: an ICT-IBSE lesson plan, a Coach activity, a classroom video, and a tryout evaluation; Students' learning products; Emails among participants and teacher trainers
- IV. *Interviews*: Interview to participants, Interview to teacher trainers

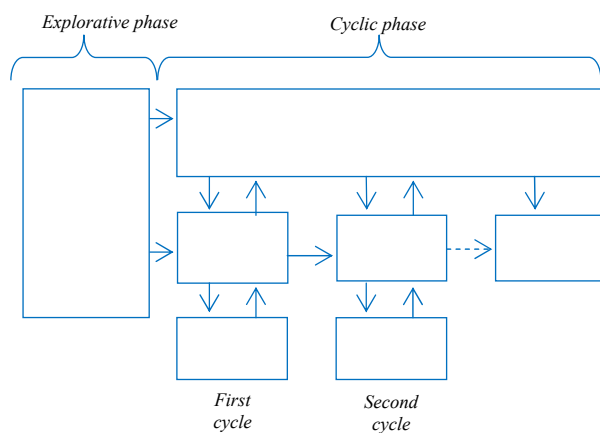

Figure 6. The optimization process of the course general through case studies (adjusted from Knippels, 2002)

3.2 Participants' learning process and outcomes

In this paper, we present some of the data from a case study in context of an ICT-IBSE course for 12 pre-service physics, chemistry teachers from VU University Amsterdam and Utrecht University, The Netherlands.

Participants spent about 2 hours for pre-course preparation, 3.5 hours and 7 hours for the first and second tasks. That 12.5 hours in total for learning in distance compares are more than 9 hours for contact time is reasonable good. We defined some factors (Table 3) that influence the participant's distance learning. Three most influential ones are about awareness of benefits of performing the tasks; sufficient learning conditions such as time, equipment, and school supports; and timely help from teacher trainers. All participants proved that they are able to design a lesson plan for application of ICT tools in inquiry manner. 11/12 participants

accomplished tryouts in schools. In other words, they went through a complete cycle of designing, executing, and evaluating an ICT-IBSE lesson. The course sessions went quite well, but participants desired more time for hands-on activities (Fig. 7) such as in-group learning of basic skills with particular tools (in first session) and in-group preparation of a Coach activity and an IBSE lesson (in second session).

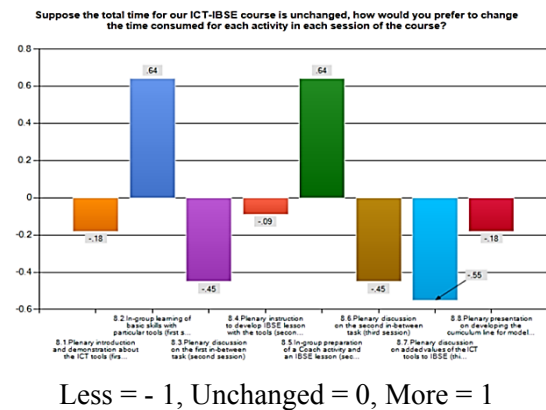

Figure 7. How participants prefer to change the time consumed for each activity in each session

Participants' familiarity with the Coach tools increased reasonably through the course (Figure). A few participants gained advanced level of using ICT tools as they developed their own, new Coach activities with little or no support from the teacher trainers. The ways participants applied the ICT tools in inquiry-based science teaching were quite different. Depended on ICT facility, the teaching agenda, the topic of ICT-IBSE lesson, the level of students, etc., participants could try out in context of a school project, a whole class, or a small group following different types of IBSE such as interactive demonstration, guided inquiry, or open inquiry. With experience and success of learning to use and apply a Coach tool during the course, most of the participants are confident to learn and apply other tools on their own (Figure).

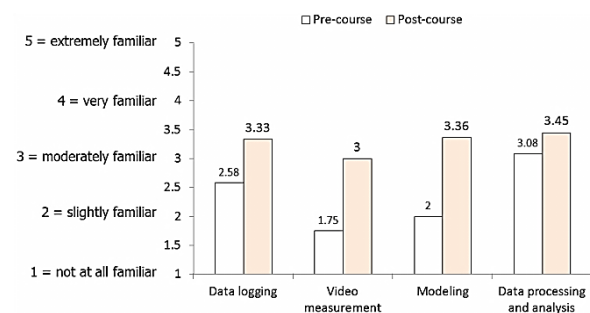

Figure 8. Participants' familiarity with the ICT

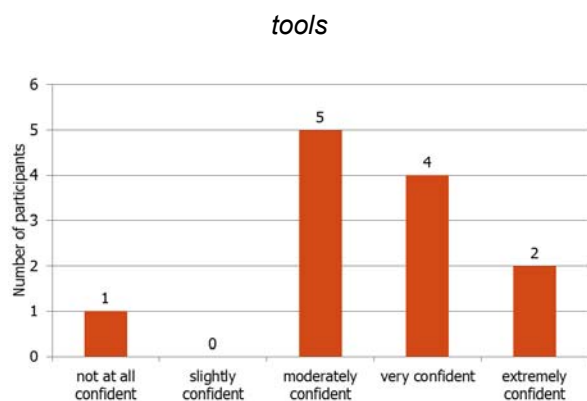

Figure 9. How confident participants are in learning & using the other tool(s) which they did not study during the course

Factors	Rating
Your awareness of benefits of performing the tasks	3.83
Sufficient learning conditions such as time, equipment, and school supports	3.67
Timely helps from teacher trainers when you encounter difficulties, and then ask them	3.5
Emails somehow reminding you about the task	3.42
The requirement that you must present your task results in the meetings	3.33
Obvious task descriptions including clear deadline	3.18
The convenient online platform where you can find solutions for your problems by yourself	2.5

1 = not at all influential, 2 = slightly influential, 3 = moderately influential, 4 = very influential, 5 = extremely influential

Table 3. Factors influence the participant's distance learning

4. Conclusion

The first try-outs with the course showed us it is possible within a limited time to bring teacher-students to a reasonable level of competences regarding the use of ICT in their IBSE-lessons. The blended set-up seems to contribute to this result, under the condition students really spent considerable time outside the meetings.

Already the course is trialed for an in-service course in Kosice, Slovak Republic. Other case studies are planned in Palermo and Hanoi, and further rounds of development are planned based also on trials in The Netherlands.

Final conclusions on the effects of the course will be based on long-term effect measurements:

will the teachers be able to learn the other tools on themselves, how strong do they really implement ICT in their lessons. These results will be published in coming years.

5. References

- [1] Abrahams I, Millar R. Does Practical Work Really Work? A study of the effectiveness of practical work as a teaching and learning method in school science. *International Journal of Science Education* 2008; 30(14): 1945-1969.
- [2] Borghi L, Ambrosio A, Mascheretti P. Developing relevant teaching strategies during in-service training. *Physics Education* 2003; 38(1): 41-46.
- [3] Ellermeijer T. The Use of ICT in the Framework of Inquiry Based Science Education (IBSE). *Proceedings of HSCI 2013*. Košice: Pavol Jozef Šafárik University in Košice; 2013. (in press).
- [4] Fullan MG. *The new meaning of educational change* (4th ed.). New York: Teachers College Press; 2007.
- [5] Guskey TR. *Evaluating professional development*. Thousand Oaks, CA: Corwin Press; 2000.
- [6] Heck A, Kedzierska E, Ellermeijer T. Design and implementation of an integrated computer working environment for doing mathematics and science. *Journal of Computers in Mathematics and Science Teaching* 2009; 28 (2): 147-161.
- [7] Hofstein A, Lunetta VN. The laboratory in science education: foundation for the 21st century. *Science Education* 2004; 88: 28-54.
- [8] Joyce B, Showers B. *Student achievement through staff development* (3rd ed.). Alexandria, VA: Association for Supervision and Curriculum Development; 2002.
- [9] Knippels MCPJ. *Coping with the abstract and complex nature of genetics in biology education: The yo-yo learning and teaching strategy*. PhD dissertation in University of Utrecht; 2002.
- [10] Marx RW, Freeman JG, Krajcik JS, Blumenfeld PC. Professional development of science teachers. In B. J. Fraser & K. G. Tobin (Eds.), *International handbook of science education* (pp. 667-680). Dordrecht: Kluwer; 1998.

- [11] Thurston CO, Secaras ED, Levin JA. Teaching teleapprenticeships: An innovative model for integrating technology into teacher education. *Journal of Research on Computing in Education* 1997; 29(4): 385-391.



LEARNING SCIENCE PROCESS SKILLS VIA CPD DESIGN MODULE

Katarina Kotulakova

Trnava University, Trnava, Slovakia

Katarina.kotulakova@truni.sk

Abstract. *Inductive approach to a science content is a prerequisite to a critical way of thinking and scientific literacy. It is important not only to understand the basic science concepts but it is also essential to learn how to acquire them so they become useful in one's life.*

A set of interconnected inquiry based activities from the field of biochemistry for pupils at lower secondary level (ISCED 2) is presented. Activities dealing with invisible world of microorganism offer opportunities to practice science process skills through number of stimulating situations.

The series was developed as a part of continual professional development training for in-service science teachers.

Keywords. Science process skills, critical thinking, scientific literacy, inductive way of teaching, microorganisms.

1. Introduction

Instructions leading toward a critical way of thinking and a scientific literacy are the key goals in today (not only) science education. It is important not only to understand the basic science concepts but it is essential to learn how to identify the evidence which supports or declines an explanation (theory) and by doing so to make the relationship between the evidence and an explanation. Theoretical knowledge is to be connected with the real world, it is supposed to explain phenomenon and also to provide a useful tool for manipulating and controlling it.

Those skills are important features of scientific literacy [1], [2]. That way an understanding becomes useful in one's life. Inquiry based approach to a science content offers an organized plan for gathering, organizing, and communicating information by pupils. By using scientific methods it solves a problem or leads to better understanding of observed event. The approach puts a pupil in a charge of his / her own learning and searching for understanding.

2. Science process skills

The science process skills enable to sort out and describe studied objects or phenomena (the basic process skill), to test stated predictions, analyse and make conclusions (integrated science process skills). They allow students to conceptualize a question and then seek possible explanations that respond to posed question. In everyday life they are skills which help us to solve problems, communicate about them, and think in a logical manner. Science process skills acquired by pupils are understood as comprehending ways, methods and procedures how to reach an explanation to the problem supported with evidence and arguments. They represent understanding how science works [3], [4].

Essential feature of an inquiry is an ability to identify and pose questions that can be answered through scientific investigation, and propose preliminary explanations or hypotheses based on one's previous knowledge, experience or observation.

- *What caused food to get spoilt?*
- *When / How can we see microorganisms?*
- *How can we preserve food?*
 - *What is essential ingredient(s) which activates yeast?*
- *What makes dough rise?*

Observing the object or phenomenon provides information for further investigation. Inferring about a subject or an event is making a statement or "educated guess" based on previous observation. It is proposing of a possible explanation which is tested in further investigation. The ability to conduct an investigation requires from pupils to keep everything in the setting constant while changing a single variable. This ability provides a powerful general strategy for solving many problems encountered in everyday life. Information or data is gathered and recorded by using an appropriate tools and techniques. Data

are analysed and interpreted. They are to be set in context when results are communicated and the answer to the initial question is given and explained.

3. Continual professional development

The presented series of inquiry sessions was developed as a part of continual professional development (CPD) training for in-service science teachers. It aims to illustrate and teach in-service teachers skills they did not have chance to master during their study themselves and also to present the way how to transform deductive transmissive way of teaching into inductive stimulating lessons where pupils are forced to be active and to think. It offers an example of teaching certain content and leads through the process of forming a concept. Teachers learn to adapt the role of the ones who stimulate or model the investigable situations, who are in the position of those who might just suggest strategies, who coach and scaffold learner's inquiry. The module is supposed also to help them to structure their lessons around "big ideas" rather than around the facts and formulas that they many times see as central in the respective discipline. It aims to help teachers think about how their students come to understand important science concepts through inquiry, what helps them in developing the specific skills and what learning experiences can achieve.

4. Module: Microorganisms

Inquiry based activities dealing with invisible world of microorganism offer opportunities to practice science process skills through number of stimulating situations on ISCED 2 level. Students observe, classify, infer, need to take data, they are asked to predict and communicate their findings in clear representations in form of graphs, charts, description etc. In structured, guided and open activities, the essential structure of experimenting is introduced [5] [6]. It varies in the amount of detailed guidance that the teacher provides. Every inquiry session in the module engages pupils in scientifically oriented questions. However, in some inquiries pupils pose the initial question; in others they choose alternatives or alter the initial question; and in others the pupils are provided the question. Pupils learn to identify variables and control them, to operationalize (stating how or what to

measure as a variable in an experiment), to state hypothesis and propose the way how to conduct the experiment in order to test hypothesis once stated. After confronting findings with other teams working on the same problem they draw conclusions from collected data.

Module develops a concept of how metabolic activity of microorganisms influence people's life and environment we live in. It is based on pupils' experience with noticeable outcomes of their activity and their beliefs. Structure of the module works with ideas pupils bring into the classroom, it gives the opportunity to justify or to refute them. Pupils' personal understanding of certain phenomenon is many times limited to few conditions. Therefore we try to bring new factors in, the ones a pupil does not have any experience with or did not pose certain questions.

Pupils work in teams providing this way a collaborative learning environment. They are responsible for learning in groups, for presenting their finding to the whole class and making conclusions in discussion with all groups in the classroom.

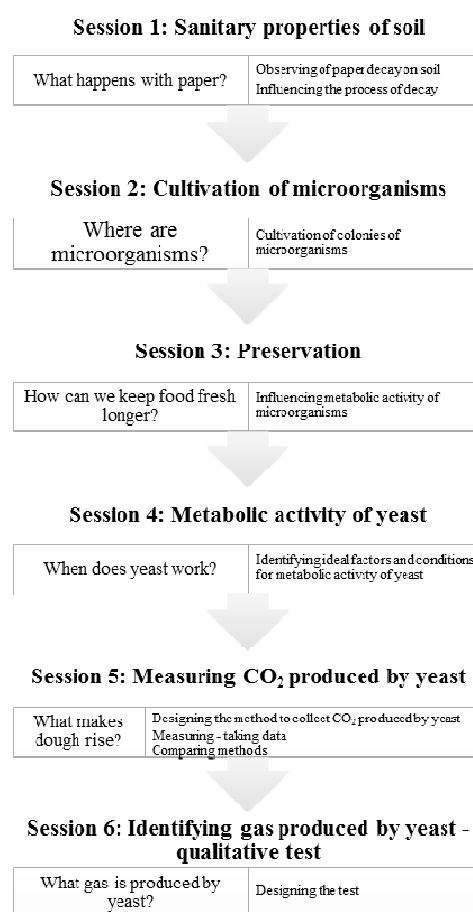

Figure. 1 Structure of the module *MICROORGANISMS* with its teaching units

4.1. Common misconceptions

Personal beliefs represent a certainty in reality where children find themselves and significantly influence what they notice, what they take into account and how they interpret phenomena around them. This also significantly affects their abilities to remember, reason, solve problems, and acquire new scientific knowledge. Pupils can even use proper expressions while they talk or write but they might represent a varied content and therefore also a meaning for many of them is different. Obviously, such a scenario leads to a lot of misunderstandings, possibly to new misconceptions or to a new parallel version of a concept, parallel to a previously owned one by a student. It is therefore essential to get familiar with pupils' knowledge structure about studied phenomenon. Knowing about a content of personal theories teacher can draw students' attention to an evidence which interacts with their prior beliefs and by doing so eliminate selectiveness in students' perception [7] [8].

Findings in our research about the topic show a wide scale of conceptions pupils of a particular grades (ISCED 2) have [9]. When studying organic decay, pupils' experience varied from not identifying decay at all, e.g. paper (after several weeks in soil) gets dirty, wet etc., through identifying soil or nature as agents causing paper to be destroyed or decayed, finally to pointing out to microorganisms in soil as organisms responsible for decay.

Microorganisms were identified as very small, invisible animals, observable only under a microscope. Pupils described them as balls with tails or chains present in dirt, on hands, in air, everywhere around us. They identified useful bacteria in soil and fermentation process and harmful ones causing illness. No further details were provided. It was also obvious that knowledge pupils have has a very particular personal structure. A pupil placed microorganisms into soil but after asking about paper decay the same girl described paper after certain time in soil only as dirty. Metabolic activity expressed by usefulness or harmfulness of microorganisms had mostly no specific or very limited conceptions among pupils. They connected yeast or germs with certain environment (soil, human body, dirt, yogurt, etc.) or activity (fermentation) but were unable to be more specific about it.

As mentioned above, many contradictions in pupils' conceptions were identified. Their

personal experience was not enriched or modified by "terms" they perhaps learnt at school. When one is familiar with students' knowledge it enables him to prepare a stimulating situation or ask questions which interact directly with pupils' prior understanding of a studied phenomenon [10]. It avoids introducing a new term or a concept which does not fit into particular conceptual map of a pupil.

4.2. Background

Soil is a primary environment of microorganisms, they form an essential part of soil edaphon. The key role play bacteria, fungi and algae (microcenosis). Heterotrophic bacteria together with fungi are reducers, they decay organic material. Especially fungi are characteristic by their fast growing mycelium and very intensive metabolic activity. The most common genus of bacteria in soil are Nitrobacter, Rhyobium, Clostridium, etc. Frequently found genus of fungi in soil are Penicillium, Aspergillus, Fusarium, Trichoderma, Mucor, etc. In the first session pupil observe the process of decaying of a sheet of paper on soil. The first indications of decaying process of a very thin sheet of paper is observable already in one week when pupils see yellow spots and paper starts to get perforated.

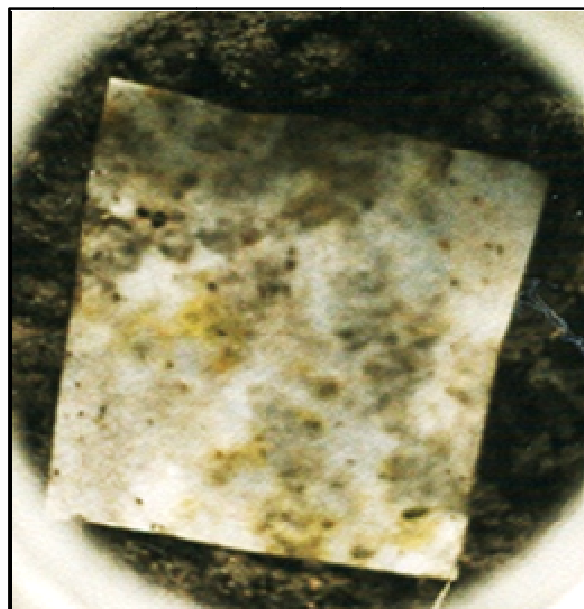

Figure 2. Sheet of paper on soil after 1 week

The satisfactory results can be observable after three or four weeks when pupils do not notice any remains of paper on soil.



Figure 3. *Decaying process of paper on soil after 3 week*

In order to notice and study microorganisms directly, not only through their metabolic activity, they are grown (cultivated) on a very specific types of soils. They grow and multiply if they have enough nutrients. The most bacteria require neutral or slightly basic soil where the source of carbon and nitrogen is found in degraded proteins. In a simple school classrooms or laboratories soils containing sugar and meat broth for growing mostly fungi were prepared. They prefer slightly acidic environment with sugar as a source of carbon. Also conditions (temperature, humidity, pH, etc.) can vary in a wider range. The most typical genus growing on such simple soils are Scopulariopsis, Penicillium, Cladosporium, Aspergillus, Fusarium, Mucor, Epicoccum, Alternaria and Phialophora.

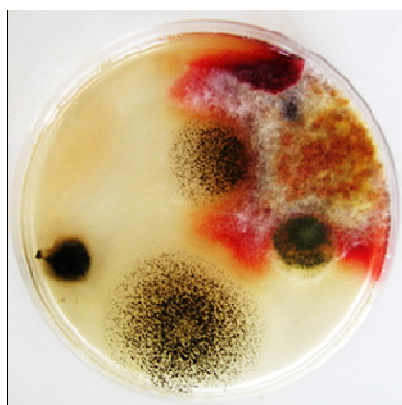

Figure 4. *Colonies of microorganisms grown on a Petri dish*

For growing microorganisms found in soil, a plant fertilizer as a source of nitrogen should be added. As a result of their intensive enzymatic activity, colonies of moulds are observable already after couple of days.

Chemoorganotrophs - yeast classified in the

kingdom of Fungi are unicellular microorganisms. They are able to break down their food through both aerobic respiration and anaerobic fermentation. The basic anaerobic catabolic process of these microorganisms, glycolysis, represents the conversion of mostly hexoses, to pyruvate. Sucrose, the saccharide found in beet sugar and molasses, is hydrolysed to glucose and fructose by invertase, an enzyme found in yeast. The major source for energy production in the yeast, *Saccharomyces cerevisiae* (baker's yeast), is glucose and glycolysis is the general pathway for conversion of glucose to pyruvate, whereby production of energy in form of ATP. *Saccharomyces cerevisiae* cells use three major pathways for growth on glucose:

First, the fermentation of glucose:

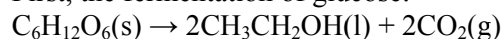

Second, the oxidation of glucose:

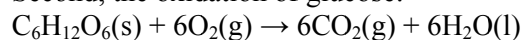

Third, the oxidation of ethanol:

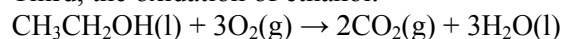

Yeasts grow best in a neutral or slightly acidic pH environment, in temperature range 20°C – 40°C with its optimum around 35°C.

4.3. Observation and work with variables

In the first session pupils observe decaying process of paper placed on soil in the classroom set observation. They are asked to keep all conditions identical with the conditions affecting paper outside. They are to notice various factors which could be the cause of observed change. Some of them are obvious (e.g. presence of soil, water) but some are harder to notice (e.g. temperature, light conditions, organisms in soil, etc.). In the second part of the session (which takes place after conclusion of the first part after two or three weeks) they are asked to change or eliminate one factor which they think causes decay. Based on their knowledge gained from their previous experience and current observation pupils tries to answer the question by formulating prediction and designing an experiment. Finally after two or three weeks they formulate conclusions. Those might be reached only after discussion about results coming from all groups in the classroom as each group could work with a different independent variable. Pupils identify independent variable and express relationship between independent and dependent variables without explicitly formulating hypothesis. The simple table helps them see

clearly the relationship they are about to prove or disprove.

Which factor have you eliminated / changed?	What do you expect to happen?	Did you prove your expectation?
---	-------------------------------	---------------------------------

Table 1. Relationship between variables (from pupil's worksheet)

The task demonstrates the way of getting familiar with identification and manipulation of variables typical for experimental work. It is also stressed and analysed why just one factor can be altered.

Following session gives students very similar opportunity to identify factors which enable growth of microorganisms so they can observe them with a naked eye. They are asked where microorganisms can be found and why we do not see them. Another question challenges them to come up with the way how we can notice or observe them except using a microscope. In order to multiply them they use analogy with their own needs for living in order to prepare very simple soils solidified by jelly where they can grow. Pupils shortly expose prepared soils to items or environment where they expect presence of microorganisms and close the vessel (jar or Petri dish). Invisible world becomes identifiable by actually seeing colonies of moulds after several days. Pupils are asked to provide arguments and explain why they can see colonies of moulds on prepared soils but they do not see any microorganisms on items they expected them to be present.

Notes about composition (nutrition requirements) and conditions in which microorganisms grow and multiply help in another task to prevent food from spoiling (session 3). They are expected to manipulate with variables identified earlier.

In session 4 pupils work with yeast. They are familiar with it from home when it is used for baking. Pupils are asked to propose essential ingredients and conditions which are needed to activate this kind of microorganisms. Pupils are expected to combine information they have about using yeast from home and knowledge about nutrients which microorganisms need they learnt in previous sessions.

Ingredients	Conditions	Yeast activity
1. Yeast* +		
2. Yeast* +		
3. Yeast* +		

* The same amount of yeast in all settings

Table 2. Ingredients and conditions for life activity of yeast (from pupil's worksheet)

4.4. Operationalization and taking data

Presence of microorganisms in environment is observed not only directly but also by noticing their metabolic activity in form of spoilt food, produced gas or raised dough. Pupils are asked to work with variables which represent operationalization of living activities of microorganisms when they are asked to prevent food from spoiling. They do not see microorganisms with their naked eye but they know about the outcomes of their metabolic activity. They define it and manipulate with their living conditions. Dependable variable is previously defined measurable manifestation of their vital activity – change of food colour, change of consistency, smell, etc.. It is appropriate to mention here that observing decaying paper is also the matter of operationalization.

Another example of operationalization is an attempt to quantitatively express metabolic activity of yeast by measuring of produced carbon dioxide in certain time. Assuming that the amount of fermentable sugar is sufficient, then the formation of CO₂ is directly dependent on the amount and activity of fermentative enzymes. Amount of enzymes is directly dependent on the number of healthy yeast cells.

Pupils are familiar with the way yeast exhibit certain change when it is used in baking. They observed increasing of volume when making dough. Pupils are asked to design the way how to measure or how to catch and measure produced gas. Pupils learn here to take data and make notes about them in a predefined organized way (the table for them is suggested) and plot a graph. Pupils still need to come up with appropriate tools and techniques to gather data which can be further analysed and interpreted.

Time
(...)*
Amount
of gas
produced
()*

* Add a unit

Table 3. Example of a predefined table for pupils
(from pupil's worksheet)

Variety of methods with a different accuracy leads to different results even when measuring was done with the same amount of yeast, sugar and water in every group. Discrepancy leads to identifying an error and reliability of particular methods. This step requires discussion of all groups in the classroom.

5. Conclusion

Essential features of science process skills introduce students to many important aspects of science while helping them develop a clearer and deeper understanding of some particular science concepts and processes. The path from formulating scientific questions, to establishing criteria for evidence, to proposing, evaluating, and then communicating explanations is an important set of experiences for school science programs.

The research literature indicates that when science process skills are a specific planned outcome of a science program, those skills can be learnt by students. Those skills are broadly transferable abilities and characterize scientifically literate person. It is therefore desirable they become essential part of science curriculum in the country.

6. References

- [1] Holbrook HJ, Rannikmae M. The Meaning of Scientific Literacy. *International Journal of Environmental & Science Education*, Vol. 4, 2009, no 3, pp. 275–288.
- [2] Laughsch RC. Scientific literacy: A conceptual overview. *Science Education*, Vol. 84, 2000, no.1, pp. 71 – 94.
- [3] Bilgin I. The Effects of Hands-on Activities Incorporating a Cooperative Learning Approach on Eight Grade Students' Science Process Skills and Toward Science. In *Journal of Baltic Science Education*. Vol. 5, 2006, No. 9, pp. 27 – 37.
- [4] Padilla M. The science process skills. In *Research Matters-to the Science Teacher*. 1990.
<http://www.educ.sfu.ca/narstsite/publications/research/skill.htm>. [visited 4-Apr-2005]
- [5] Banchi H, Bell R. The Many Levels of Inquiry. In *Science and Children*. Vol. 46, 2008. No.2, Washington, D.C. – National Science Teachers Association. pp. 26-29.
- [6] Olson S, Loucks-Horsley S. *Inquiry and the National Science Education Standards: A Guide for Teaching and Learning*. Washington, D. C., National Academy Press. 2000.
- [7] Bransford JD, Brown AL. *Cocking How People Learn: Brain, Mind, Experience, and School*. Washington, D. C., National Academy Press, 1999.
- [8] Harlen W. *The Teaching of Science in Primary School*. London, David Fulton Publishers Ltd., 2002.
- [9] Kotuláková K. Diagnostikovanie žiackych reprezentácií vybraných biochemických javov. Rigorózna práca (Thesis), Trnava University, Trnava, 2004.
- [10] Driver R. Guesne, E., Tiberghien, A. *Children's Ideas In Science*. Buckingham, Open University Press, 2002.



INTEREST IN THE SCIENCE – THE BREAKPOINT

**Juraj Slabeycius, Peter Hanisko,
Daniel Polčín**

*Faculty of Education, Catholic University in
Ružomberok,
Slovakia*

juraj.slabeycius@ku.sk,
peter.hanisko@ku.sk, daniel.polcin@ku.sk

Abstract. *The article is devoted to the analysis of the causes, why most pupils consider natural sciences, especially physics, boring, difficult and unhelpful. The authors present a brief overview of Jean Piaget's theory of cognitive development and the resulting pedagogical practices of pre-school children education. Methods invented by Maria Montessori and Boris Nikitin enable to fully develop the children's creative potential*

and thus to facilitate their schooling. A set of development games created by Nikitin, envisages the full use of sensitive phases in the cognitive development of the child. The authors describe the current state of education in Slovakia. The reform of elementary and secondary education had ambitions to improve Slovak educational system. After five years of reform, it was found that not all reform objectives have been met.

Keywords. Piaget's theory, Montessori, Nikitin's development games, school reform in Slovakia.

1. Introduction

Subjects like mathematics and physics are not very popular at primary and secondary schools. Students consider them to be too difficult, tedious and of little need for life. Public opinion largely contributes to their beliefs, supported by television and other mass media. This reflects not only in the declining ability of young people to think critically, but also in the lack of interest in studying science and engineering disciplines at universities. The result is a decreasing average level of technically oriented graduate faculty alumni; industry, and particularly the development intelligence is in lack of skilled workers. The causes of this condition are many; in this paper we shall analyze some of them.

2. Patterns of development of children's thinking

Natural cognitive development of children's thinking in accordance with the theory of Jean Piaget [1, 2] can be divided into several phases, which are interlinked. Piaget studied how the relationship between the child (cognizant entity) and environment (learning objects) is evolving in different age. Piaget distinguishes specific stages of cognitive activity in the development of an individual, with each stage to be assigned specific structures of thought. These structures change in the course of the development. Piaget demonstrated that any particular level of knowledge is a result of previous development. It's not just adding more elements to the previous level, but its depth reorganization and transformation.

According to Piaget a child is, in its nature, an investigator – he makes experiments with things and people around, tries to find out, what happens after he's done something. Based on his

experience he conceives working theories – the so-called schemes that illustrate how the world works. The child is keen to attribute every new object or experience into an already existing scheme (assimilation). If a new object or event doesn't fit into any scheme, the child tries to adapt (accommodate) it to the new situation (accommodation). The child's thinking and their perception of the world arises as the equilibrium between assimilation and accommodation. Some incentives, by their novelty and demands on the child's behalf, create a state of disequilibrium in his cognitive system. The child tries to renew the equilibrium. Equilibration is the movement back and forth between equilibrium and disequilibrium that promotes development of more complex thought and understanding. It is a dominant mechanism in the development of the child's cognitive abilities. The child's strive towards a cognitive maturity is, according to Piaget, gradual (successive) and encompasses four consecutive evolution stages. Each stage can be described as a set of organized cognitive structures or schemes. We distinguish four evolution stages: sensorimotor, pre-operational, concrete operational and formal operational stage. In the sensorimotor stage infants construct an understanding of the world by coordinating experiences (such as seeing and hearing) with physical, motoric actions. The next stage - pre-operational – is characterised in that the child do not yet understand concrete logic and cannot mentally manipulate information. In the concrete operational stage are children able to solve problems that apply to concrete events or objects, but hypothetical thinking has not yet developed. The fourth stage – formal operational stage – finish the cognitive development. The young man/woman is able to think about abstract concepts.

3. Application of Piaget's theory in educational practice

Piaget's works have theoretically justified educational basics, that were already in the past formulated by renowned pedagogues, such as...Jan Amos Comenius in his opus *Didactica Magna* [3] accentuates the principle of evidence (clearness) and activity, the pupil is to retrieve new information by means of his direct experience and to use them in practice. According to Comenius the principle of adequacy – the teacher should consider age- and individual abilities of pupils. Equally, he points

out the need of constant revision of gained knowledge.

Already by the beginning of the 20th century Maria Montessori developed a wholesome program for a pupil's self-realization. Her didactics and methodology are being applied in many Montessori schools worldwide [4, 5]. Montessori discovered, that in early stage of a child's development there exist the so-called sensitive phases – periods of enhanced sensitivity, when a child is extraordinarily sensitive in terms of perception and understanding of certain external phenomena, in order to acquire character traits, abilities or knowledge. These stages persist for a limited time and get lost forever, disregarding of their being used or not.

During the sensitive phase the child learns very quickly and easily, with joy and interest. According to Montessori sensitive phases are age-limited as follows: movement stage (1 to 4 years), stage of order (up to 3 years), language (spoken utterance) stage (up to 6 years), stage of fascination with little objects (up to 2 years), social relationships stage (2 to 6 years), sharpening of senses' stage (0 to 6 years). These periods endure for a limited time and get lost forever, disregarding of whether they've been used or not.

Maria Montessori discovered that all children discern natural tendencies towards improving their abilities by means of handling objects they find in their immediate environment and are strongly attracted to them. Children use these objects spontaneously, independently and repeatedly returned to them, working with admirable concentration. At the same time, children don't like adult interfering, they are most content on condition of independent concentration on tasks set out.

After achieving their work children feel relaxed, happy, internally content and full of energy. Children, that have fully used their sensitive phases, get a much better starting position in their future life, than other children – they easily understand, their gifts (wits), be they artistic, manual or scientific, develop harmonically. Success motivates children for other activities. A content child spontaneously develops its inner discipline.

Another pedagogical school to accentuate pre-school children's development is the school of Boris and Lena Nikitin [6,7]. Their school is derived from the works of M. Montessori, with their further modifying and enriching by

Nikitin's proper ideas. Their methodology has been successfully tested on their own seven children. The Nikitins developed a whole set of developing games and activities, targeted on the child's physical and spiritual evolution. They accentuate mutual interconnection of spiritual and physical activities, principal to a harmonious evolution from early childhood. Their games are destined for children from 2 years age, whereas each game has so many different difficulty levels to be considered interesting even for older children, adults included. Their development games, such as attern cubes, unicubes, geocubes, logical lines, squares, number towers and other are sold under the name "Nikitin-materials" [8].

Nikitin's methodology effectively uses the phases of sensitive development. All of Nikitin's children have, by means of plays, mastered reading already by the age of 3-4, reading was very amusing and provided them with many new useful information.

The Nikitins, similarly to the Montessori school, point out independent creative activity, without useless interference of adults. Parents (i.e. teachers in kindergartens) are only to create an appropriate environment, with as much stimulus as possible. Children should deal only with what they like to do and for as long, as they feel distracted. The parent should only direct their activity and respond to children's questions. Under no circumstances the child should be forced to such activities, neither get overfed by them. With first signs of lowering interest the Nikitins recommend that the game be ended and promise be given to repeat the game tomorrow. The child should look forward for the game. It is very important to set out appropriate time for developing games, depending on the age and dispositions of a child, and on its momentous mood.

4. Actual situation of education in Slovakia

According to estimations, over 90% of children that start school tuition are smooth, with their cognitive evolution level corresponding to their age. Only a little percentage of children can be attributed to a group of exceptionally gifted, precisely said – it is those children, that have been happy enough, thanks to their parents, to fully exploit the sensitive stages of their evolution. In our population, from year to year, there rises the ratio of smooth (problemless) children. Their majority originates from socially

feeble or incomplete families, especially the Roma minority. These children didn't yet get a chance to normally develop, such handicap is very difficult to eradicate in school age. Very few of them is objectively dysfunctional by physical or mental diseases. A big problem is their lacking behind in social development and insufficient moral education.

Similar to early neglecting of prevention leading to further incomparably high costs of a patient's treatment, neglecting of pre-school education may cause the state to necessarily spend much higher costs, related to lower education achieved, less opportunities for self-realization on the labor market, aggressivity and criminality of such handicapped children.

The state must not economize on the means of enlightenment activities amidst parents. It is essential to find appropriate ways (depending on the level and social status of parents) how to best facilitate (literature, schoolings, evident case studies) working essentials of children from 0 up to 6 years of age. The state should financially support developing games and utensils, invest into equipment of school facilities and education of personnel.

Whereas during pre-school age it is the parents who are responsible for a healthy children's development, in the course of school tuition this role is delegated, at least partially, to the school. Of course, the family bears its part of responsibility. Almost all of the children come to school with interest and big expectations, they're proud to be pupils already. They discern a very positive affection for the teacher; learn with joy without experiencing any negative emotions. The school mostly provides enough space to master new knowledge, its methodology and didactics is for the better part in accordance with newest knowledge. But gradually there comes into place a predominance of education by means of delivering utter, complete information, pupils get overburdened with useless facts without accenting their interconnection, the interpretation isn't sufficiently comprehensible and attractive. Pupil's incentive gets repressed and quite contrary – obedience and memorizing is required, no impact is given to the development of creative thinking. By transgressing to the second level of primary education (ISCED 2) some of the children experience problems with progress, several subjects (especially natural sciences) become incomprehensible, resulting in apathy and losing interest.

A break point is achieved, with interest in math's

and natural sciences lowering inevitably. Such an attitude is supported by media propaganda, with the latter advertising such professions as manager, lawyer, economist or surgeon, to the very disadvantage of technical vocation.

The academic community was very aware of these problems, therefore it was clear for everyone, that it is inevitable to principally reform the educational system. The school reform was launched in 2008 with the Law on education and tuition [9]. Its aim was to enforce democratization, individualization and participation in the decision-making of school practice. The school reform emphasises the importance of discovering and implementing effective means of personality development. The reform has brought about more liberty and independence for schools in the educational area, and provided space for creativity (up to 30% in the educational content is beheld in schools' competence, striving for their creating own educational programs. An important positive improvement was the lowering of the amount of pupils in classes.

As for natural sciences, reform priorities have been set such as active knowledge, conceptual knowledge, active feedback, motivating scientific knowledge, implementation and development of basic knowledge by means of own cognitive activity. On the field of physical education the reform was targeted on developing pupils' competence. That means – transition from lectures (direct knowledge delivery) to an experimental approach, by means of active physical phenomena comprehension.

These goals were to be attained by reducing of educational content, lowering the pupils' number in classes and division of classes when lessons, containing experimental activities. Such an approach requires more efforts and readiness from the teacher, enough time and appropriate conditions (good equipment of physical labs, teachers' schooling of new methods).

5. Conclusions

After five years of reform have passed in Slovakia, one discovers that in physics' educations the goals have not been met. In a pedagogical survey, conducted amidst more than 160 physics teachers on secondary schools, some 90% of teachers state that the level of pupils, arriving from elementary schools, has lowered considerably and more than 80% of teachers is convinced, that the results of leaving

physics examination has decreased.

Partially the failure of the reform has objective causes. One overestimates the importance of schools' equipment with new computing technology and multimedia tools, whereas in some schools one lacks experimental tools. Teachers are overcharged, due to low salary they must have additional lessons, or they get side jobs.

An important momentum is the insufficiency of adequate schoolbooks and methodological materials. In many schools directors prohibit divisions of classes for physics, thus the teacher is unable to follow the methodology goals of the reform. Big importance is attributed to subjective factors – many physics teachers haven't innerly accepted the need to provide children with the chance of actively acquiring new knowledge.

Of course, such way of teaching requires more time, very good preparation, patience and the ability to estimate the limits of the children's creative abilities. They are not aware, that knowledge, which one acquires independently himself, is much more precious, than a much bigger amount of knowledge served by direct tuition. The authors of the reform committed mistakes in underestimating the importance of special teachers' schooling, and in launching the reform widely for all schools without preliminary testing such form of tuition in schools, whose teachers have the required capabilities.

6. Acknowledgement

The authors would like to thank the Slovak Cultural and Educational Grant Agency for supporting of actual work under grants KEPA No. 032KU-4/2012.

7. References

- [1] Piaget J. The Child's Conception of the World: A 20th-Century Classic of Child Psychology. Rowman & Littlefield Publ., 2007
- [2] Wadsworth BJ. Piaget's theory of cognitive and affective development: Foundation of constructivism. Boston: Allyn&Bacon Classic Edition, 2003
- [3] Komenský JA. Vel'ká didaktika. Bratislava: SPN; 1991. English translation: John Amos Comenius J.A. The Great Didactic. <http://openlibrary.org/books/OL24155794>

[M/The great didactic of John Amos Comenius](#)

- [4] Hainstock EG. Teaching Montessori in the home. Random House, 1968
- [5] Montessori M. The Montessori method. New York: Cosimo Inc., 2006
- [6] Nikitin B. Stupenki tvorchestva ili razvivayushchie igry (in russian). Moskva: Prosveshchenie, 1989. English translation: Nikitin B. The creative ladder: Development Games. www.icteachers.co.uk/resources/general/ladder.rtf
- [7] Nikitin B, Nikitina L. Die Nikitin-kinder: ein Modell frühkindlicher Erziehung. Kiepenheuer & Witsch, 1978
- [8] Nikitin-materials. <http://www.logo-verlag.de/englisch/SID=5148e3b219ea1e378e9c09753fdffa74/shop/index.php3> [visited 30-Apr-2013]
- [9] Zákon o výchove a vzdelávaní (Law on Education). Collection of Laws No.245/2008



THE TEACHER OF CHEMISTRY AND THE CREATION OF TEST ITEMS

Tereza Kudrnová, Renata Šulcová
*Charles University in Prague, Faculty of Science,
Department of Teaching & Didactics of Chemistry,
The Czech Republic*
terka.kudrnova@email.cz,
rena@natur.cuni.cz

Abstract. *The test is a very effective and objective way to prove the students' results in educational process. Although the tests are the inherent part of evaluation, in practice it seems that teachers aren't well prepared for creation of test items. Many teachers don't know that the test items creation have strict rules which must be observed. Marginalization of rules for test items creation can lead to misunderstanding, to frequent errors and students' questions. In this article there are demonstrated common mistakes in test items and main rules for the*

creation of different types of test items. It is summarized in several recommendations for teachers.

Keywords. Type of test item, rules for test items, norm-referenced measurement, criterion-referenced measurement.

1. Introduction

The test is a very effective and objective way how to prove the students' results in educational process especially when the large number of students is in class. Currently the tests are an inherent part of the evaluation in educational process, but in practice it seems to be very difficult to create the correct test item and to assemble the whole test.

Some teachers create themselves both – the test items and also the whole tests – but many of them don't know that creation and formulation of the test items have strict rules that must be observed. Other teachers are inspired by their colleagues or choose the test items from the books and internet sources, but it's also necessary to have elementary knowledge about testing and make control of chosen items.

Marginalization of the strict rules for test items creation can lead to misunderstanding of test items, the frequent errors and students' questions.

2. Courses associated with testing

In the tests obtained by many different internet sources or from printed books it could be seen that their authors don't comply requirements with the elementary testing rules. This fact relates to the question whether the preparation of future teachers of chemistry is sufficient in creating test items and whole test.

Therefore we have decided to make a comprehensive overview of courses or subjects associated with testing which are taught at Czech universities. Based on the list of study programs published by Ministry of Education, Youth and Sports of the Czech Republic we've found all study programs (focused on chemistry education) and we've studied their study plans and courses (subjects). From the available internet sources we've found in the end that courses directly related with testing or creating of test items almost haven't been taught at Czech universities and faculties for prospective teachers or graduated practicing teachers of chemistry. But it's necessary to say that it isn't possible to find

any overview of taught courses on web site of some universities.

Practically the only universities offering courses focused on testing and creating of tests' items are Pedagogical faculty at Charles University in Prague – general courses of testing – and the Faculty of Science at Charles University in Prague – special courses of testing in chemistry.

At the Faculty of Science there works Chemical Section the Department of Teaching and Didactics of Chemistry which is designed especially for chemistry teachers. There are offered three special courses associated with testing (all of them are optional):

- 1) Theory and practice of forming chemical educational tasks
- 2) Formulation and statistical processing of chemical tests
- 3) Organic chemistry and Biochemistry in problems.

Some elementary rules of creating tests and tests' items are the part of compulsory didactic courses and subjects at many pedagogical faculties in our republic. But what does the results from information listed above mean? The offer of courses associated with testing and test items isn't sufficient for teachers, especially for chemistry teachers. Due to this conclusion we have decided to summarize some basic rules for test items creation. Also there will be shown some basic mistakes in test item creation in this article.

3. Achievement test

Generation and assembling of objectively correct didactic test focused on success is very difficult and time-consuming work.

At first it is necessary to understand whether the prepared didactic test should be used for comparison of students' relative performance – so-called differentiating test (norm-referenced measurement) or if test measures the absolute performance of a student with pre-determined criteria – so-called verifying test (criterion-referenced measurement).

The first type of the test is appropriate for determining the order of performance achieved by students. It is most suitable for Chemistry Olympiad or entrance exams. The second type of the test is more used in common school testing. It means that the test and its evaluation are focused on actual student performance and it isn't scaled with the performance of other students [1]. The rules for evaluation and classification are

determined in advance. The part of these rules is so-called minimum performance test or cut-off score. It's minimum score which is necessary to successfully execute the test.

For compilation of an achievement test is important to accurately define the expected knowledge and skills of student. For it there is necessary to build so-called specification table [1]. This specification table has to reflect these following factors:

- 1) description of the tested sample
- 2) time required to solve the test
- 3) the overall number of test items
- 4) representation of thematic units
- 5) representation of tested skills
- 6) representation of different types of test items
- 7) representation of answers (e.g. frequency of answer A or B)
- 8) item difficulty of each test item, if it's possible.

Representation of thematic units is determined by the ratio of hours which are dedicated to these thematic units.

For example: if in some form of learning process of biochemistry is dedicated the ratio of thematic units in this manner: bio-macromolecules are discussed in 75 % lessons and the biochemistry cycles are discussed in 25 % lessons □ then it is not right to focus most of question in test on the biochemistry cycles. This ratio is given by curriculum as the representation of tested skills [2]. Representation of different types of test items should be balanced. It means that one thematic part may not be composed only by multiple-choice test items and the other one only by opened items. It isn't too correct to compile an achievement test from the test items of the same type only: it isn't right to test only contained multiple-choice items, because when the test item has 4 question offers, it's 25% probability of guessing. It means that cut-off score has to be greater than 25 %. The possibility of guessing is always reduced by inclusion of opened items. In opened items student has to show activity of his knowledge or skill and no possibility of guessing exists.

4. Specification table

Following specification Table 1 shows an example of thematic plan of one school year at high school in which biochemistry is taught and discussed [3].

Based on the Table 1 there is possible to assemble a specification Table 2 for the final test at the end of the school year which is criterion-referenced measurement. This means: it can measure the level of acquired knowledge and skills in thematic unit of biochemistry.

Nr.	theme	number of lessons	lessons in %
1	lipids	3	6,1%
2	terpenes	2	4%
3	alkaloids	4	8,2%
4	heterocycles	4	8,2%
5	carbohydrates	6	12,2%
6	proteins	6	12,2%
7	nucleic acids	6	12,2%
8	vitamins	4	8,2%
9	enzymes	4	8,2%
10	metabolism	10	20,4%

Table 1. Thematic plan of biochemistry

sample:	7. B, 28 students										Frequency %
time:	90 min										
themeNr.	1	2	3	4	5	6	7	8	9	10	
knowledge	1		1	1	2	1	2	2	2	5	47,2 %
application of knowledge	1		1	1	1	2	2	1		3	33,3 %
work with information		1	1	1	1	1			1	1	19,4 %

Table 2. Specification table

The following Table 3 shows the distribution of types of test items in the final test in thematic unit of biochemistry.

sample:	7. B, 28 students										Frequency %
time:	90 min										
theme Nr.	1	2	3	4	5	6	7	8	9	10	
multiple-choice items	1		2		2	2	2	2	1	5	47,2 %
opened items	1			1	1	1		1	1	2	22,2 %
true-falls items		1		1		1	1		1	1	16,2 %
matching items			1	1	1		1			1	13,9 %

Table 3. Type of test items

5. Basic rules for test items creation

For creation of test items there exist general rules, which are applied on all types of test items.

- 1) If there is any task negative it's necessary to make it bold and underlined the negative.
- 2) The test item may not be a "catch question".
- 3) The test item must not test the knowledge or skills from other subject which have no relationships to the test subjects.
- 4) It isn't right in distractors to use the word like *always, never, each, all, no and so on*. Distractors (= marking for incorrect solutions) with these words usually show differing measurement, they are selected excessively often or aren't selected at all.
- 5) The test item shouldn't contain text which isn't necessary to find correct answer. Unnecessary text can be confusing and it could impede the student in solving the test item.
- 6) The assignment of test item must be absolutely clear and unquestionable. The author of test items must suppose that student filling an achievement test doesn't always have a possibility to ask questions and to solve uncertainties.

5.1. Multiple-choice items

Multiple-choice test items are used very often due to their easy measurability. Let's have a look at some mistakes in creating of test items in selected examples.

Task 1[4]

Amino acids are:

- A) substituted derivatives of carboxylic acids
- B) functional derivatives of carboxylic acids
- C) basic structural units of nucleic acids
- D) all essential

The correct solution of this test item is an offer A.

Distractors (= marking for incorrect solutions) are B, C, D. Offers A and B are the first structural mistake in this test item because they can be mutually preclusive. Also if the students know that there exists only one correct solution for the test item then it is very common that the multiple-choice test item becomes only dichotomous item. The students decide only between offers A and B and the probability of guessing the correct answer will increase from

25 % to 50 %. This fact is confirmed by the structure of distractor D where the word *all* is used. Students used to solve test items can know that distractors like this one are false because there are usually some exceptions.

Task 2[5]

Sulphur containing amino-acids are:

- A) serine and cysteine
- B) cysteine and methionine
- C) methionine and serine
- D) only serine

The correct solution of this test item is an offer B.

Basic structural mistake in this test item is the fact that in three distractors (A, C, D) appears the amino acid serine. So if the students know that serine is the amino acid without sulphur atom they will not think about all offers because the correct solution is clear. Therefore it's better to offer one or two different amino acids in each of distractors.

Task 3 [6]

Which toxic gas is generally produced by incomplete combustion of carbon compounds?

- A) carbon dioxide
- B) carbon monoxide
- C) hydrogen sulphide
- D) hydrogen cyanide

The correct solution of this test item is an offer B.

This is a multiple-choice item but it's true that from the formulation of introduction text we can deduce that students will decide only between offers A and B. They exclude distractor C immediately because the offered compound doesn't contain any carbon atom. Therefore it's necessary to change distractor C in this test item at least.

From previous examples we can formulate some basic rules to create multiple-choice test items:

- 1) The distractors have to be balanced. They must relate to the same subject and it is also recommended the same or similar length of each distractor.
- 2) It isn't right to use the distractor e.g. *all statements are correct or incorrect*. Statistic measurement shows deviation in these distractors because they are very different from the others and therefore they are excessively selected or are not selected at all.
- 3) One distractor should not exclude the other distractors.

5.2. Open items

Although the evaluation of open items is more time-consuming than the evaluation of closed test items, the opened items are used very often in testing of chemistry, too. Their main advantage is impossibility to guess the correct answer. But it seems to be very difficult for authors to create a correct opened test items with the single clear solution.

Here are some rules for creation open test items:

- 1) If the open item has more parts, it's necessary to mark clearly the places for each part to avoid confusion.
- 2) The test item must have only one correct answer. When more than one possible correct solution of one item occurs, the evaluation is very difficult and not enough objective.
- 3) It isn't possible to create an open item when you know the fact that only one, two or three answers could be considered. For example – if there are assessed only two or three possible answers, the open item becomes easier than multiple-choice item with four offers.

5.3. Matching items

Creation of correct matching items is difficult and time-consuming work, too. But matching items are good parts in the achievement test because they can exercise the other type of students' thinking then multiple-choice items, opened items or true-false items can.

Task 3 [7]

Pair the properties of sulphuric acid and specific examples of their application:

- A) oxidative effect of concentrated sulphuric acid
 - B) acidic properties
 - C) dehydration effect of concentrated sulphuric acid
 - D) analytical reagent for precipitation reaction
 - E) oleum creation
-
- (1) blackening of sugar cubes
 - (2) $\text{H}_2\text{SO}_4 + 2 \text{SO}_3 \rightarrow \text{H}_2\text{S}_3\text{O}_{10}$
 - (3) $\text{Cu} + 2 \text{H}_2\text{SO}_4 \rightarrow \text{CuSO}_4 + \text{SO}_2 + 2 \text{H}_2\text{O}$
 - (4) $\text{Zn} + \text{H}_2\text{SO}_4 \rightarrow \text{ZnSO}_4 + \text{H}_2$
 - (5) $\text{BaCl}_2 + \text{H}_2\text{SO}_4 \rightarrow \text{BaSO}_4 + 2 \text{HCl}$

The correct solution of this test item is A □ (3),

B □ (4), C □ (1), D □ (5), E □ (2).

Three structural mistakes are in this test item. The first is the offer E. In test item of Task 3 students have to demonstrate their knowledge about the chemical properties of the sulphuric acid, but the offer E (oleum creation) isn't possible to mark like a chemical property.

The second problem is the offer (1). It is different from the others which are expressed in form of chemical equations.

The last problem is the same number of offers marked as A – E with offers marked as (1) to (5). The test item in this form is very easy for students. Students' knowledge can be tested better when the ratio of offers is not 5:5 but e.g. 3:5 (it's also better with regard to scoring item).

Here are some rules for creating of matching items:

- 1) It's better when the number of offers is greater than the number of claims which should be assigned. It makes the test item more difficult.
- 2) All offers should be balanced, no one can deviate however.
- 3) No one offer should be primarily excluded. For example all of offers A to E must be theoretically paired to offers 1 to 3.

6. Conclusion

Due to the probe into plans of courses and subjects suitable for our prospective teachers of chemistry there was found that only one Czech university (Charles University in Prague, Faculty of Science) is offering three courses associated with testing for future teacher. If the testing in school is taught at the other universities, it is probably a part of some didactic courses. Unfortunately it isn't possible to find out any courses associated with testing which are based on web sites of that faculties. It was found definitely that testing in school isn't mandatory subject for prospective teachers, that it is maybe the reason of often construction mistakes in achievement tests which are available especially from internet sources. In this article there was made an analysis of some test items from internet sources. Based on this analysis there were formulated basic rules for creation of the different type of test items.

It would be good to strengthen the teaching associated with testing for prospective teachers in future. Many students' mistakes by solution of test items could be caused by construction mistakes. The creation of construction mistakes

in test items brings any risk that the test item does not test desired evaluation task.

7. Acknowledgements

This work was created from institutional resources of Ministry of Education, Youth and Sports of the Czech Republic for the support of science and research.

8. References

- [1] Schindler R, editors. Rukověť autora testových úloh. Praha: Centrum pro zjišťování výsledků vzdělávání; 2000.
- [2] Centrum pro zjišťování výsledků vzdělávání. Katalog požadavků zkoušek společné části maturitní zkoušky. Zkušební předmět chemie. Praha: Cermat; 2008.
- [3] Popová E, editor. Učební plány pro gymnasium. Dvořákovo gymnasium Kralupy nad Vltavou; 2011. <http://www.dgkralupy.cz/> [visited 5-May-2013].
- [4] Kosová N, Šedivá J, Ustahalová J, editors. SIPVZ – Projekty, Test bílkoviny. Gymnázium Jihlava; 2006. <http://www.gymnazium.ji.cz/docs/sipvz/chemie/vyssi/testy/09bilkov.doc> [visited 5-May-2013].
- [5] Klečková M, Vašíčková M, Pavlíček M. Labyrint chemie. Olomouc: Přírodovědecká fakulta UP Olomouc; 2008.
- [6] Luňák S, Šíma P. Sbírká úloh z anorganické chemie I. Praha: Archa; 2012. <http://www.gybot.cz/data/X/V/S/3.pdf> [visited 5-May-2013].
- [7] Hrabal V, Lustigová Z, Valentová L. Testy a testování ve škole. Praha: Univerzita Karlova; 1994.

INNOVATION IN STATE CURRICULUM AND TEACHING NATURAL SCIENCES IN LOWER SECONDARY EDUCATION IN SLOVAKIA

Mária Siváková, Peter Kelecsényi,
Mariana Páleníková

National Institute for Education, Bratislava,
Slovak republic

maria.sivakova@statpedu.sk,
peter.kelecsenyi@statpedu.sk,
mariana.palenikova@statpedu.sk

Abstract. *This contribution deals with the State curriculum at lower secondary education in Slovakia and its current innovation efforts focused on natural sciences.*

Educational standards of individual courses have always been perceived as documents open to modifications subject to experience from their practical implementation in fieldwork.

The update of the curriculum takes place in the framework of self-reflection of the past experience with the State education programs. Increase in time allocation for the subjects “Mathematics and Informatics” and subjects in the area “People and Nature” (physics, chemistry and biology) is foreseen. However, the principal and key innovation in all subjects is related to the content and performance standards.

Keywords. Competencies, content standards, framework curriculum, State curriculum, performance standards, educational areas, educational standards.

1. Introduction

With four years of the education reform being under way Department of Education of Slovak republic has asked National Institute for Education (herein as SPU) to elaborate on the state curriculum. Innovation of state curriculum has been approached more thoroughly rather than via mechanical update of contents in individual subjects. Discussions were activated and answers sought to both theoretical and practical questions related to structuring and executing educational programmes in practice across expert groups of employees, members of curriculum committees, member of working groups and management.

The task force on innovation of the state curriculum was titled “Retrospection” [1].

2. Innovation basis

“Retrospective” self-reflection at the state curriculum comprised of:

- Harmonization of definitions within educational fields and thematic areas of pre-primary, primary and lower secondary curricula,
- Innovation of curriculum framework
- Innovation of educational standards.

3. Innovation of education programme Human and Nature

The central issue and the most discussed general problem in innovating education programmes in any subjects in primary schools has been a time allocation within a framework curriculum. Based on the recent (2009) PISA results, where Slovakia ranked well behind the top performing countries within OECD, Department of education had asked to put more weight in terms of time allocation on natural science programmes.

Modified framework education scheme has been designed with increased weekly time allocation to the subjects in education programme Human and Nature: Physics to 6 classes, Chemistry to 5 classes and Biology to 7 classes. Time allocation for Physics was increased by one class per week following a schedule 0-2-1-2-1 as of sixth grade. Time allocation for Chemistry was increased also by one class per week following a schedule 0-0-2-2-1 as of seventh grade. Finally, time allocation for Biology was increased also by one and a half class per week following a schedule 2-1-2-1-1 as of fifth grade.

4. Innovation of aims within education programme Human and Nature

The aim of the state curriculum in education programme Human and Nature is to modify existing model of education, where students passively capture new terms and notions from a teacher based on a delivery of information.

Contemporary model of education puts more emphasis on active adoption of concepts and contents by students. Teachers’ role is transformed to help comprehension of natural phenomena, construct new terms and understand links between them [3].

Such process of education entails more research and experiment based approach to objects and phenomena by the means of active participation. Task to create and comprehend relevant links is hence transferred to students. Optimal methods to involve students to individual activities, where students practice their knowledge, are then left to a teacher. This is in line with a long-run process to build the knowledge base [2].

The primary goal of education programme Human and Nature is to develop natural science literacy. It aims to enhance students’ personality in terms of his/her activity and attitude.

Natural sciences education shall allow students to improve their capabilities to:

- Explain natural phenomena in their imminent environment and propose methods to verify explanations,
- Defend own statements and procedures by using logical argument based on evidence,
- Communicate their knowledge in the field of natural sciences both verbally and in writing,
- Collect, classify, analyse and assess information from various information resources, use information to solve problems,
- Differentiate arguments based on expertise and personal views, reliable information from unreliable, practice critical thinking,
- Understand that there are mutual and complex inconclusive relationships between science, technology and society,
- Understand different angles of science as political, economic, moral or ethical and their specific and/or global consequences,
- Cooperate in problem solving
- Critically assess and foresee use of expertise to benefit of society and possible issues related to their application, e.g. for environment.

Students shall acquire the following interests and attitudes:

- General interest in nature and world of technology,
- Positive attitude towards problem solving,
- Open mind towards new discoveries in science and technology,
- Positive relationship towards health protection and healthy life style.

In the following section of this contribution, we will compare goals of natural science subjects as of 2009 with those proposed in the modified state curricula, based on aims within education

programme Human and Nature.

4.1. Goals in physics

Goals in physics were elaborated in four areas in 2009, namely in intellectual area, in skills and capabilities, in the area of attitude and in social area.

We propose eleven general goals for the subject of physics in the currently innovated state curriculum.

Students

- apply empirical methods – observation, performing experiments, measuring and processing the measured quantities
- explain selected phenomena in physics in their immediate environment and propose methods to verify their explanations,
- present and defend their procedures and statements by evidence based reasoning
- communicate both verbally and in writing, master symbolic, tabular and graphical presentation
- apply in practical exercises their knowledge of concepts, laws of physics, facts, learned mathematic procedures and other information from relevant resources,
- differentiate reliable information from non-reliable – think critically,
- solve problems, which require merging knowledge acquired in various areas of natural science,
- understand historical timeline and evolution of physics within sciences and influence of technology on its development and progress in society,
- assess usefulness of scientific knowledge and technical discoveries for social development as well as issues related to their use and environment,
- learn to be open to new discoveries in physics and technology,
- acquire positive approach to health protection and environmental protection.

4.2. Goals in chemistry

Goals in chemistry were elaborated in two areas in 2009.

We propose eleven general goals for the subject of chemistry in the currently innovated state curriculum.

Students

- encounter with basic information about substances important in daily life,

- discover properties of substances and their transformation by observation, measurements and experimenting,
- will understand chemical phenomena and processes,
- use technical terminology to describe chemical phenomena and processes,
- understand instructions given to them to undertake tasks and are able to complete them accordingly,
- process and evaluate data from observations, measurements and experiments,
- acquire motoric skills, intellectual and social capabilities to undertake appropriate experiments,
- plan and undertake observations, measurements and experiments,
- adopt and practice principles of safe handling of substances,
- search relevant information about use of various substances in industries, agriculture and daily life and their value for humans, environment and health safety,
- use knowledge and experience acquired in chemistry to protect health and environment.

4.3. Goals in biology

Goals in Physics were elaborated in four areas in 2009. Besides, competences in natural science were also a part of the state curriculum.

We propose eleven general goals for the innovated state curriculum for biology.

Students

- gain basic understanding about nature as an interaction of its individual components,
- will understand natural phenomena, processes and objects in their interrelated context,
- acquire information about nature by observation and search with use of different means of resources,
- analyse, interpret, classify and assess information about organisms, systems and nature,
- use proper technical language to describe processes and phenomena in living and inanimate nature,
- plan, execute, record and evaluate simple biologic observations and experiments,
- discuss importance of practical consequences of selected scientific discoveries,
- apply acquired capabilities and

knowledge to promote their health,

- protect environment and economise on natural resources,
- plan and execute simple projects in the field of biology,
- present and defend output of their work.

5. Innovation of performance and contextual

Educational standard in individual subjects comprises of two parts. Performance standard refers to a complex system of gradual mandatory requirements, which student needs to fulfil. These are assumed knowledge, capabilities and attitudes, which student has to achieve proportionate to his/her abilities. A teacher may specify and enhance these in terms of various activities and tasks and may suit them to the level of students in a given class or equipment availability in given school.

One of the most important changes, which are integral part of innovated standards, is more careful focus on the output of education. Performance standard requirements are listed first in the table of educational standards due to conceptual superiority. Performance standard specifies subject goals. Compared to former educational standards, performance standard contains cognitive, affective and also psychomotoric goals.

Performances listed in standards are being developed gradually. For this reason, teacher sets more specific goals for individual performance standards. Relevant goals are being achieved step-by-step so that students master standard performance at the end of relevant academic year. On the other hand, given standards shall not constrain teacher to set additional goals, which (s)he assumes useful and appropriate to contemporary knowledge base and level of thinking of his/her students.

Achieving individual performance standards is specified by the means of contextual standards. Contextual standard defines content of material to be learned underlying relevant prescribed performance. Essential body of information and technical terms that student should comprehend and is able to explain and actively use is defined here.

Teacher may intervene into the thematic units of educational standard and modify and shift individual blocks within the academic year according to the interest of students, teachers or to the school needs.

5.1. Educational standard of physics

New approach to teaching physics carefully builds knowledge base of students based on their previous experience. Experimental activities of student dominate. Student is guided to formal understanding of the contents, and eventually to mathematic relationship and/or to generalised theoretical terms.

Research capabilities are being developed, mainly through observation, measuring, experimenting and processing measured data into tables and charts. Manual and technical capabilities of students, ability to formulate hypothesis, conclude findings, generalize, interpret data and describe their dependences are integral part of these capabilities.

In the following section, we introduce examples of former and innovated standards.

Example of the standard from 2009:

Thematic unit: Behaviour of bodies in liquids and gases

Contextual standard:

Measurement of volumes and weight of bodies floating, suspending and diving in water, definition of m/V

Term – density. Units of density: g/cm^3 , kg/m^3 .

Relationship between volume and weight of bodies from identical substance...

Performance standard:

- proceed according to the strategy: formulate problem – express hypothesis – make experiment and measurements – process, evaluate and interpret results
- produce density chart for bodies of identical substance, determine density value from the chart
- apply finding that weight of the body floating in water and weight of the volume of water discharged is identical
- determine density of small bodies
- work with MFCHT tables...

Example of innovated standard:

Thematic unit: Behaviour of bodies in liquids and gases

Performance standard:

Students

- Solve problems by the following procedure: formulate problem – express hypothesis – do experiments and measurements – process, evaluate and interpret results and measurements,
- Present results of observations and measurements on front of the class,
- Determine density of solid bodies and

liquids from measured values of their volume and weight,

- Produce chart of weight dependency on volume for bodies of homogenous substance,
- Elaborate and present a project, in which new findings are used and commented,...

Further selected examples of performance standard:

7th grade:

- Discover difference between evaporation and boiling and properties of boiling based on results of experiment,
- Model production of thermometer by experiment, formation of rain,
- Execute and evaluate meteorological observations and measurements,...

Contextual standard:

- Floating, levitating and diving bodies in water, measuring their weight and volume
- Density. symbol ρ , density unit g/cm^3 , relationship $\rho = m/V$
- Relationship between volume and weight of bodies from identical substance
- Comparing weight of two bodies floating in liquid with weight of liquid they discharge,...

5.2. Educational standard of chemistry

Contextual standard of chemistry in lower secondary education has been also partially modified. Contents has been somewhat reduced and structure simplified. Educational standard consists of five thematic units. Two of them, "Substances and their properties" and "Transformation of substances" have been allocated two classes per week in the 7th grade, further two, "Composition of substances" and "Important chemical elements and their compounds" have been allocated also two classes per week in the 8th grade and "Carbon compounds" has been allocated one class per week in the 9th grade.

Educational standard does not include thematic unit "Chemical calculations", however this topic is partially covered in the 7th grade (mass fraction).

In the following section we introduce examples of former and proposed standards.

Example of the standard from 2009:

Thematic unit: Transformation of substances

Contextual standard:

Chemical reaction, law of mass retention in chemical reactions, burning, combustibles, reactant, product, chemical decomposition,

chemical compounding,...

Performance standard:

- Differentiate between chemical and physical event
- Understand burning as chemical event
- Name examples of flammable and non-flammable substances,
- Explain the essence of extinguishing a burning substance
- Describe methods how to correctly extinguish fire of individual substances,
- Be aware and understand symbols of combustibles and flammables,...

Example of innovated standard:

Thematic unit: Transformation of substances

Performance standard:

Students

- Undertake simple experiments of chemical compounding and chemical decomposition following the guidelines,
- Name examples of exothermic and endothermic reactions familiar from daily life,
- Make measurement experiments of heat changes in chemical reactions,
- Record results of their experiments into tables and interpret them,
- Reason principles of fire extinguishing of substances based on examples from daily life,
- Follow principles of safe handling with flammables,
- Propose modelled experiment of fire extinguishing with teacher's assistance
- Execute and evaluate impact of various factors to speed of chemical reaction in experiments,...

Further selected examples of performance standard:

8th grade:

- Practically verify process, features, and results of neutralisation and oxidation reducing reactions,

9th grade:

- Make simple experiments to differentiate and identification of inorganic and organic substances,...

Contextual standard:

- Observation of chemical events (chemical reaction, reactant, product)
- Law of mass retention
- Chemical compounding, chemical decomposition
- Heat changes in chemical reactions (exothermic and endothermic reactions)
- Ignition temperature
- Flammables / combustibles

- fire,...

5.2. Educational standard of biology

Educational standard in biology was innovated in several areas.

In the area of goals related to “Human and nature”, formulation has been modified and reduced and both performance and contextual standards have been made more compact. Thematic units have also been partially modified. Proposal to swap curriculum between 8th and 9th grade is a large intervention into the state curricula. The aim of this swap is to allow smooth transition between thematic units and following logical sum up and generalization of curriculum about live organisms in the 8th grade. When curriculum on live nature is completed, the one dealing with inanimate nature follows in the 9th grade.

In the following section we introduce examples of former and proposed standards.

Example of the standard from 2009:

Thematic unit: Life in the woods

Contextual standard:

Life of the woods, Structure of woods, Year round changes in the life of woods

Forest trees, coniferous and deciduous trees, bushes, year round life of trees,...

Performance standard:

Mention examples of plants or animals living in the woods. Name layers of woods using a guiding figure. Describe changes in the woods across seasons of year. Compile and example of a food chain of organisms living in woods,...

Example of innovated standard:

Thematic unit: Community of organisms

Performance standard:

Students

- distinguish communities according to their representation,
- explain how do organisms adjust to their environment,
- reason food chain relationships between organisms living in a community,
- compile a single food chain for each community,
- formulate principles of safe behaviour in the woods and principles of health protection,
- accept principles of mushroom picking and collection of plants in nature,
- present their own output (posters, models, presentations),...

Further selected examples of performance standard:

6th grade:

- propose and record observations of selected invertebrate,

7th grade:

- find out what is happening inside human body when physically active (physical work),

8th grade:

- plan observation of basic signals driven by senses and basic processes of organisms in multiple ways,

9th grade:

- organise water protection and economising activities, or economising on energy use in their environment,...

Contextual standard:

- communities of the woods, water, fields, meadows,
- bacteria, mushrooms, plants, animals,
- food chain
- wood plants, trees, bushes, herbs
- outer structure of wood plants and herbs
- woods layers
- mosses and ferns
- outer structure of mosses and ferns
- sexual duplicity, nesting...

6. Conclusion

Changes in the framework curricula of lower secondary education related to time allocation of human sciences and proposed concept as such allow for more room to apply creative methods and forms of teaching, while active approach of students and research and experiment based findings are dominating. Experience with this method of teaching human sciences do document significant influence in development of students' competences as well as their critical thinking, problem solving, formulating hypothesis, argumentation and coherent conclusion upon their findings. [4,5,6]. This approach allows room for shifting the concept from deductive to inductive style of education.

Besides high quality programmes, division of classes guaranteed by state is also a factor to support the advance of new concept. This however incorporates another area of issues, which relate to necessary legal amendments.

We assume that proposed educational programmes of subjects within human sciences for lower secondary education will be approved and adopted as an integral part of state curriculum (including comments) by 1st September 2014.

9. References (and Notes)

- [1] Kratochvíl V. A look back (to the problem of innovation state educational programs). In: Association of Chemistry Teachers. Proceedings of the 1st International Conference of Chemistry Teachers; 2013; Banská Bystrica, Slovak Republic. Banská Bystrica: Matej Bel University; 2013. p. 12-16.
- [2] Lapitková V. Evaluate the performance of pupils in the reformed science programs. Prešov: Michael Vaška Publishing; 2011.
- [3] Yang BD. Current trends in the reform processes of science teaching. In: Proceedings of the Conference FAST-DISCO; 1996, Častá Píla, Slovak Republic; 1996. p. 18-29.
- [4] Ganajová M., Kimáková K., Ješková Z., Kireš M., Kristofová M.: Implementation of IBSE methods and teaching materials in science education in Slovakia. In: The 5th International Conference Research in Didactics of the Sciences: book of abstracts: 27th-29th June 2012. Krakov: Pedagogical University of Kraków, 2012; p. 43. ISBN 9788372717344.
- [5] Čtrnáctová H., Ganajová M., Šmejkal P., Kristofová M.: Inquiry-based activities in topics: polymers, plastics and plastic waste. In: The 5th International Conference Research in Didactics of the Sciences: book of abstracts: 27th-29 June 2012. Krakov: Pedagogical University of Kraków, 2012; p. 29. ISBN 9788372717344.
- [6] Ganajová M., Kimáková K., Ješková Z., Kireš M., Kristofová M.: The method of active research in science teaching In: Current trends in science teaching: Proceedings of the International Conference: 15th -17 October 2012, Smolenice. Trnava: Faculty of Education University of Trnava, 2012; p. 114-119. ISBN 9788080825416.



BLENDED LEARNING FOR SCIENTIFIC INQUIRY: RESEARCH EVIDENCE FROM A US CLASSROOM

Eva Erdosne Toth

eva.toth@mail.wvu.edu

Abstract. *Designing classroom learning environments that support the development of scientific understanding by way of experimentation and inquiry is a global concern for science teachers and science teacher educators. Due mainly to cost, time and safety factors, hands-on learning often results in a “protocol-based” activity where research questions, experimental design and methodologies to examine data are prescribed rather than actively invented by learners. Virtual laboratories that simulate real-life processes of scientific inquiry are powerful digital tools to overcome this economic hurdle.*

But can these tools replace hands-on-inquiry learning? What are best ways to integrate hands-on and virtual inquiry into classroom learning environments? These are the questions that this study was aimed to answer. This proposal for HSCI 2013 describes a study that employed two learning environments for inquiry. It used a third-party virtual laboratory (VRL) available on the internet and a hands-on laboratory (HOL) that is commonly available in the US for purchase classroom teaching. The aim of the study was to compare and contrast college students’ inquiry learning experiences with the two environments. With this method, the study aimed to contribute research data to support the instructional design decisions of practitioners aiming to develop learning environments with the blending of virtual and hands-on experimentation.

The participants of the study were 32 college students, in their first year of study of science at research and teaching focused private university in the United States of America. The study used a quasi-experimental approach for experimental design and used a mixed method approach that coordinated the collection of quantitative and qualitative data from the beginning of the work. The results illustrated the significant advantage of using virtual laboratories before hands-on experimentation as measured by students’ post-inquiry conceptual and procedural knowledge. Furthermore, the analysis also illustrated the

benefit of starting with the VRL as measured by students' inquiry progress score. In addition to detailing these findings, the presentation will also consider some of qualitative students' responses that illustrated differences in students' approach to the two different (virtual and hands-on) learning environments. For example, after working with the "real" (hands-on laboratory) some students felt that it was unnecessary to work with the "mere simulation" of reality and the virtual laboratory.

The significance of these results is that the data to be presented at HSCI 2013 supports the development of instructional design decisions for inquiry-based learning and teaching with the combination / blending of hands-on and virtual laboratory environments. The study has been successfully shared with science teachers and science education researchers in the US and the goal of sharing it at HSCI 2013 is to receive feedback from international colleagues towards the further refinement and development of the approach that may lead towards more generalizable information about the use of blended-learning across the globe. References related to this work have been omitted due to space constraints but will be shared at the conference.



PRESERVICE SCIENCE TEACHERS PERCEPTIONS ABOUT USING SCIENCE NOTEBOOKS: A COMPARATIVE INVESTIGATION OF UNITED STATES AND TURKEY SAMPLE

İlke Çalışkan

ilkeonal@hacettepe.edu.tr

Abstract. *Science notebooks are an effective formative assessment tool that allows teachers to assess students' understanding and provide the feedback students need for improving their performance (Ruiz-Primo, Li, & Shavelson, 2002, p. 24). The student science notebook serves as an important link between science and literacy when it is utilized in the classroom as a knowledge transforming form of writing that*

provides an appropriate opportunity for students to develop voice in the process of constructing meaning from their experiences with the science phenomena. (Klentschy and Molina-DeLa Torre, 2004; p. 352).

The aim of this research study is to find out the perceptions of preservice science teachers' about using science notebooks in their Science Teaching methodology course and make a comparative investigation of United States and Turkey sample.

The research design is based on qualitative methodology. Both Turkey and United States sample was chosen by purposeful sampling. United States sample was chosen from University of Iowa Science Education Center and consists of 20 third grade preservice science teachers and Turkey sample was chosen from Hacettepe University Department of Science Education and consists of 40 third grade preservice science teachers. From totally 60 preservice science teachers, 12 of them (six of them from United States and six of them from Turkey) selected by looking at their academic achievement and voluntariness. The process lasted fifteen weeks in both countries during Science Teaching Methodology course. Observation checklist, science notebooks and focus group interview questions were used as data collection tools. Observation checklist constructed by the researcher consists of ten semi-structured items which cover the tendencies and skill development processes during the usage of science notebooks. Science notebooks consist of four stages. First stage is introduction part and students state their expectancies about science teaching methodology course. Second stage is the student teachers' diaries about the general reflections about the course. Third stage is related to course qualifyings. Instructor gave critical thinking questions or a problem scenario and student-centered activities like constructing an experiment in this stage with the help of colorful materials. Student teachers adapt this materials into their science notebooks. Fourth stage covers the general assessment of the using science notebook process and course dynamics. Student teachers state reflections about the course, instructor and their own performances. Semi-structured interview consists of six open ended questions prepared by the researcher identify student teachers' perceptions about using science notebooks during their science teaching methodology course and their future implications. Document analysis, observation

and interview methodologies were used for describing qualitative data. Both descriptive and content analyses were used as qualitative data analysis techniques. Themes were identified by looking at related literature and corresponded with the codes coming from qualitative data. Triangulation was used for data analysis verification.

Results show that science notebooks are effective tools and instructional technique in teaching and learning environments for developing and assessing science process, problem solving and teaching-learning skills of student teachers. All of the student teachers claim that they plan to use science notebooks in their future science classrooms.



PRESERVICE SCIENCE TEACHERS EXPERIENCES WITH THE IMPLEMENTATION OF PROJECT BASED LEARNING

Dogan Dogan, Eylem Eroglu Dogan
ddogan@ibu.edu.tr

Abstract. The rapid developments in science and technology has greatly influenced teaching and learning process in education. Traditional science teaching relied mainly on teacher-centered teaching strategies such as lectures and questioning or teacher-led discussions and demonstrations. However, twenty-first century teachers are expected to facilitate the learning process through learner-centered, active teaching strategies. Project-Based Learning (PBL) is one of the learner-centered approach to teaching science and has gained much attention over the last few decades. It is a hands on and interactive approach that allow students to pose problems, ask questions, make predictions and decisions, design investigations, collect and analyze data, use information technology, share ideas (Krajcik et al., 1999), and take responsibility in building their own knowledge by active learning. Like other instructional approaches, PBL have also various advantages and disadvantages.

PBL is an innovative approach to learning that teaches a multitude of strategies critical for

success in the twenty-first century (Bell, 2010). Preservice science teachers of this new era are expected to know how to implement PBL in schools when they become real teachers. As for every science teacher, it is important to have the knowledge and experience of how to design and implement PBL in her/his science course. The purpose of this study, therefore, is to examine preservice science teachers' experiences in implementing the PBL during their teaching practice in application schools. The course, in which the research was carried out, is a one-semester elective course and is part of the students' teacher training in primary science education. The study is based, mainly, on qualitative content data analysis strategy. A variety of data collection methods is used to inform the results of the study. The interviews, observations, and artifacts were used to characterize the preservice teachers' implementation of PBL in the classroom. Implementations were assigned a score based on a rubric developed by the authors. The use of multiple methods helps to triangulate the data and confirm the findings and interpretations. The participants consist of 30 science teacher candidates who are in their last year of a primary science teacher education program in a large public university in Turkey. They were informed that participation was voluntary, and informed consent was obtained from all those who volunteered to participate. The results of the study are expected to contribute to the current literature about PBL and the improvement of pedagogy in science teacher education.



IMPROVING THE SCIENTIFIC PROCESS SKILLS OF ELEMANTARY PROSPECTIVE TEACHERS THROUGH HANDS ON SCIENCE PRACTICE: AN ACTION RESEARCH STUDY

**Necati Hirça, Mücahit Köse,
Muhammet Uşak**
dr.hirca@gmail.com

Abstract. The purpose of this study is to improve the scientific process skills of elementary prospective teachers through hands

on science practice. This study is implemented based on action research methodology. Both qualitative and quantitative approaches were used in order to better understand how students can develop scientific reasoning skills in the science classroom. The participants of this study were thirty-nine elementary prospective teachers enrolling to the “Science Laboratory Applications (SLA)” course. The main goals of the SLA course are identified as; a) to specify importance of laboratory in science and technology instruction, b) to explain relation between constructivist approach and laboratory works, c) call attention to safety in laboratory, d) to explain scientific method, scientific process skills and how they were gained and e) to design simple experiments for first level of elementary education (planning, conducting an experiment and evaluating the results). On the other hand, the researcher incorporated the aim of the course into hands on science experiments including scientific process skills in the next seven weeks. He informed students-teachers about “Hands on Science experiment” and showed a simple experiment which can conduct based on SPS in fifth week. Three different methods were used to collect data from students during the semester: open-ended questionnaire, lab reports, and surveys.. In order to analyze quantitative data, descriptive, reliability analysis and correlation analysis were used. On the other hand, qualitative data was analyzed using qualitative techniques.

As a result of the analysis of the collected data, findings emphasis the importance of hands on science practices for improving the scientific process skills of elementary prospective teachers. Pre-service teachers have been thought they gain ability of providing material, transferring theoretical knowledge into practice, responsibility and creativity for experiment from the course, student teachers’ perceptions about conducting experiments turned out to be fun and they have positive opinions about the use of hands on science within their classrooms.



AN EXAMPLE OF INTERDISCIPLINARITY: PHYSICS, CHEMISTRY AND MATHEMATICS MERGE WITH BIOLOGY AND GEOLOGY IN AN URBAN FIELD TRIP

Lídia Guimarães, A. Mário Almeida,
Ricardo Rodrigues dos Santos,
Manuel F. Costa
mfcosta@fisica.uminho.pt

Abstract. Given the interdisciplinary importance constructing knowledge in science teaching, this is over more efficient as the application of diversified strategies of teaching. The fieldwork is a strategy used generally in Biology or Geology; however, this work shows the possibility of applying the same strategy in different scientific areas, such as Physics, Chemistry and even Maths. An urban path was first idealized and each point stop treats different science matters. In addition, the cross linking of scientific areas taken to the social field reinforces a wider construction of knowledge over a greater number of natural phenomena. The fieldwork proposed in this document was planed in three different groups: the historic centre city of Braga, the river that passes through the city (river Este) and its unspoiled green forest park (Bom Jesus do Monte). For each of the chosen locals were defined the point stops based on some of the most important landmarks of Braga (figure 1). After a first visit to the field, with an open science eye, the themes choice were carefully decided based on time and places that permit the execution of a walking through path plan. The starting point being the sound produced by church bells in the centre city as the motor to investigate the conditions of production, propagation and reception of sound, the human ear and the functioning of a sound level meter. The calculation of areas, the drawing of circumferences, arcs and ellipses, as well as the equilibrium involved in the sustentation of an arc, the calculus of the circles area with the knowledge that there is an uncertainty when measuring at the local point of the fieldwork, the eye that questions symmetries and the “protection shield” against pigeons preventing architectural deterioration where themes

suggested when one experiences Braga's urban field.

Walking by the river come to mind the hydrologic cycle, superficial tension, pH, the microscopic life in a water drop and the functioning of a microscope.

A brief characterisation of the fauna and flora is given when in the forest park (Bom Jesus do Monte). The greenhouse effect, the evolution of the atmosphere, photosynthesis and carbon-14 dating are also important subjects. Up the mountain using the hydraulic elevator brings to mind the Law of Conservation of Energy and renewal energies. The surroundings at the end of the walk suggested themes like Arquimedes Principal, the uses of lightning arresters and the GPS system that guided through the point stops coordinates of the course path.

The work required preparation of subjects, collecting samples, data and imagery, essential resources for the fieldwork post-analyses. The gathered material is subjected to observation, numeric calculus and laboratorial work, presenting results to discussion.

Information documents were produced, such as flyers (figure 2), fieldwork guide and a question box to evaluate the public experience throughout the fieldwork.



IS IT NECESSARY A FORCE FOR AN OBJECT TO MOVE?

Alcina Rito, Rui Vila-Chã,
A. Mário Almeida, Manuel F. Costa
mfcosta@fisica.uminho.pt

Abstract. We present an activity for the 11th grade designed to question and learning the Laws of Newton.

As the first task students will answer a quiz to evaluate their knowledge about acceleration and the first and second Laws of Newton. After that an experimental task will consist of moving a small car on a horizontal plane using a falling block. The string connecting the small car and the block will be long enough to enable the block to touch the ground before the car stops against a bumper (Figure 1). The friction will be considered small enough to be disregarded.

The experiment will be recorded by a video camera and images will be analyzed by the computer program "Tracker Video Analysis and Modeling Tool". This program allows students to analyze the movement of the small car before and after the block touches ground, namely: the variation of velocity in time; acceleration; the net force applied on the small car; the ratio between acceleration and the net force; the different types of motion.

With the data collected in the movement analysis, students will answer another quiz in which they will perceive how their previous knowledge on the subject was accurate or not and how much have they learnt with this experimental activity in classroom.



EXPERIMENTS IN SCIENCE AT PRIMARY SCHOOL

Jitka Houfková, Dana Mandíková,
Zdeněk Drozd
jitka.houfkova@gmail.com

Abstract. In our workshop we introduce two selected topics – Air and Water - from seminar designed for pre-service primary school teachers. Primary school teachers are the first ones in the school attendance who introduce pupils to the natural science. Thus it is very important to gain their interest and to motivate them to future studies. Young pupils are very inquiring, they want to know how things work and they love to do experiments. Our seminar provides the opportunity to familiarize the future teachers with experiments from the parts of natural science that are taught at primary school and give them an opportunity to try them themselves. The emphasis is put on hands-on activities of the future teachers and on self-production of simple teaching aids, as well as on correct explanations of shown phenomena and on ways how to present them to young pupils, and most common misconceptions are mentioned, too. The participants of our workshop will have an opportunity to try set of experiments from the selected topics – Air and Water, and make their own teaching aid



WHAT HAPPENS NEXT?

David Featonby
featonby@onetel.com

Abstract. *WHAT HAPPENS NEXT?* is a workshop consisting of demonstrations several experiments often with discrepant outcomes. The strategy, which will be explained, can be adopted with almost all ages, with students and teachers, to both engage them, challenge their thinking skills, and entertain. A short experiment is explained and set up, and then the action is paused for the audience to discuss the outcome. The workshop covers several areas science, particularly physics,, - for example most areas of mechanics, light, and heat. Participants in the workshop will have access to a bank of over 60 separate ideas which can be used in teaching. The ideas of the work shop have been presented throughout the UK and in Europe, both personally by David Featonby and through colleagues of Science on Stage. David also writes a regular column for Physics Education on the subject. In the UK the strategy has been used in general science teaching, at parents meetings, for end of term quizzes, and as preparation for university and industrial interviews. The workshop will challenge, entertain, and surprise and without doubt provide material that will be used by participants teaching situations.



SECRET LIFE IN AN AQUARIUM FILTER

Jan Mourek, Barbora Talavášková
mourek@natur.cuni.cz

Abstract. *Freshwater aquarium may serve as a nice and relatively simple educational model of water ecosystem functioning, which can be observed directly in school classroom. In aquarium, we can easily demonstrate basic ecosystem compounds and several trophic levels. The light source is represented by aquarium lamps, the secondary producers by water plants and algae, secondary producers (consumers) by water snails and fish. The consumers' food source is supplemented e.g. by the artificially added fish feed. An essential, but much lesser known part of the aquarium system is the assemblage of mostly microscopic decomposers, transforming organic debris into inorganic compounds serving as plant nutrients.*

In this microscopic laboratory workshop we will make a short biological expedition into a fascinating and diverse community of organisms inhabiting aquarium filters, which can be easily observed by conventional biological microscopes. A droplet of the detritus squeezed from the filtering sponge may contain up to several dozens of species, including different groups of protists and invertebrate animals. The protists are represented mostly by various flagellates, diatoms, ciliates, naked or testate amoebas and heliozoans, whereas the multicellular animals (Metazoa) by microscopic planarians, nematodes, rotiferans, gastrotrichs, oligochaets, mites or crustaceans. The main advantage of this rich source of biological material is that it can be very easily obtained and is available throughout the whole year for school observations.

Our main aim is to introduce the participants into the identification of main groups and typical representatives of filter inhabitants with simplified identification keys. Further, we will observe the behaviour of these organisms, such as types of movement, feeding strategies and escape reactions. Finally, we will provide several proposals of short term laboratory tasks as well as long term school projects focusing on the inhabitants of aquarium filtration systems.



Digital Technologies in education

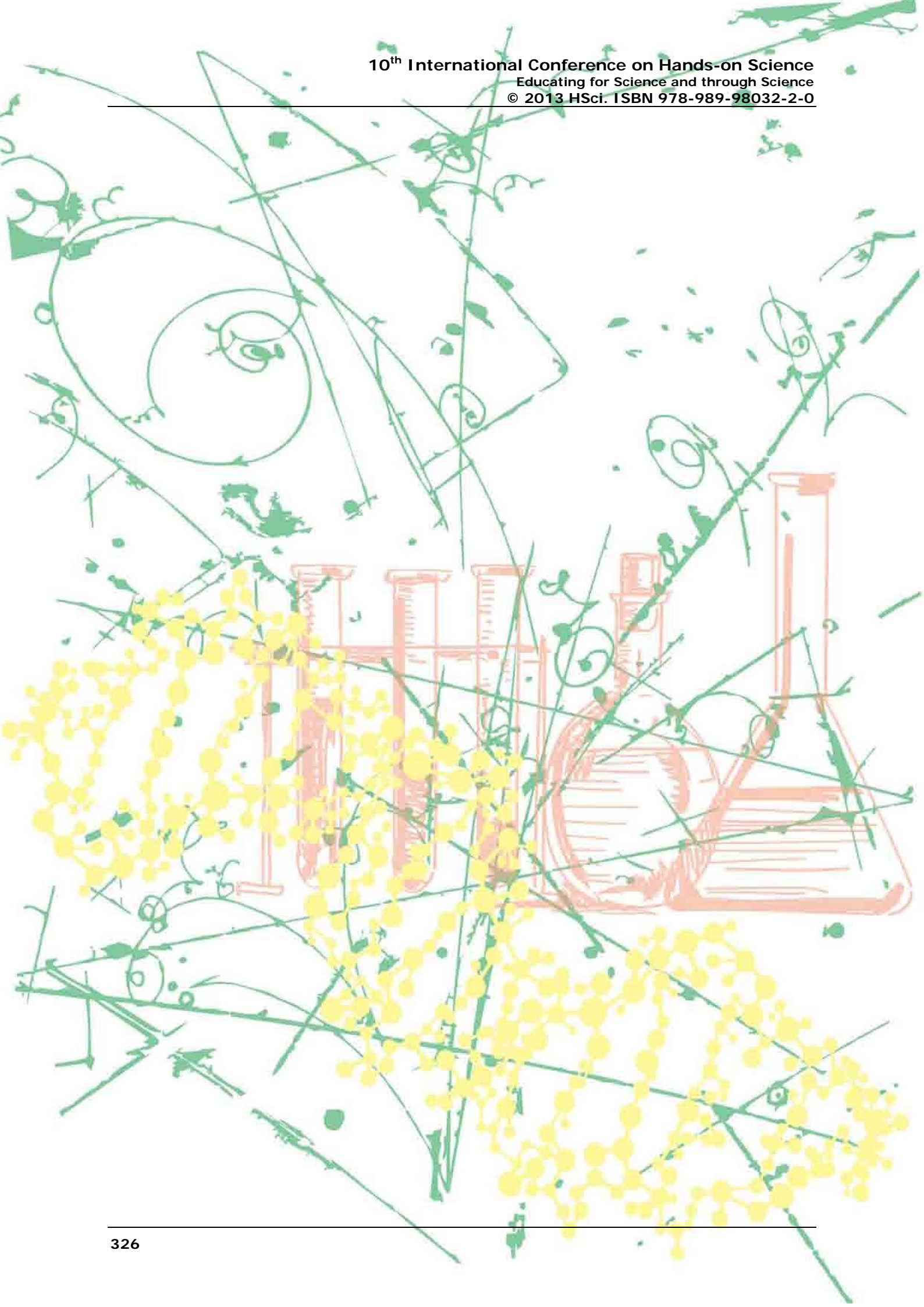

THE CARTOON GUIDE TO RELATIVITY

Jan Novotný, Jindřiška Svobodová

The Faculty of Education, Masaryk

University Brno, CZ

novotny@sci.muni.cz,

svobodova@ped.muni.cz

Abstract. *This paper describes an ongoing project to build a multimedia application that presents Einstein's theory of relativity in a cartoon environment. This article argues for the use of the cartoon animation form in science education for future teachers. Several examples from Theory of Relativity in our "Cartoon Guide to Relativity" present the ways in which that form can enhance science explanation. While further wider research may be needed, this article seeks to find the groundwork for a basic science education in attractive form that shows science in action and engages student's awareness of scientific development.*

Keywords. Courseware, physics education, special relativity

1. Introduction

Special Relativity is often featured in introductory physics courses, many students are looking forward to those lessons. They often have high expectations for this topic, but soon they turn that the understanding Special Theory of Relativity is quite difficult task in practice.

Special Theory of Relativity (STR), while mathematically simple, deals predominately with situations outside everyday experience. Modifying everyday concepts of motion, time and space and replacing them by precise constructs of STR represents a difficult task for everybody. The theory of relativity attracts extraordinary attention of inquiring public.

Every physicist probably had met with its insistent critics who claim that STR leads to the absurdities. Physics teacher should be able to vindicate the theory at least for himself (because an effort to convince is usually fruitless). This ability to oppose the critique represents a touchstone in understanding STR.

The open textbook "Special Theory of Relativity 2005" as downloadable PDF course material for

students was prepared several years ago [1], [2]. This textbook is still quite popular among physics students. The carefully structured text and number of explanations make that educational material is suitable for a self-study.

The authors have developed set of cartoon-style multimedia animations illustrated STR [3]. It was simply titled The Cartoon Guide to Relativity.

Basic terminology, key ideas and STR experiments are appearing on background story alien adventures. Every animation is narrative, combining story-telling and visualization. These stories enable to explore some relativistic effects without requiring a detailed understanding of the theoretical framework.

Much of the material is at a level suitable for high school students. This approach is designed for those students who desired better understanding the special theory of relativity, focusing on the concepts and results.

One or more animations can be integrated into every aspect of a course STR. Students who watch selected animations in lecture, then take an assessment quiz. We have found be useful to do a short interview with student, too.

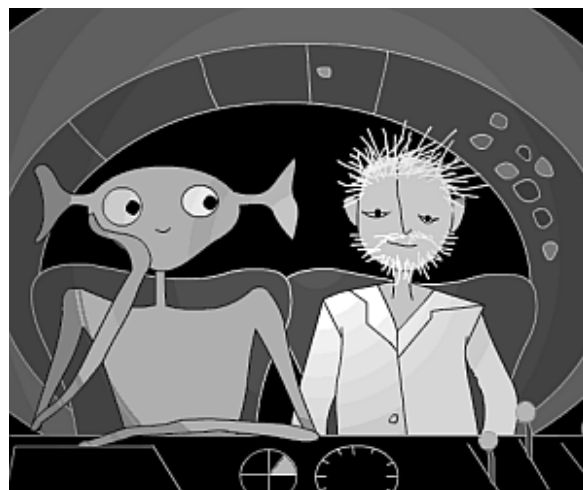

Figure 1. Alien and Professor - main protagonists

2. Cartoon Animations in Course STR for Future Teachers

The main characters Alien and Professor are guides through particular manifestations of STR ideas that are away from common sense. The story begins meeting an Alien (from an advanced civilization that STR applied in everyday practice) and Professor of theoretical physics.

Alien traveling at high speed rocket informs Professor of his observations. All measurements and observations of natural phenomena are based on determining the spatial and temporal relations.

Step by step they formulate the basic postulates of STR in their communication.

- I. All physical laws have the same form whatever constant velocity you are moving.
- II. The speed of light is always the same, independent of the motion of the observer or light source.

Now, we describe several samples from our animation collections, listed below, with a brief description of its, we are using for this course STR.

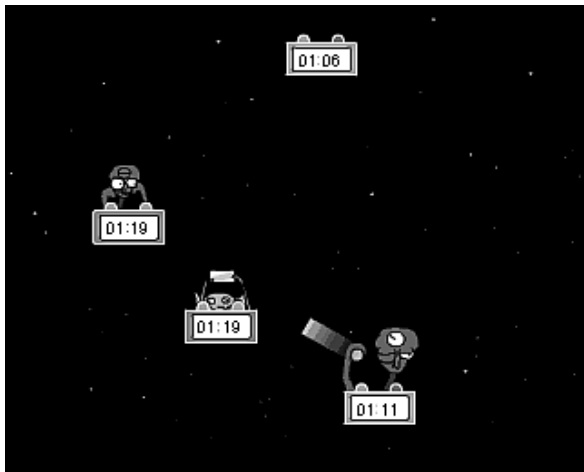

Figure 2. Synchronisation method

2.1. Science Terms

A conversation between Alien and a Professor begins by clarifying their terminology. The "event" means something quite specific in the context of STR: an event is something which happens at a single point in space at a single instant in time. The area of physical processes is a space-time, its elements are events.

The processes in space-time are described from point of view of different frames of reference (we restrict ourselves on inertial systems of reference). Reference frame is idea of great importance. Key feature of both classical mechanics and STR is that no uniquely privileged reference frame exists.

Any rigid non accelerating body may be regarded as a realization of the valid reference frame. In usual presentation of STR we restrict ourselves on inertial systems of reference (systems where the law inertial holds).

Then Alien explains a meaning of a word proper length to Professor. In classical mechanics, lengths are measured based on the assumption that the locations of all points involved are measured simultaneously, but in STR the notion of simultaneity is dependent on the observer. Proper length between two separated events is the distance between the two events, as measured in an inertial frame of reference in which the events are simultaneous.

Proper lengths provide an invariant measure, whose value is the same for all observers.

2.2. Synchronization

There is a new problem - synchronizing clocks at different points of space. In the course of analysis of the rocket motion the problem arises, how to determine simultaneous location of ends of rocket. A necessity turns out to synchronize distant clock. Alien presents to Professor his method of synchronization which in fact corresponds with Einstein's method of exchange of light signals.

2.3. Composition of velocities

The classical composition of velocities contradicts to the relativistic postulate of invariant velocity of light. Alien assign a task to Professor. You are monitoring a space ship moving away on Earth. If I am going at $0.5c$ relative to you and the rocket goes $0.5c$ relative to me how fast will it go relative to you?

The results for classical and relativistic composition are presented.

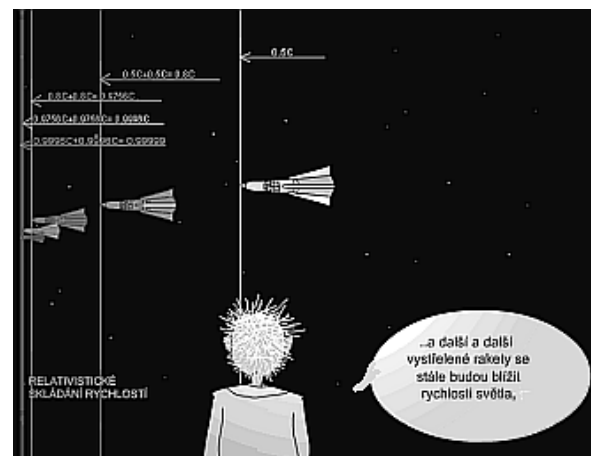

Figure 3. Adding velocities

2.4. Time Dilation

Alien shows to Professor how relativity implies time dilation and length contraction. When object moves with relativistic speeds a "strange" thing seems to happen to its time as observed by "us" the stationary observer (observer in an inertial reference frame).

In this story what we see happen is that the "clock" in motion (in train) slows down according to station clock, therefore we read two different times. Which time is correct? Well, they both are because time is not absolute but is relative, it depends on the reference frame.



Figure 4. The effect of time dilation

The concept of simultaneity is analyzed in the case of door opening in the train moving with great velocity. It is demonstrated that relativistic simultaneity depends on the choice of reference system.

2.5. Length Contraction

The dilatation of time, length contraction and they connection is represented here.

Professor performs length contraction experiment with goat having a regular metabolism. He discovered that the length of object in a moving reference frame will appear foreshortened in the direction of motion, or contracted.

It is shown that length between "marks" - goat droppings is maximal from point of view of professor's system of reference, whereas time interval of goat "marking" is minimal in the rocket system of reference.

2.6. Twin Trip

The twin paradox uses the symmetry of time dilation to produce a situation that seems paradoxical.

The twin paradox is demonstrated as a story of two brothers born in the same time. The brothers go, one by one, the same cosmic travel and their biologic ages are contemporary separated and united again.



Figure 5. Professors attempt to measure length contraction



Figure 6. The twin traveling begins

3. Evaluation

Continuous evaluation of textbook helped to identify implications for future directions. The students were satisfied with the reading level of a textbook and they welcomed further multimedia enlargement.

The STR animation supplement is still evaluated through a combination of observation, interview and peer review. Besides, during semester students have completed surveys before and after

performing multimedia animations. Students are required to watch selected animation (may be repeatedly) and then complete a series of test questions. At the end of every course, students solved simple problems from this field.

In preparation for next semester the main features will be evaluated through peer review and with student test groups. Throughout the semester pre-tests and post-tests will be implemented to supplement the surveys and observations.

4. Conclusions

The students, who have undertaken cartoon multimedia stories, have reported benefits in their understanding STR phenomena. They appreciated better visual representation for relativity ideas.

In further refinement of these textbook and improved cartoon animations, authors will work on suggested modifications, worksheets and instructor notes of activities. They will introduce more explicit training documentation for STR tutors.

Next research is now focusing on analysis the correlations of acquired student's skills to other topics (geometry, attentiveness). Pre-test and post-test of students will provide an overview of the student's concept development when experimenting with STR animation.

5. Acknowledgements

Support for this study has been provided by EP project OPVK Moduly jako prostředek inovace v integraci výuky moderní fyziky a chemie reg. č.: CZ.1.07/2.2.00/28.0182.

6. References

- [1] Novotný J, Jurmanová J, Geršl J, Svobodová M. (2006) Základy teorie relativity. Elportál, Brno
- [2] Jurmanová J, Novotný J, Geršl J (2006) Multimedia CD Úvod do speciální a obecné teorie relativity. Scientific Pedagogical Publishing.
- [3] STR Cartoon Project Website http://www.ped.muni.cz/wphy/C_R/cr.html
- [4] Visualized Space Time Travel <http://www.spacetime.travel.org/tompkins/>



ASSESSING THE ROLE OF SOCIAL NETWORKS IN INCREASING INTEREST IN SCIENCE AND SCIENCE LITERACY AMONG A SAMPLE OF FACEBOOK USERS

Bisan Battrawi, Rami Muhtaseb

Walid & Helen Kattan Science Education Project – Qattan Centre for Educational Research and Development – A.M. Qattan Foundation, Ramallah-Palestine

bisan@science.qattanfoundation.org,

rami@science.qattanfoundation.org

Abstract. *Many researchers are exploring new opportunities in education through employing social networks. Social networks may play an important role in science education since they expose information in a minimal amount of time. The Facebook page, Creative Minds was created in an attempt to popularize science in Palestine. This paper aims at evaluating the role of social networks in increasing interest in science and science literacy where 'Creative Minds' is taken as a case study. The effectiveness of 'Creative Minds' was assessed using an online questionnaire. The results present implications for educators on the use of social networks in enhancing science literacy.*

Keywords. Informal Science, Science Education in Palestine, Social Networks, Science Literacy.

1. Introduction

Since the rise of modern science in the 1600s, there has been an interest in linking the academic sciences to the lives of students and communities [3]. Science literacy has become an essential component of modern citizenry due to the direct connection of sciences to politics, economy and the society [10]. Moreover, Laetsch (1987) argues that science literacy has become an important indicator of development as it enables better political decisions and economic returns, helps reduce superstition, improves individual behaviors, and helps create a more ethical world (as cited in [6]; [7]). Achieving science literacy, however, remains to be a challenge, as sciences are usually communicated to the public in a less

appealing way and are conveyed in an esoteric language known only by the experts in sciences. The rapid increase in the use of social networking tools coupled with the availability of various access methods present a great potential for enhancing collaboration between people. This could present a great investment for education and research. Social networks have transformed the use of internet from a solely information access tool, to an interaction tool used by individuals to discover and share content, opinions, and information [2].

Science education may involve the interaction between the four communities; society, students, educators and scientists, as illustrated in figure 1:

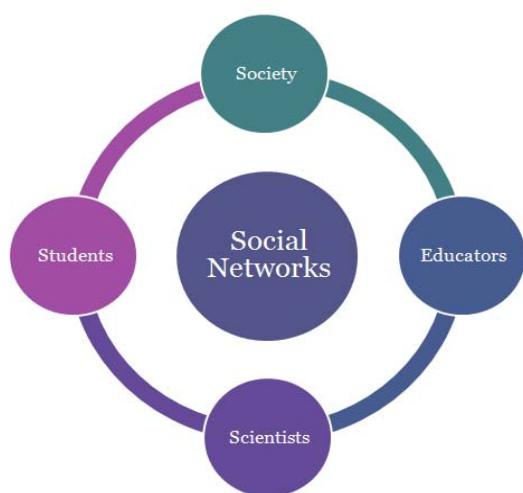

Figure 1. Connecting communities through social networks (illustrated for science education)

In science education, there is a vital need for an effective interaction between the four communities; students, educators, scientists and society, as science is linked to all aspects of the everyday life. Social networks engage students in learning processes and support interaction among students, instructors and their communities [4]. Recent arguments suggest that social networks possess many desirable qualities of good and 'official' education technologies, where feedback and matching social contexts of schools, universities and local communities are permitted [8] [9]. The properties of social networks allow for collaboration and active participation in generating knowledge among the users [8]. Nowadays, an increasing number of scientists are becoming active on social networks where people can follow the scientists and have their immediate comments and feedback on different scientific events, discoveries, and updates related to their field of work. Kateman (2012) [5]

suggests that scientists in the digital age have a unique opportunity to communicate and interact directly with the public on social media platforms in an engaging, casual and fun atmosphere.

Social networks may also play an important role in science education by leveraging the crowdsourcing for scientific events, since they encourage interaction and contribution. This has encouraged many educational institutions to adopt learning communities; where researchers can generate online discussion from the confines of their labs; curators can promote knowledge displayed within a museum; and teachers can create an exciting environment for their students to learn science [5].

1.1. Science Education in Palestine

Science education in Palestine remains to be traditional where the students' role is limited by the textbook-driven lectures, and their performance is evaluated based on their knowledge of the textbooks [13] [14]. This challenge, coupled with the general lack of interest in science and science culture among the Palestinian society, inhibits the students' and society's interest in science as it is seen as a rigid topic with minimal hands-on experimentation [14]. Science literacy is very important, yet achieving it remains to be a challenge; however, developing informal science learning environments could be effective in enhancing science literacy in Palestine [7].

The Walid and Helen Kattan Science Education Project (WHKSEP), is a Palestinian project aiming at "improving the quality of science education in Palestine's schools and effectively transmitting its value into the wider society" and is making many efforts to improve science education both on educational and societal levels; this involves its informal science program which aims to immensely contribute to enhancing science culture and literacy in Palestine [13].

1.2. The Employment of Social Networks

Social networks have been used for various educational purposes including peer-learning, teacher-student discussions, and scientist-public interactions. Educators may soon reach a point at which it is difficult to imagine education without social networking tools [15]. Furthermore, involving students with discussions on science-

related topics is of a great importance, not only with other students and teachers, but also with the public and the scientific communities.

Emphasizing informal science learning activities and communication could be of a tremendous advantage when attempting to raise awareness about and interest in science and science culture in the Palestinian society [7] [13]. Battrawi and Muhtaseb (2013) suggest that social networks could be employed in science education as they create a virtual space for informal learning of science where students and the general public may learn valuable scientific knowledge, interact with each other on science-related topics and share scientific knowledge [4]. Moreover, social networks could be useful in tackling issues in science education, such as common misconceptions in science, as they can reach and affect the society as a whole [4].

In order to create virtual communities and encourage the active participation of social network users, social networking sites need to provide means and tools to support interaction and collaboration. The number and availability of social networking tools has expanded to include various online activities such as webcasting, blogging, instant messaging, chatting, and gaming [12]. In Facebook, fan pages are among the tools that are designed to help user connect with other users based on common interests. Active participation can be emphasized using fan pages as they are innately designed to facilitate interaction.

Evaluating the impact and the role of social networks in promoting science literacy and interest in science, allows educators and social networks' developers to observe the important issues needed to be considered while adopting such tools in order to make the best use of them for educational purposes. The purpose of this study is to evaluate the impact and the role of social networks in increasing interest in science and science literacy in the fields of science, technology, society and environment (STSE) using the Facebook page 'Creative Minds' as a case study. To achieve this purpose, the effectiveness of the Facebook page 'Creative Minds' was assessed by a group of its audience using an online questionnaire, where two themes with different subtopics were selected and evaluated:

Theme 1: The exploration of the extent to which the page 'Creative Minds' is increasing interest in science among the audience; where the following aspects are discussed:

- Evaluation of the page's content
- Audience's engagement in science culture

Theme 2: The assessment of the role of the page 'Creative Minds' in promoting awareness about current and ongoing issues in science; where the following aspects are discussed:

- Audience's identification with the scientific community
- Connection of science to the daily life
- Awareness about and responsibility towards current and ongoing scientific and environmental issues.

2. 'Creative Minds' Facebook page

The 'Creative Minds' Facebook page is a bilingual Facebook page where Arabic and English are the languages used. The Walid & Helen Kattan Science Education Project created the page in February, 2012 in an attempt to popularize science in Palestine, promote awareness about citizen science, provide people with resources and updates related to science, encourage critical thinking and questioning, raise people's interest and awareness about specific topics in science, refute common misconceptions in science, and present a venue for interaction between people on science-related matters [4]. The current number of page fans is 3,038.

The unique properties of social networks and particularly Facebook make them a great medium for educational interventions. The ease of access to Facebook, coupled with its popularity among Palestinian users, was the main factor influencing the WHKSEP's choice of Facebook as a medium of intervention.

Creating an interactive scientific learning environment by encouraging people to participate in positive content-related discussions is another goal of the page. 'Creative Minds' introduces people to reliable science news resources; encouraging people to look critically at their sources of knowledge and to collect and share useful information on the page.

The page also aspires to introduce and, in the future, promote citizen science. Through interacting with the 'Creative Minds' Facebook page, the Palestinian public involved is exposed to such projects and initiatives. This "awareness stage" will be elevated to "active involvement" in citizen science projects which will be established for educational purposes [4].

The page also attempts to link the audience to the current and ongoing international and global causes, events, petitions, and competitions in order to create global awareness and connection of Palestine to the international science community. This is of a special importance due to the lack of resources on such content in Arabic. The page also supports the WHKSEP's informal science program by following up with the students involved in the program's activities thus sustaining their interest in specific topics in science [4].

3. Method

The impact and the role of social networks in increasing interest in science and science literacy is dependent upon the perceived value of their use which is determined by the user. It may also be influenced by the previous level of interest and scientific knowledge among the audience. In order to evaluate the impact of the page in raising interest in science among the audience, an online questionnaire has been employed.

3.1. Participants

The online questionnaire targeted the audience of the 'Creative Minds' Facebook page. The participant evaluators were from different ages and locations. The total number of participants in this questionnaire was 60 among them 36 were male and 24 were female. The respondents were from 16 different countries, 54 respondents were from Arabic-speaking countries, 26 of which were from Palestine. Of the respondents, 20% were between 14 and 20 years old, 37% between 21 and 26 years old, 28% between 27 and 32 years old, and 15% were over 33 years old, while the average age is 26 years old.

The main characteristics of the 60 respondents are presented in Figures 2 and 3.

3.2. Procedures

The data for this study were collected using an online questionnaire. An invitation to participate in the study was posted multiple times on the 'Creative Minds' Facebook page. Participants were asked to 'check' the response that best described their level of agreement with the statement.

3.3. Research Instruments

The questionnaire included 22 close-ended questions designed to evaluate users' opinions on the impact of the 'Creative Minds' Facebook page on their interest in science and their level of science literacy. The design of the questionnaire involved a literature search to consider the best possible type of questions that reflect the users' evaluation of the page's content in terms of interest and literacy. The final questionnaire was a Likert-type bilingual questionnaire (where the languages used were Arabic and English) and included 4 parts: demographic data, evaluation of the page's content in terms of interest in science, evaluation of the page's content in terms of science literacy, in addition to a section that investigated the preferred fields of interest and preferred methods of content communication among the audience.

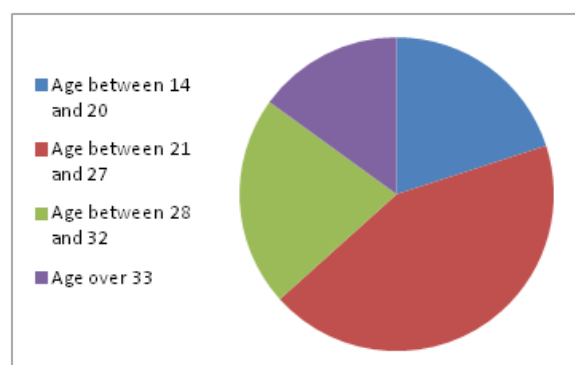

Figure 2. Ages of the participant audience in the study.

4. Data Presentation and Analysis

This study assesses the role of the page 'Creative Minds' in increasing its audience's interest in science and science literacy. To achieve this purpose, respondents were asked to indicate the level of agreement with several statements using a five-point Likert-type scale ranging from *strongly disagree* (1) to *strongly agree* (5). The participants were first asked a few general background questions, such as their age, their nationality, and the frequency of using Facebook. In terms of the frequency of using Facebook, a vast majority of respondents use Facebook multiple times a day, results show that 37% of the respondents use Facebook multiple times a day using computer and mobile device, 36% of the respondents use Facebook multiple times a day using computer, and 15% of the respondents

use Facebook at least once a day. This highlights the importance of employing social networks for educational and research purposes as they are becoming a part of peoples' every-day lives.

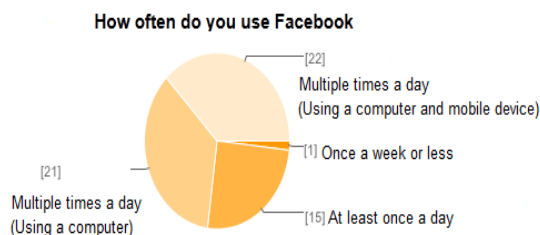

Figure 3. Audience's frequency of use of Facebook

As mentioned previously, two themes were highlighted in the questionnaire, each having subthemes with corresponding statements. Table 1, summarizes the cell means for the respondents' evaluation of the page according to the themes.

Audience Perceptions	
Theme 1: Interest in Science	Evaluations
Evaluation of the page's content	
Statement 1: New Knowledge	3.9
Statement 2: Quality of Topics	3.75
Statement 3: Quality of the Content	4.02
Audience's engagement in science culture	
Statement 4: Sharing Inside/Outside the Facebook Context	3.23
Statement 5: Interest to Participate	2.76
Theme 2: Awareness about Current and Ongoing Issues in Science	
Audience's identification with the scientific community	
Statement 6: Joining Science Events	3.33
Statement 7: Following External Resources	3.33
Connection of science to the daily life	
Statement 8: Connecting Science and Technology to the Society and Environment	3.45
Statement 9: Relating Science to the Everyday Life	3.35
Awareness about and responsibility towards current and ongoing scientific and environmental issues	
Statement 10: Feeling Up-to-Date with the Latest Developments and	3.43

Challenges	
Statement 11: Responsibility Towards the Environment	3.08

Table 1. Cell means for the respondents' evaluation of the page

4.1. Theme 1: The Extent to Which the Page 'Creative Minds' is Increasing Interest in Science among the Audience.

- Evaluation of the page's content

This part of the questionnaire included three statements related to the quality of the page's content, and the type of information conveyed in the page's posts;

- Statement 1: The page exposes me to topics in science which I am normally not exposed to.
- Statement 2: The page 'Creative Minds' posts interesting pictures, videos and interactive applications, I am always interested in reading/viewing the new posts.
- Statement 3: I find the topics demonstrated by the page very interesting.

By evaluating statement 1, the respondents evaluated the type of topics that are presented on the page compared to the topics that they already know about. The mean score of the audience's responses to this statement is 3.9. The mean score of the evaluation of statement 2 is equal to 3.75. Responses to this statement suggest that a large portion of audience appreciate the way the content is presented, which also highlights the importance of communicating scientific content in a simple and understandable way that reaches everyone despite their level of science literacy. The respondents agreed to the statement 3 with mean score 4.02 which indicates that most of the respondents are satisfied with the type and quality of the content posted on the page.

- Audience's engagement in science culture

In this section of the questionnaire, the statements are designed to assess the audience's level of identification with and engagement in the science culture. The statements assess the impact of the page's posts on the audience's engagement in science topics inside the Facebook context, through assessing their involvement in science-related discussions on Facebook, and outside the Facebook context, through assessing the extent to which the respondents reach in sharing and discussing the

page's content with their families, friends and communities. The statements used were;

- Statement 4: I feel interested in sharing some of the page's posts on my wall or telling my family and friends about those topics.
- Statement 5: I read the comments on some of the page's posts and feel interested to write comments or participate in discussions on the page.

The mean score of the respondents' evaluation to statement 4 is equal to 3.23, and to statement 5 is equal to 2.76. As mentioned in section 3, one of goals of 'Creative Minds' page is to present a venue for interaction between people on science-related matters and to encourage people to collect and share useful information. The responses indicate that most of the respondents were not interested or felt neutral about their willingness to get involved in science-related discussions inside or outside the Facebook context.

4.2. Theme 2: The Role of the Page 'Creative Minds' in Promoting Awareness about Current and Ongoing Issues in Science

- Audience's identification with the scientific community

This part highlights the role of the page in changing the audience's identification with the scientific community through assessing the audience's level of participation in ongoing and current scientific events, and the level of appreciation for reliable and trustworthy resources of science news. Two statements were used in this section;

- Statement 6: The page encourages me to participate in current and ongoing international science events (such as earth day, meteor showers, etc.).
- Statement 7: The posts on 'Creative Minds' make me interested in reading more about some topics from the provided links, or other external resources.

Responses to statements 6 and 7 are averaged as 3.33 for each statement. This indicates that a low number of the respondents agree with those statements, which might be due to the lack of scientific events that can be covered online, in addition to language being an additional barrier as most of the live streaming for the scientific

events was in English whereas most of the respondents were native Arabic speakers. However, elevating the audience's level of identification with the scientific community is a challenge which can be tackled with the effective and long term use of social networks for this purpose.

- Connection of science to the daily life

In this part, the respondents were asked two statements which assess the extent to which the page has helped the audience relate science to their everyday lives and contexts;

- Statement 8: The page helps me connect science and technology to the society and environment.
- Statement 9: The page has helped me in relating science to my everyday life.

The mean score of the respondents' evaluation to statement 8 is equal to 3.45, and to statement 9 is equal to 3.35. Statement 8 aims to assess the extent to which the page helps the audience connect science to the societal and environmental issues of today's world, while statement 9 assesses the extent to which the page is helping in connecting science to the daily lives of the respondents at home, work, school, etc. The mean scores of responses to both statements suggest that the respondents felt neutral towards these statements. This might be due to the diversity of the audience where some of them might have just recently become involved in the page. In order to achieve a better assessment to this statement, there is a need to study the long term effect of the page. However, connecting science to the daily life requires time and continuous exposure to knowledge which might be a limiting factor in this study.

- Awareness about and responsibility towards current and ongoing scientific and environmental issues.

Two statements were used to assess the page's role in changing the audience's levels of awareness about the current scientific and environmental issues, and responsibility towards such issues;

- Statement 10: Joining 'Creative Minds' makes me feel that I am up to date with the latest developments and challenges related to science and environment.
- Statement 11: The page increased my sense of responsibility towards the environment; I feel it is my responsibility to take action in the local and

international environmental campaigns and petitions.

The mean scores of responses to statements 10 and 11 are equal to 3.43 and 3.08 respectively. This suggests that the respondents felt neutral about the page's contribution to their awareness and responsibility towards current and ongoing environmental and scientific issues.

5. Discussion and Conclusion

The numbers of social network users have been growing tremendously over the past few years. This advance, coupled with the increased capacity of social networks could be utilized in science education through the use of social networks as virtual informal science learning settings. The role of social networks might be significant in popularizing science and increasing students' motivation about science [4]. The purpose of this study is to evaluate the impact and the role of social networks in increasing interest in science and science literacy specifically in the fields of science, technology, society and environment (STSE). At the most basic level, this study aims to investigate the extent to which the page 'Creative Minds' is increasing interest in science and promoting awareness about current and ongoing issues in science among the targeted audience of the page. The research was accomplished through creating an online questionnaire that evaluates the audience's perspectives on the impact of the page on their interest in science and science literacy.

The page represents an attempt to employ social networks in education by employing it as informal learning tool, however, this study aimed at evaluating two aspects of the use of social networks for educational purposes. Overall, positive responses were received and a few challenges appeared through analyzing the results which might have hindered the accomplishment of some of the page's desired goals.

Two themes were highlighted in the questionnaire, the first theme included statements that reflect the impact of the page 'Creative Minds' on increasing interest in science among the audience. Responses indicate that the page offers new and interesting topics and show that responding audience are satisfied about the way new topics are presented which employs pictures, videos and interactive applications.

The responses also suggest that most of the

audience may prefer to share the topics and get involved in science-related discussions outside the Facebook context; this might be the case due to the diversity of the audience, with different levels of scientific knowledge and understanding. This might also explain why specialized social networks, which are directed at people with expertise and knowledge on the specialized topics, have higher levels of interaction.

Users' engagement in science culture can be reflected on Facebook or outside the Facebook context through sharing and discussing the page's posts with their communities. One of the advantages of Facebook pages is that they provide four levels of user engagement for each post (including Reach, Engaged Users, Talking about This, and Virality) which might be a useful tool for following users' engagement with the topics.

The second theme aimed to evaluate the role of the page 'Creative Minds' in promoting awareness about current and ongoing issues in science. Responses indicate that most of the respondents felt neutral about their identification with the scientific community as an impact of joining the page, this suggest that additional efforts must be given to the encouragement of the audience to participate in current and ongoing international science events. On the other hand, more research should be conducted in order to find the tools that make more effective use of social networks in increasing the audience identification with the scientific community. This was also emphasized by the respondents' perception about the impact of the page in connecting science to the society and environment, and their awareness about and responsibility towards current and ongoing scientific and environmental issues. Those results highlight the importance of evaluating the page by the audience continually to investigate the long-term impact of the page on their awareness about current and ongoing issues in science.

The findings imply that social networks could be an effective research tool as there is a direct interaction with wide range of communities. A continuous collaboration between educators and social networks developers can lead to developing new tools that will make a better use of social networks in this field. Facebook fan pages could be one of the effective tools, not only for their role in education, but also in providing advanced insights which can reflect the level of interest in each topic, and help in analyzing the stages of engagement of the

audience.

One of the main challenges faced in running the page was the recent changes in Facebook's policy for fan pages, which limit the posts from the user's newsfeed unless they add comments, share or like the posts. An additional challenge which is always faced is related to people's preconceived ideas and cultural concerns which conflict with some scientific facts. The different levels of scientific knowledge and reading culture among the audience were also witnessed, this is due to the fact that the page targets a wide range of audience; this emphasizes the importance of simplifying posts in a way that attracts and maintains everyone's interest, in addition to emphasizing the visual aspect of the posts rather than the solely text-based posts. An additional challenge might be the audience's perception of the connectivity of the science-related / environmental global events to their daily lives. The language of the broadcasts for such events being in English may hinder the possibility of following-up with the event by the non-English speakers, thus some of the audience may find it challenging to maintain interest in participating in such events.

Despite the contribution of this study, there are still limitations concerning the outcome of the study. Conducting this study after a longer period and page history could result in more valuable findings where respondents can have the opportunity to engage more with the page's content and updates. Moreover, only two aspects have been chosen in this study, where other aspects need further evaluations.

References

- [1] McCarthy J. Blended learning environments: Using social networking sites to enhance the first year experience. *Australasian Journal of Educational Technology* 2010, 26(6): 729-740.
- [2] Heinrichs JH, Lim, JS, et al. Influence of social networking site and user access method on social media evaluation. *Journal of Consumer Behaviour* 2011; 10(6): 347-355.
- [3] Hurd, PD. Scientific literacy: New minds for a changing world. *Science Education* 1998; 82(3): 407-416.
- [4] Battrawi B. and R. Muhtaseb. The Use of Social Networks as a Tool to Increase Interest in Science and Science Literacy: A Case Study of 'Creative Minds' Facebook Page. *Proceedings of The Second Edition of the International Conference New Perspectives in Science Education*; 2013, Florence, Italy
- [5] Kateman, B. Social Media and the Love of Science; 2012 from <http://blogs.ei.columbia.edu/2012/02/29/social-media-and-the-love-of-science/>
- [6] Liu, X. Beyond Scientific Literacy: Science and the Public. *International Journal of Environmental and Science Education* 2009; 4 (3); 301 – 311.
- [7] Battrawi, B. Raising Palestinian Women's Interest in Science through Informal Learning Activities: A Case Study of "The Transit of Venus." *Proceedings of the 9th International Conference on Hands-on Science*. Costa MF, Dorrio BV, Erdogan M, Erentay N (Eds.); 2012, 17-21 October; Akdeniz University, Antalya, Turkey. 2012. 93 - 101.
- [8] Selwyn N. Faceworking: exploring students' education-related use of Facebook. *Learning, Media and Technology* 2009; 34 (2), 157 – 174.
- [9] Mason R. Learning technologies for adult continuing education. *Studies in Continuing Education* 2006; 28 (2). 121–33.
- [10] azen R. & Trefil, J. *Science Matters: Achieving Scientific Literacy*. New York: Anchor Books; 2009.
- [11] Laetsch, W.M. A basis for better public understanding of science. In *GIBA Foundational Conference (Ed.)*, *Communicating science to the public* 1987; p. 1-18. New York: John Wiley & Sons.
- [12] Boyd DM, Ellison NB. Social network sites: Definition, history, and scholarship. *Journal of Computer-Mediated Communication* 2008; 13: 210–230.
- [13] A.M. Qattan Foundation. *The Walid and Helen Kattan Science Education Project Document* 2011; Ramallah, Palestine: A.M. Qattan Foundation.
- [14] Wahbeh N. Teaching and Learning Science in Palestine: Dealing with the New Palestinian Curriculum. *Mediterranean Journal of Educational Studies* 2003; 8 (1): 135 – 159.
- [15] Hargadon, S. Educational networking: The important role Web 2.0 will play in education; 2009, <http://audio.edtechlive.com/lc/EducationalS>

ocialNetworkingWhitepaper.pdf [Retrieved
12-Dec-2010]



INVESTIGATION OF SEQUENCES USING DIGITAL COGNITIVE TECHNOLOGIES

Stanislav Lukáč, Jozef Sekerák

*PF UPJŠ in Košice/Institute of mathematics,
Košice, Slovakia*

stanislav.lukac@upjs.sk,

jozef.sekerak@upjs.sk

Abstract. *Characteristic feature of digital cognitive technologies is the possibility of their use for support and facilitation of cognitive practices which can be applied in various teaching and learning activities. Digital cognitive technologies useful in mathematics teaching provide various tools to solve different types of mathematical problems. More types of digital cognitive technologies can be appropriately used for investigation of sequences and searching of formulas for the calculation of sequence members. In this contribution, we focused on the use of different possibilities of a spreadsheet for creation of tables in which are incorporated recurrence relations between data. Designing of worksheets is based on providing of feedback for monitoring of continuous students' results. To make students think about the process of problem solving, the worksheet is divided into more sheets which contain the particular steps of solution of the problem. Showing next part of problem solving is conditional on right solution of partial tasks in the previous sheets. Dynamic geometrical system Geogebra offers even more advanced tools to the investigation of sequences. The system Geogebra is complex software which integrates tools for geometry, algebra, symbolic manipulations and also creation of tables. Possibilities of the use of the system Geogebra for manipulation with different representations of data that helps to create an environment for active investigation of relations between sequence members and for development of students' cognitive abilities are demonstrated in the contribution.*

Presented tools of spreadsheet and the system Geogebra are used for calculation and graphical representation of different types of sequences.

Investigation of sequence features is the first step to derive formulas for the calculation of sequence members. The main attention is devoted to derive analytical formulas of the n -th member for determination of the sequences. We tried to include problems which require investigation of the relationship between variables derived from real situations with which students have experiences from everyday life.

Keywords. Sequences, spreadsheet, Geogebra, representations of data, mathematics teaching, problem solving

1. Introduction

Meaningful and effective use of digital technologies in the teaching process can contribute to stimulate active learning, create positive students' attitudes towards mathematics and to develop cognitive skills of students. Digital technologies which can significantly contribute to investigate patterns and relationships and to facilitate cognitive activities in the organization of various learning activities are usually named as digital cognitive technologies [4]. Computer assisted instruction should be based not only on the integration of digital technologies into the traditional methods of teaching but it should respect the innovative trends in education. Modern teaching methods in mathematics place main emphasis on active approach to acquire new knowledge and skills. Creating a stimulating learning environment and thoughtful organization of learning activities are important conditions for the application of modern approaches to learning. Digital technologies offer a variety of tools and therefore can be the dominant component of various forms of learning environments. Teaching systems represent one type of learning environment in which the authors incorporate strategies to support the learning process. Classical teaching programs can be included in this group of systems. Development and assessment of potential possibilities of use of these systems require considering the basic types of interactions between all actors of the educational process. Base interactions in the development and use of digital teaching systems are illustrated in the following scheme.

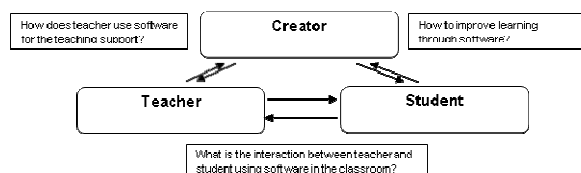

The system Planet of education can be included into this type of digital teaching systems. Its use in the teaching requires from the teacher to select educational content and activities and to plan way of their implementation in concrete stages of the teaching process.

Other types of software systems can also be used to promote active learning in which learning strategies are not covered. The use of open educational environment in teaching requires teachers' skills of basic work and recommended practices in the use commands of the software and understanding the relationship between the ways of use of the software and the skills and knowledge developed in the teaching subject.

Digital technologies bring various potential options of the improvement of the teaching process to the education. The most proclaimed are:

- visualization – to increase the clarity of teaching static and dynamic graphical representation of the data can be used that allows to create the adequate visual imagination in students' minds,
- interactivity and dynamics – in educational applications can be implemented an immediate reaction to external stimuli in the form of providing feedback or dynamic changes of objects which are depended on the altered parameters. Aspects related to the providing of interactivity and feedback are further elaborated in [2],
- use of various models and simulations of the real processes – digital technologies enable to create various types of models for the representation of the objects and mathematical structures and also to execute simulations of the real processes.

In our research we focused on exploration the possibilities of using and application of three basic types of mathematical systems:

- dynamic geometrical systems (Geogebra, Cabri II Plus, Cabri 3D),
- CAS-type programs (Wolframalpha, Derive),
- spreadsheets (MS Excel, Google documents).

In this article we concentrated on the elaboration of proposals to use different representations of sequences for investigation of their basic properties using digital cognitive technologies.

We created tables to calculate the sequences members based on recurrence relations between their members. Spreadsheet environment is suitable for the implementation of recurrence relations to the tables which allows to define the links between individual cells of the table through formulas. Mathematical tools in the form of implemented functions and commands enable students to execute numerical computations, analysis of data and dependencies in the tables. Different types of graphs can be also used to interpret and clarify the relationships between data.

Dynamic geometric system Geogebra offers even more advanced tools for exploring sequences. Geogebra is one of open learning environments for support of mathematics teaching and learning. This system provides tools derived from classical drawing devices such as a ruler and compass which allow to construct quickly and easily various geometric figures in dynamic geometry environment. In addition dynamic implemented in this system allows to manipulate with the free geometric objects and to observe changes of dependent objects. System Geogebra represents a comprehensive tool that integrates modules for algebraic-analytical computations and geometric constructions. Geometric objects can be linked to data in the inbuild table in which can be performed basic operations spreadsheet. The latest version of Geogebra already contains the CAS module which enables to users execute symbolic calculations.

2. The calculations of sequence members using spreadsheet

Spreadsheet is one of the representative of digital cognitive technologies which is available for support of the mathematics learning. Its great advantage is offering advanced environment with implementing tools to create and use different types of models. Modelling is an important mathematical competence which is applied in the investigation of mathematical patterns and relationships and in solving mathematical problems.

We chose a mathematical problem requiring proof of a mathematical formula to illustrate the use of the spreadsheet in investigation of sequences.

Problem 1: A sequence of numbers is defined in the set of natural numbers recursively:

$$(1) \quad a_n = 2(n + a_{n-1}), \quad a_1 = 2.$$

Show that an inequality $a_n \leq 2^{n+2}$ holds for the first 20 members of this sequence. Propose a method of proof of this inequality for all natural numbers.

We prepared an interactive worksheet for students. Those students had to think about the process of solving of mathematical task and about the expression of mathematical relations through formulas, worksheet is divided into several sheets which contain the steps of task solution. Figure 1 shows the part of the first sheet containing a partial task for students which requires to write a formula expressing the given recurrence relation (1).

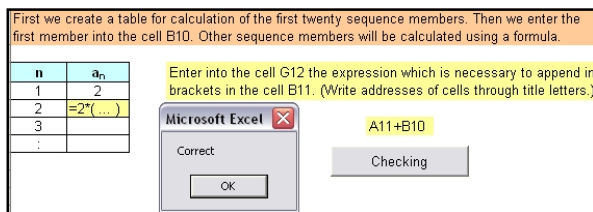

Figure 1.

Correct completing of formula in the cell with yellow background and its confirmation activates next sheet with a table containing the calculation of the first 20 members of the given sequence. The next part of solving of problem consists of addition the third column for calculating the difference $2^{n+2} - a_n$ in the table.

The final table is located on the third sheet. This sheet contains also another partial task for students. Students should observe in the table that calculated differences determine increasing arithmetic sequence. Students are asked to determine the formula for calculating the n -th sequence member. Assignment of partial task with the correct answer is shown in Figure 2.

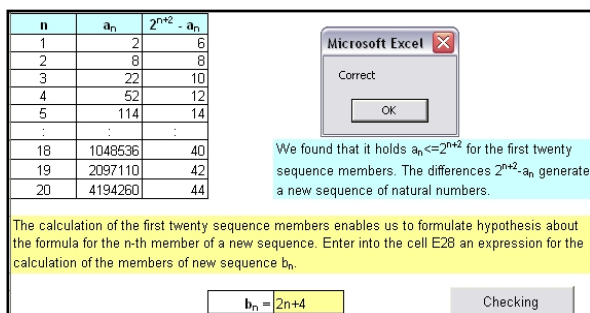

Figure 2.

The last sheet contains a summary of problem solution and proposal of proof method of given proposition. For the first 20 sequence members we found that difference $2^{n+2} - a_n$ increases and determines an arithmetic sequence. N -th member of this arithmetic sequence is determined by expression $2n + 4$. Finally it is necessary using mathematical induction to prove that the difference $2^{n+2} - a_n$ determines the sequence of $\{2n + 4\}_{n=1}^{\infty}$ for all natural numbers.

If the student has difficulties with finding of formula for calculating the n -th member of the resulting arithmetic sequence they can use a graphical representation of the calculated sequence members. The fact that the corresponding points lie on a straight line should lead the students to arithmetic sequence which expresses the linear relationship between variables.

3. Identification of relationships determined with sequence members

Tasks in which several first sequence members are specified and a student is asked to append several following sequence members are often found among the typical tasks for determining sequences. Tasks of a similar type are usually included in various IQ tests. The student has to discover the connection between given sequence members and use it for appending the next numbers.

Students had to use properties discovered arithmetic sequence by solving of the problem 1. This simple connection between sequence members in problem 1 can be easy expressed mathematically. The next problem enables students to apply various approaches to appending the members to given sequence of numbers and investigation of relations between given numbers leads students to the complicated functional dependencies.

Problem 2: Given three numbers 1, 2, 4 which represent the first three members of sequence. Characterize a relationship between those numbers and use it to append several following members. Based on the given three numbers students could easily notice that all three numbers represent consecutive squares of number 2. Then numbers $2^3, 2^4$, etc. should follow. Discovered sequence represents geometric sequence with quotient 2. Analytical

expression of n-th member can be written in form: (2) $a_n = 2^{n-1}$, $n \in N$.

Exponential dependence can be used for characterizing a geometric sequence.

If we focus on differences between consecutive numbers are differences 1 and 2. Then differences 3, 4, etc. could be follow. We receive the sequence 1, 2, 4, 7, 11, How to find the expression of n-th member of the sequence? Insight into solving the problem can lead to identification of function dependence determined of sequence members. In this case it cannot be a linear relationship because the differences between consecutive members are not constant. The differences between consecutive members increase uniform in described sequence. The differences (1, 2, 4, 8, etc.) between consecutive members of sequence (2) are increasing but much more rapidly. This fact leads to exponential dependence which cannot be applied to investigated sequence.

Quadratic dependence is another type of students known dependence. We use the table of function values at the points 1, 2, 3, 4 and the graph of quadratic function $f : y = ax^2$, $a \in R^+$ to investigate differences of function values assigned to consecutive positive integer. The graph and the table with differences in columns: $p1 (f(2)-f(1))$, $p2 (f(3)-f(2))$, and $p3 (f(4)-f(3))$ are shown in figure 3.

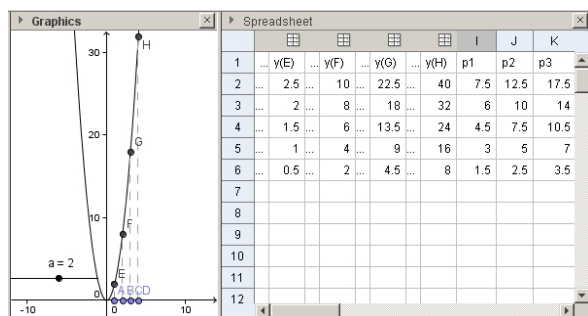

Figure 3.

We construct graph of quadratic function f for selected value of coefficient a and we mark selected points. Roller displayed in left window in figure 3 is used for changing of coefficient a . Attribute Record to Spreadsheet is set for each selected point on the graph of function f . Changings of coefficient a induce writing of coordinates of points into the table. We calculate differences of y-coordinates of adjacent points ($p1, p2, p3$) through simple formulas. Values calculated in the table illustrate the fact that differences increase uniform. Dynamic

construction can be generalized for quadratic function $g : y = ax^2 + bx + c$, $a, b, c \in R, a \neq 0$ using another variables. Discovered connection between function values of quadratic dependence can be justified by means differential calculus.

Base on the discovered connection between sequence members we derive analytical expression for n-th member of investigated sequence in form:

$$(3) \quad a_n = an^2 + bn + c, \quad n \in N.$$

We obtain a system of three linear equations with three unknowns a, b, c substituting the three sequence members in formula (3). CAS module can be used for this routine calculation. We apply relevant command to compiled equations and we receive the result: $a = 1/2, b = -1/2, c = 1$. N-th member of sequence is determined by the formula:

$$(4) \quad a_n = \frac{1}{2}n^2 - \frac{1}{2}n + 1, \quad n \in N.$$

4. Different ways of the sequence determination

In many cases insight to connection between sequence members allow simply to complete recurrence relationship. We chose problem from real life of children which is related to children's play with cubes to illustrate the different ways of the determination of the sequence.

Problem 3: Children built stairs using cubes (see figure 4). Determine how many cubes will be used for building of stairs in the n-th step.

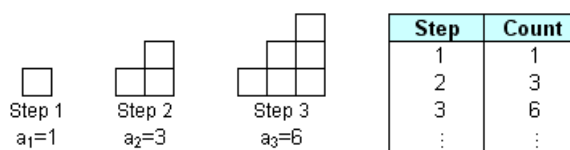

Figure 4.

Short investigation leads to observation that the transition from step k to step $k+1$ adds $k+1$ cubes. Count of cubes for building of stairs in step n can be express recursively:

$$(5) \quad a_n = a_{n-1} + n, \quad a_1 = 1, \quad n \in N.$$

The recurrence relation shows that number of added cubes increase uniform and therefore analytical relationship for calculation of the n-th sequence member will represent quadratic dependence. In this case we will not solve a system of linear equations but we will use

another way.

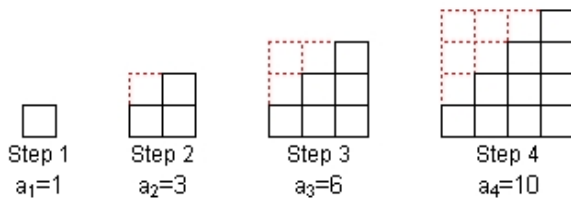

Figure 5.

Completion of the picture of stairs to square (see figure 5) shows that we receive in the n -th step the square containing n^2 squares which represent cubes. We added $n-1$ squares in horizontally and vertically direction around the perimeter of the square. The total count of added squares is equal to count of squares in previous step. Using described consideration can be express recursively n -th member:

$$(6) \quad a_n = n^2 - a_{n-1}, \quad a_1 = 1, \quad n \in \mathbb{N}.$$

We express a_{n-1} from relationships (5) and (6). We obtain equation:

$$(7) \quad a_n - n = n^2 - a_n.$$

Adjustment of the equation (7) leads to expression of n -th sequence member:

$$(8) \quad a_n = \frac{n^2 + n}{2}.$$

Another approach usable in high school can consist in determination of sum of the first n natural numbers.

We use the system Geogebra for graphic representation of explored sequence. First we complete the next two steps into a table. We construct five points represented the first five sequence members in window Graphics. Then we build conic using command Conic through Five Points. Result is shown in figure 6. Analytical expression of constructed conic is written in the Algebra window. It accords with derived relationship (8).

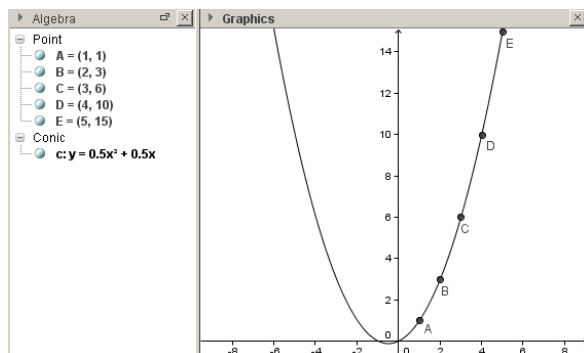

Figure 6.

We extend the problem 3 to building of pyramids. It leads to investigation of another kind of dependence.

Problem 4: Children built pyramids using cubes (see figure 7). Determine how many cubes will be used for building of pyramid in the n -th step.

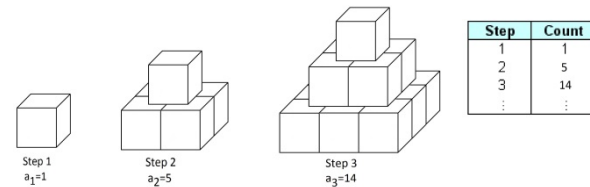

Figure 7.

First we derive recurrence relationship between sequence members. The transition from step k to step $k+1$ adds by building of pyramids $(k+1)^2$ cubes. Relationship for the calculation of n -th sequence member can be expressed in form:

$$(9) \quad a_n = a_{n-1} + n^2, \quad a_1 = 1, \quad n \in \mathbb{N}.$$

Differences between members of this sequence increase more rapidly than by building of stairs in the problem 3. Recurrence relation shows that increasing of differences between consecutive members can be characterized through quadratic dependence. The speed of increasing of cubic function can be characterized on the basis of knowledge of differential calculus through quadratic dependence. We try express the formula for cubic function using the first four sequence members. CAS module in the system Geogebra will be used to solve a system of linear equations too.

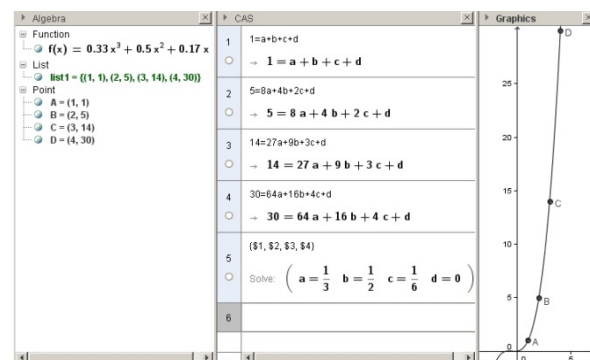

Figure 8.

First we create the list of points representing sequence members using entering data in the cells of the table or writing command List into input bar together with coordinates of points. Then we write and solve related system of four linear equations. The result is displayed in figure

8. Finally we can apply command Polynomial with defined list of points. Graph of cubic function appears in the window Graphics. The formula of the cubic function is written into the Algebra window. All three windows together with described data and graph are displayed in figure 8.

5. Conclusions

The organization and guiding of learning activities focused on experimentation with various representations of data and investigation of relations between data is important for acquisition of mathematical concepts and knowledge. Understanding of mathematical knowledge is basis for development of students' competences to apply mathematical knowledge and skills in various situations and for problem solving.

Dynamic geometrical systems provides advanced tools for implementation of stimulating learning environment which allows work with various representations of data for use of different types of models. Our experience shows that the system Geogebra considering extensive options and easy availability belongs among the most utilized software systems in mathematics teaching. Although we have described only some of the possibilities of its use in the investigation of sequences in this article, Geogebra is versatile system usable in the mathematics education at primary schools and secondary schools and also universities.

It is necessary that teachers appropriately and meaningfully use the system Geogebra in mathematics teaching, to create not only guides explaining the environment and the commands of the program but also to provide teachers proposals and examples of its use in teaching of concrete topics. Then it depends on the skills and mastery of teacher as he can use offered digital tools to create a stimulating learning environment in which students can actively acquire and develop knowledge and skills and also discover new knowledge.

6. Acknowledgements

The article was created with the support of a grant VEGA 1/1331/12. We would like to thank all members of project teams for secondary schools who have contributed to the presented work, the result of the Slovak national projects Modernization of education at primary and secondary schools (ITMS project codes:

26110130083, 26140130013, 26110130084, 26140130014) supported by the European Social Fund.

7. References

- [1] Hanč J, Lukáč S, Sekerák J, Šveda D: Geogebra - a complex digital tool for highly effective math and science teaching. In: ICETA 2011: 9th IEEE International Conference on Emerging eLearning Technologies and Applications, Stará Lesná, 2011. ISBN 9781457700507.
- [2] Hančová M, Lukáč S, Sekerák J and I. Semanisinova.
- [3] Hohenwarter, M., Preiner, J.: Dynamic Mathematics with GeoGebra, The Journal of Online Mathematics and Its Applications, 2007. ISSN 1935-6439.
- [4] Vaniček, J.: Počítačové kognitivní technologie ve výuce geometrie, Charles University in Prague, 2009. ISBN 9788072903948.



VIDEO RECORDINGS OF SCHOOL PHYSICAL EXPERIMENT

František Látal, Zdeněk Pucholt

*Department of Experimental Physics, Faculty of
Science, Palacký University, Olomouc, Czech
Republic*

frantisek.latal@upol.cz, zdenekpucholt@email.cz

Abstract. *The computers and the Internet have become powerful tools for teaching and learning physics at all levels of science education. This paper presents the preparation and the implementation of video recordings of school physical experiments which are available via internet, especially for the teachers of basic and secondary schools. This paper includes examples of videos for teaching physics and analysis of physical phenomena using free video analysis and modelling tool Tracker. The second section describes experiments with video clips. Finished projects and demos can be found on the website <http://pokusy.upol.cz>.*

Keywords. Experiment, ICT, physics, video analysis, video clips

1. Introduction

Information and Communication Technologies (ICT) provide a wide range of possibilities in teaching physics. A possible way of motivating students in teaching and learning physics is to use ICT in physics and science lessons. It is necessary to combine traditional and simple experiments with multimedia.

We live in a time of development of information technologies, which will certainly be reflected in the educational process. The school environment must be changed – the leading role of the teacher in physics education must be changed to the role of a discussion manager and an organiser of student's activities. The school education has to come closer to student's practical life and this can be done only by improving the ways of student's own activities. Only then the student will be prepared for life in the changing society. From this point of view, the experiment has a basic didactic and methodological function and students have to recognize the importance of experiments in science [2].

Nowadays, several types of experiments are used in physics teaching and learning: classical experiments, hands on simple experiments, virtual and remote control experiments (enables users control of real experiment from a remote location using internet and an ordinary web browser [1]) or video recording of an experiment.

The following text will discuss video recording of an experiment that was created at the Department of Experimental Physics in Olomouc, Czech Republic. All materials contained in the article are available on-line to teachers, students and the public on the website www.pokusy.upol.cz [3] (see Figure 1) for free.

2. Video recording of an experiment

Real, classic, face to face experiments are a key factor of experimentation in primary and secondary schools. Working in the traditional school laboratories provides a direct contact with real measure equipment and offers an immediate feedback of the teacher or the classmates. Students gain practical skills during the preparation and measurement of individual experiments in these laboratories. However, there are situations when it is appropriate to replace or supplement the classic experiment to experiment with video recording. Without a doubt, it is necessary to replace a real experiment in these cases: dangerous experiments, long-term

experiments, very fast experiments, microscopic and macroscopic experiments and financially demanding experiments [6].

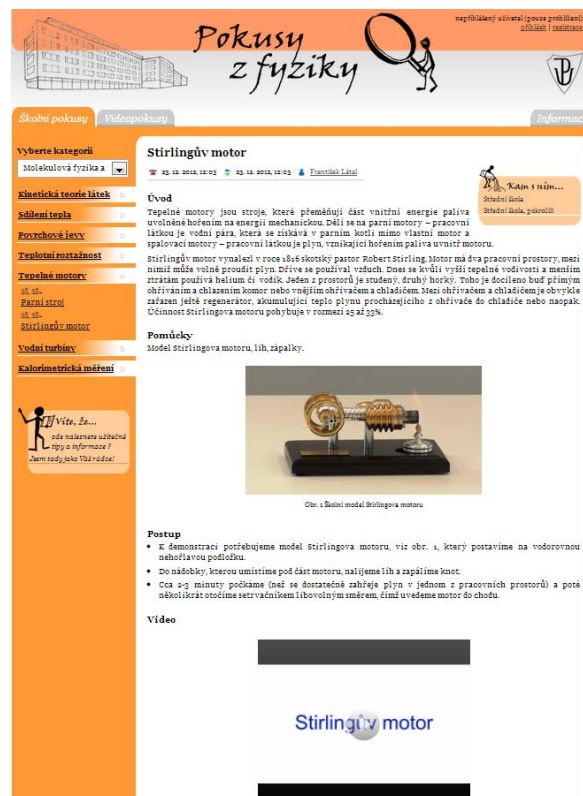

Figure 1. Website www.pokusy.upol.cz

The web page www.pokusy.upol.cz is divided into two parts. The first section is based on the master thesis of Zdeněk Pucholt [4] and contains 10 physical experiments with video analysis. Nowadays, there are many video analysis software packages, such as AviStep, Logger Pro, Physics ToolKit, Tracker and VianaNET. At our department we decided to use the program Tracker for video analysis.

The second section includes school physical experiments suitable for teaching at the secondary school. There are about 50 experiments on the website and approximately 30 of them contain a short video clip with experiment.

3. Software Tracker

Program Tracker is a free video analysis and modelling tool built on the Open Source Physics (OSP) Java framework. It is designed to be used in physics education [5]. Installers for Tracker version 4.80 (available for Windows, Linux and Mac OS X operating system) are free downloadable from <http://www.cabrillo.edu/~dbrown/tracker/>. To start the program, it is necessary to have JAVA

SE (Standard Edition) and QuickTime Player installed. The benefits of this program include:

- availability – free download;
- simple installation using the installation wizard;
- several languages;
- multi-platform application for Windows and Linux OS;
- broad support for input and output formats of videos and images;
- continuous development, adding new features and improvements.

There are some disadvantages, but on the other hand they are negligible in comparison with the advantages:

- the necessary cooperation with other programs (QuickTime Player);
- limited opportunities for representation of vectors of Forces (the velocity vector has the same colour with the vector acceleration);
- unsuitable graph export (impossibility of changing the size of the exported chart).

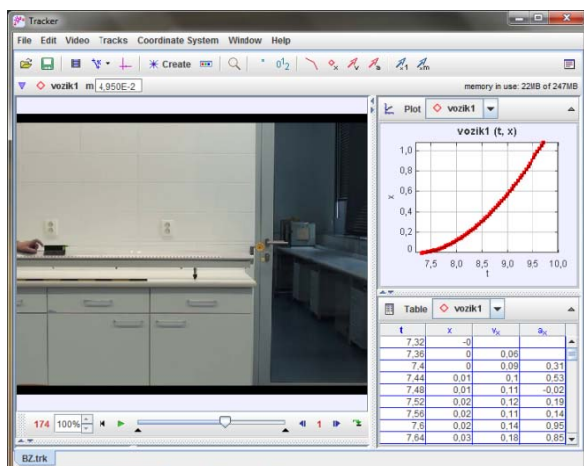

Figure 2. The main view of software Tracker

The main view of software Tracker displays the following components (see Figure 2):

- a main video view that displays video images;
- a menu bar that offers access to most program commands and settings;
- A player that controls the video playback and video clip settings;
- Additional views in attached view panes.

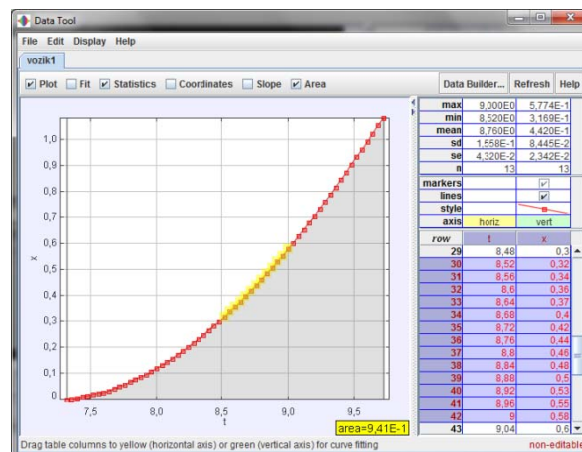

Figure 3. Picture displays a Data Tool with statistics, curve-fitting and other analysis capabilities

For video analysis in Tracker program item Data Tool is used (see Figure 3).

Program Tracker includes a broad digital library. The digital library enables users to browse and search collections of library resources such as videos and Tracker experiments. Collections may be located on a local drive or remote server. Teachers can use these videos from archive and analyse them alone (e. g. [7]). We decided to make our own video clips from classical physics area. Four clips are from kinematics, two from dynamics and four videos are from the mechanical vibrations and waves area. Didactic analysis and video analysis of these experiments are described in detail on the website www.pokusy.upol.cz.

4. Video clips with experiment

The second part of webpage of authors incorporates traditional and non-traditional school experiments. The aim of this website is to provide user-friendly and didactically comprehensive material for teachers that can be used directly in the classroom with using a computer and overhead projector, or it can be an inspiration for teachers to prepare real demonstration with real equipment.

Nowadays is on the website approximately 50 school experiments mainly from the areas of mechanics (examples of experiments: Atwood machine, fluid flow (see Figure 4), fluid pressure, pressure in vacuum chamber) and molecular physics (examples of experiments: surface phenomenon, thermal expansion, heat engines).



Figure 4. Experiment fluid flow



Figure 5. Video clip shaving foam in the vacuum pump

Each experiment contains brief theoretical introduction, list of tools, classification according to the curriculum, picture with

experiment, brief procedure how to prepare and conduct experiment, explanation of the phenomena and additional notes or links to other websites with similar experiments. Users registered on the website can discuss and comment experiments. About 30 experiments contain a short video clip, no longer than 2 minutes (see Figure 5). These experiments can be used in different stages of teaching (motivation, fixation, application or final revision). It is appropriate to combine the application for video recordings with real experiments [6].

5. Conclusions

Conducting experiments is a necessary part of teaching physics at all levels of science education and helps students to understand the basic natural phenomena and the principles related to the subject. There is a whole number of options that were not previously available. Video experiments are one of the possibilities. By combining physical skills and knowledge of computer it is possible to introduce new teaching element which brings a lot of benefits. As the information and communication technologies evolve, the concept of performing experiments in science education changes as well. The world around us is changing and we must change our approach to physical experimentation at school.

6. Acknowledgements

The support of the ESF project No. CZ.1.07/2.2.00/28.0168 is gratefully acknowledged. The authors gratefully acknowledge the support by the ESF project No. CZ.1.07/2.2.00/28.0182. The projects are co-financed by the European Social Fund and the state budget of the Czech Republic.

This work has been supported by the internal IGA grant of Palacky University (PrF_2013_009).

7. References

- [1] Látal F. Remote teaching laboratories in physics lessons – Attitudes of students and teachers to the remotely controlled experiments. *Problems of Education in the 21st Century*. Vol. 37; 2011, p. 83-89.
- [2] Látal F, Holubová R. Remote experiments – New approaches to physical experimentation. *Proceedings of the Union*

- of Scientists – Ruse. Book 5. Mathematics, Informatics and Physics. Vol. 7; 2010, p. 73-78.
- [3] Látal F, Pucholt Z. Pokusy z fyziky. <http://pokusy.upol.cz/> [visited 05/15/2013].
- [4] Pucholt Z. Videopokusy z fyziky. Master thesis. Olomouc, Czech Republic: Palacky University; 2012.
- [5] Tracker. <http://www.cabrillo.edu/~dbrown/tracker/> [visited 05/15/2013].
- [6] Trna J, Novak P. The educational roles of video programs with experiments. In: Multimedia in Physics Teaching and Learning. Udine, Italy: University of Udine; 2009.
- [7] Wee L. et al. Using Tracker as a pedagogical tool for understanding projectile motion. Physics Education. Vol. 47 (4); 2012, p. 448-453.



AFFORDABLE TECHNOLOGY FOR EDUCATION IN PALESTINE

Hamzeh S. Kirresh

Student

Birzeit University

Ramallah -Palestine

Hamzeh_1990@hotmail.com

Abstract. *Palestine is a 3rd world country where education will help develop self-sustainability. Embedding technology into school education is encouraged. The aim of this workshop is to show how the Raspberry Pi can be used to introduce or enhance technology in education. The workshop will include; 1) a presentation on the difficulties of the provision of technologies in educational systems 2) hands on demonstration on how the Raspberry Pi can be used with different sensors 3) an introduction on the simple coding needed to run the devices that was developed to the purpose of using the Raspberry Pi in hands on experiments.*

Keywords. e-learning, Hands-on science using Raspberry Pi, ICT and the Raspberry PI, Raspberry Pi

1. Introduction

Education is being challenged by the rapid development in technology. Schools cannot cope with this rapid change. Upgrading infrastructure and developing new professional development programmes are not easy low cost steps. Taking fast decisions without referring to research is another problem. Research usually takes several years and lags behind the fast pace of technology [7]. Therefore questions stand out about which technologies should educators be informed of. As though a technology might not be directly manufactured for education, but can be used for the purpose. Mobile technology is a clear example of technology used widely in education but were not synthesised for the purpose. They represent instant mobile accessibility to information as a very important commodity for education.

As ICT in education is growing fast, developing countries have no chance of keeping up. The problem of computer, technology hardware and software availability is a problem. Effective technologies are needed to enhance student understanding and learning specifically of scientific material. Science and technology education have a long standing history highlighted by the Science, Technology and Society; STS movement in the 1970s. Science educators suggested that science curricula should be organized around societal and technological issues [8]. There is also a need to build up students experience in modern technologies and in computer science hardware, software and applications. It is necessary to give ICT in education in developing countries a boost forwards to run in line with the world's progressive direction.

Some of the current uses for technology in education include computers, online tutoring and e-books. New forms of learning are emerging based on computer and mobile technology. Gps and simulations are also used. Developing countries do not have wide access to such technology, because of cost or lack of necessary infrastructure. Raspberry Pi might stand a chance in solving these problems.

2. E-Learning

Teaching tools have reshaped education by providing information, resources, communication and collaboration at individual and institutional levels [8]. E-Learning is

considered an important facility for long distance and open education. In developing countries such as Palestine an initiative is being made to introduce e-learning into the educational system, since the educational system is facing a steady increase in the number of students per teacher, reaching a value of 23.8 student / teacher in 2011[14]. There are not enough resources including financial, materials and infrastructure [1]. As ICT is having a large impact on the educational system worldwide it still did not reach developing countries, the countries that need it the most since they have a growing demand for education but a lack of educators, computers and skills [2]. In order for e-learning to be efficient the provided material needs to be introduced in a classroom and still remain challenging. It should include multimedia resources that enhance better understanding of abstract texts. It should be always kept up-to-date, and under review by officials[3].

Within a positive view of technology use in education, it should be considered that education has its demands. Technology should be developmentally appropriate for students. The accessories and additional tools should facilitate teachers' full implementation. And they as technologies should be integrated in the curriculum [10]. Purchasing hardware is a far more important decision than purchasing software with a higher risk value related to efficiency versus cost.

Even though e-learning is not always online, it is still considered a challenge for Palestinians because only 50.9% of the entire population households have a computer, and 30.4% of the households have an internet connection [4].

Acquisition of technology is costly. At institutional level, Wierschem and Ginther [9] asserted some issues related to acquisition and replacement of technology hardware. Most important of which is the high cost of hardware that obliges educational institutes to purchase small numbers of devices each time. This results in different technology being acquired each time. This introduces technical issues of complexity and potential incompatibility between the old and new devices. Another major burden is maintenance cost. Technology requires infrequent physical maintenance, a high level of user support as users in the field of education often need assistance in dealing with software, data, programmes security and installations. Continuous expansion of applications requires upgrading or substitution of hardware. An

additional cost to the use of technology. Steps towards continuous upgrading of hardware are not easy neither in terms of finance nor implementation. Educational systems are always left with equipment that lost its brightness a long time ago.

3. Raspberry Pi and Programming

Raspberry Pi is a low cost mini-PC is seen as a potential re-ignite of interest in basic computer science education among school student. It can be plugged into a television and a USB Keyboard to serve as a fully functional PC that can be carried around by students. It is a more basic PC that lays emphasis on coding and programming skills [13].

So, by using the Raspberry Pi we are increasing the percentage of people having personal computers(50.9%) to about 96.7% [14] as this is the percentage of TV acquisition in Palestine in 20011[14].

ICT education is focused mainly on using technology but not a lot about understanding how computers work. The Raspberry Pi was created to teach computer science as a discipline not as an application. It aims at presenting computer science a general-purpose tool for people to explore and at a low cost [11]. The Raspberry Pi does that by providing a basic computer with the ability to teach programming, electronics, and the open-source Linux operating system[5]. The Pi is also not expensive and is affordable for developing countries such as Palestine.

Pi uses Python as the programming language to interface with its GPIO (global pin input output), that are used to interface to any electronic device. Programming alone is a very effective method to teach basic mathematics and the GPIOs alone are very effective to teach electronics. But combining the two the Raspberry Pi is able to teach mathematics alongside physics, chemistry, and biology.

Python is suitable for introducing a virgin mind to the art of programming. Future programmers are people who chose to use computer. This concept means that at one point people would be forced to use computer without basic knowledge of it. Therefore it is recommended to be taught at about secondary level. There are advantages for teaching Python to all. It will give back to the ordinary people the power to solve simple problems [12]. It is a high level programming language that has an easy syntax and can be

learned in a few days. It has a very large library made by the Python community that allow it to integrate tools from other languages, to carry out any task, and communicate directly with hardware components[6]. Since Python is a simple language to learn and very flexible comparable to other high level languages, school children and teachers can learn it.

The advantage of Raspberry Pi's ability to interface with the world using the GPIO connections which opens a wide range of possibilities. Some of the electronic devices that can be considered in science classroom education include pressure sensors, temperature sensors, and tilt sensors just to count examples. The workshop will include the use of some of these sensors in hands on activities that might reflect the possibilities of using Raspberry Pi in science education. The concept lies in providing substitute for high cost technologies used in the labs.

4. Introduction to hands-on science experiments

"Hands-on approach requires students to become active participants instead of passive learners who listen to lectures or watch films" p.9.[16]. Newton [17] reviewed literature related to the benefits of data logging (collecting and presenting data using computerized systems) and mentioned that data logging in the classroom was found to contribute to the students' understanding and skills of scientific inquiry. Computer draw graphs had a positive impact on the students conception of graphing. Using the tools of scientists is expected to be a much more rewarding and motivating experience. For the children of this century, using such equipment could be like talking the common language of the time. The students would be using the "tools of the time". The prevailing practice built upon manual collection of experimented data may be confusing, redundant and unappealing to the students, particularly that they are immersed in widespread usage of modern technologies in their everyday lives [15].

Data logging requires 1) A computer (Raspberry Pi). 2) Some sensors (Temperature and pressure...etc) that can be connected to the Raspberry PI. 3) An interface (GPIO, ADC and I2C) to connect the sensors to the computer. 4) Some software to store and display the information on the computer (Python language programming).

Research [16]proved a general increase in both student and teachers motivation. The method developed the students scientific method.

4.1. Experiment on pressure and temperature

In this experiment the Raspberry Pi will be used to detect pressure and output the value to a screen. The experiment needs a flask, three-way tube, syringe, pressure sensor, ADC (analog to digital converter), and the Raspberry Pi.

The flask contains air. The flask neck is closed using a rubber stopper to prevent the air from escaping when pressure increases. The three-way tube is connected to the flask as shown in Fig. 1, The syringe is then connected to the second end of the tube and the pressure sensor to the third free end. The pressure sensor is connected to an analog to digital converter (ADC), which is used to convert the analog signals from the sensor to digital values, connected to the I2C pin in the GPIO of the Raspberry Pi. The pressure sensor will start giving readings for the air pressure in the flask. Before starting the experiment disconnect the syringe and read the pressure sensor values. The primary value from the pressure sensor is the normal pressure, reconnect the syringe and observe how the pressure is changed as the syringe is pushed down, starting from a syringe full of air until it is empty.

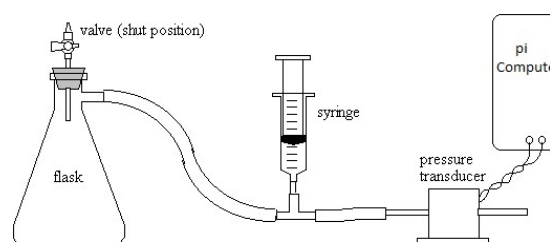

Figure 1. Pressure detection system

To view the effects of heat on pressure, return the system to its original state were the syringe needs to be filled with air. Insert the flask in a water pool containing a thermometer, a temperature sensor can be used instead but for now keep the circuitry simple, heat the water pool and observe how the pressure increases as temperature increases.

4.2. Hands on experiment for determining the terminal velocity on an inclined surface

The goal of this experiment is to teach students about terminal velocity on an incline surface and all the forces that effect the terminal velocity, see Fig.2. To carry out the experiment the incline is set to a previously known degree, and a simple circuit is connected to the Raspberry Pi in order to start a clock timer as shown in Fig.3.

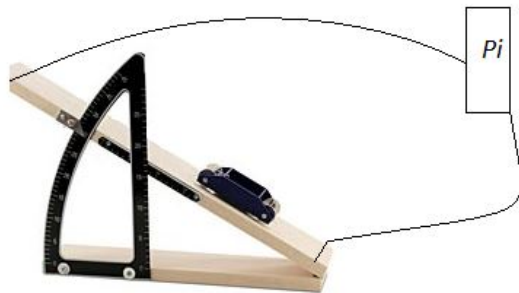

Figure 2. Incline and Velocity

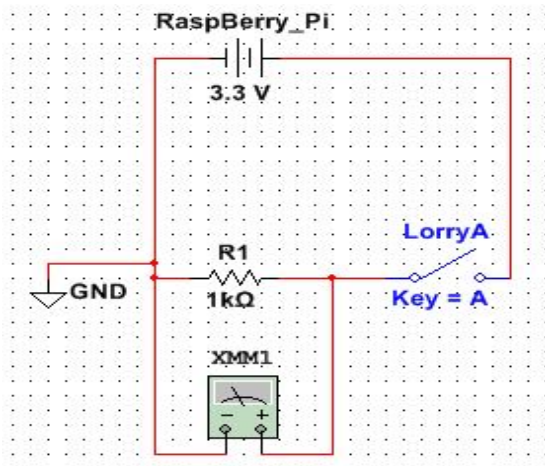

Figure 3. Raspberry pi circuit connection

To measure terminal velocity of the lorry, the student uses the Pi with a simple program, and find's the terminal velocity. The student uses Newton's equation to find the parallel and perpendicular forces, then finds the norm force which is used to find acceleration then terminal velocity. The student compares his result with the Pi's result, which should be almost the same. The experiment teaches the student forces (gravitational and friction), acceleration and terminal velocity.

5. Conclusion

My introduction of Raspberry Pi is not motivated by promotion of a product. Raspberry Pi is a means, not an end, to address an existing lack of IT practical solutions in education. Palestine is considered a 3rd world country, and education is the most important factor in helping any growing country into becoming self-sustained. Though only 3.56% [14] is the weight given to education from the Palestinian national budget, and citizens are able to pay only 4.8% [14] of their income to education. Currently in the world technology is what distinguishes countries, and embedding it into schools education has been encouraged for years now. New trends in education aim at students learning in the most creative ways and at opening new horizons for them for future opportunities. But Information Technology Education is very expensive, and 3rd world countries cannot afford teaching children IT at a large scale. Large financing for equipment, necessary training and development is dependent on grants and projects. We need to level up with cost to have sustainability of learning opportunities. During the technology race the United Kingdom created a computer specially for education, to motivate students back into technology, the Raspberry Pi. It is a low expense computer and controller at the same time, which is very effective since each of them can be bought separately. The Pi runs Linux operating system and uses Python programming language to make it a controller, both of which are easy to learn and are very user friendly. The Pi has pin connections which are used as input/output pins to interface with any sensor, actuator, and communication device. Python programming language is used to control the pin connections for reading values from sensors or controlling actuators such as DC motors. Some sensors that can be connected to the Pi include pressure, temperature, distance, speed, tilt, and many more. And they can all be used to enhance student experience in principles of physics, math, and chemistry using technology. They offer hands on use of technology in experimenting within and outside lab spaces. This offers a chance for students to interact with experiments and technology and environment in one batch. Children can also learn how to program the devices thus opening a wide channel between sciences and technology. In conclusion, introducing the Raspberry Pi implies an education of science and technology.

Its low cost (about 35 USD) makes it competitive not only to computers but also to other learning technologies used in science education. There are vast possibilities of development including increase in memory and in processing capabilities. Development is based on the initial vision of the device to be cheap and available for education [11].

5. References (and Notes)

- [1] Marwan Tarazi: E-learning Prospects in Palestine; 2006
<http://www.thisweekinpalestine.com/details.php?id=1924&ed=132&edid=132>
- [2] Annika Andersson and Åke Grönlund. A conceptual framework for e-learning in developing countries: a critical review of research challenges. *EJISDC* 2009; 38(8): 1-3
- [3] Graham Attwel: E-Learning and Sustainability;
<http://www.guidanceresearch.org/knownet/writing/papers/sustainabilitypaper/attach/>
- [4] Technologist Magazine: More than half of Palestinian youth own computers, have access to internet; 2012
<http://technologist.ps/2012/07/05/more-than-half-of-palestinian-youth-own-computers-have-access-to-internet/?lang=en> [visited 18-May-2013]
- [5] Sean McManus, Mike Cook: *Raspberry Pi for dummies*. New Jersey: John Wiley & Sons, Inc.; 2013
- [6] Ajith Kumar B.P: *Learning Maths & Science using Python and writing them in LATEX*. New Delhi: IUAC; 2010
- [7] Education Week, Technology in Education. *Edweek* 2011. www.edweek.org
- [8] Avraamidou L, Prospects for the use of Mobile Technologies in Science Education. *AACE Journal* 2008; 16(3): 347-365
- [9] Wiershem D, Ginther D, Acquisition and Replacement of Technology Hardware in Higher Education. *Educause Quarterly* 2002; (3): 52-57
- [10] McManis L, Gunnewig S, Finding the Education in Educational Technology with Early learners. *Technology and Young Children* 2010: 14-24
- [11] Edwards C, Raspberry Pi: hobbyist Hardware 'grows up' for Mainstream Applications. *Engineering and Technology Magazine* 2013; 8(3)
- [12] Stajano F, Python in Education: Raising questions of Native Speakers 2013.
<http://www.cl.cam.ac.uk/~fms27/papers/python-native-speakers.html>
- [13] Subramanian K, Low cost mini-PC Raspberry Pi gets heavily booked. *The Hindu* 2012
- [14] Palestinian Central Bureau of Statistics; Palestine's year book of statistics; Ramallah, Palestine; 2011
- [15] Yakubov N, Sobhan S, Iskander M, Kapila V, Kriftcher N, Kadashev A. Integration of real time sensor based experiments in high school science labs: a GK-12 Project. "Proceedings of the 2005 American Society for Engineering Education Annual Conference & Exposition. 2005
- [16] Le Boniec M, Gras-Velázquez A, Joyce A, Impact of data loggers on science teaching and learning. Brusel, Belgium: European Schoolnet; 2012
- [17] Newton L. Data – logging in the science classroom: approaches to innovation; 2013
<http://www.ipn.uni-kiel.de/projekte/esera/book/020-new.pdf>



HANDS-ON EXPERIMENTS AND ELEMENTS OF MODERN SCIENCE IN COURSE OF SCHOOL PHYSICS

Denis Artemenkov, Victoria Belaga,
Ivan Lomachenkov,
Yury Panebrattsev,
Natalia Vorontsova,
Vladislav Zhumaev
yuri@intergraphics.ru

Abstract. *A systematic approach to the study of physics suggests not only formation basic knowledge, but also the formation of the modern scientific world view and way of thinking. We would like to present a set for the study of physics in school (Physics 7-9), which consists of the following components:*

- *Textbook*
- *Electronic Application for Students*
- *Lessons Constructor for Teachers*

- *Laboratory notebook*
- *Exercise notebook*
- *Taskbook*
- *Exam book*
- *Internet support site*

The report aims to show how we have incorporated elements of the knowledge of modern science in the study of the various branches of physics. As an example, we present an introductory section to the physics course "The world around us" and the final section of the course "The Evolution of the Universe" in the textbook and in the electronic application.

We will show examples of the different headings of the Textbook (Physics kaleidoscope, My physical research, Persons in Physics) and examples of the various types of work in the Exercise notebook (Working with text, Watching and thinking, Calculating and comparing, Applying knowledge).

Physical practical to our course of physics along with a set of about 30 standard labs contains about 50 lab works of authorship, including hands-on experiments and laboratory work forming knowledge of the contemporary world view. Different samples of research and hands-on labs we will present.

We have created a site to support our course, which contains materials for students and teachers of modern physics, biology, ecology, and nanotechnology (www.oscsteam.com).

Also, we present an electronic resource Lessons Constructor for Teachers, which allows teachers to create a lesson presentation and include in it media resources about modern science from our database of media resources and interactive models.



WEB-DEVELOPER S TOOLKIT: TEACHING WEB- DEVELOPMENT AT TERNOPIL NATIONAL TECHNICAL UNIVERSITY

**Iryna Berezovska, Anatoly Solovyov,
Oleksandr Matsyuk**
iberezof@gmail.com

Abstract. *The development of web-based products took the form of a multi-stage process to date. It includes:*

- *a clear definition of the objectives and tasks of a project;*
- *designing an application architecture;*
- *development of a product style;*
- *layout;*
- *programming and quality control;*
- *start-up and support, as well as SEO-optimization.*

Like any other product, a web application is created by a team of developers, in which everyone is an expert in a particular field or several fields. Sharing of responsibilities is very effective, but the greatest effect is achieved when each member of the team has the knowledge related to his/her colleagues' areas that. This would facilitate troubleshooting and improve the quality of a final solution due to possible mutual-approval and evaluation.

All these factors are carefully considered when planning a web-development course at the Ternopil National Technical University (Ukraine). Students learn how to define the objectives and formulate tasks while studying different programming tools and languages (C#, PHP, Java). Databases are a foundation of the architecture of any application. That is why the curriculum includes an extensive course of relational databases with a special focus on the SQL language and DBMS MySQL. Web-style is considered in the course titled "Computer processing of text, graphic and multimedia data" through using Adobe Photoshop, Adobe Fireworks and similar software. Layout involves the transformation of graphic layouts created by a designer in html-code. A proper choice of programming platforms, technologies and languages is a critical issue. Development of web-application software, similar to any kind of software, results in various versions of the same products because of permanently changing

initial data. Version Control Systems (VCS) ensure tracking the changes made in a project. The two courses, “Programming technologies and program products development” and “WEB-programming”, deal with the above mentioned matters. After a web-product is tested and uploaded, its support and Search Engine Optimization become a priority task to ensure a reliable operation and high usage. Thus, the web-development curriculum equips our students with a toolkit which they need to develop efficient web-related solutions.



ONLINE SCIENCE CLASSROOM

**Sergey Balalykin, Victoria Belaga,
Alexandr Dirner, Evgenia Golubeva,
Ksenia Klygina, Anna Komarova,
Yury Panebrattsev, Alisa Potapova,
Elena Potrebenikova, Pavel Semchukov,
Alexandr Shoshin, Nikita Sidorov,
Oleg Smirnov, Yulia Stepanova,
Michail Stetsenko, Stanislav Vokal,
Natalia Vorontsova**
belaga@jinr.ru

Abstract. Project “Online Science classroom” is a sample of digital technologies in science education and popularization of science in society. During the workshop we are planning to present:

1. Elements of modern science electronic applications to school physics textbooks (Electronic Application for Students and Lessons Constructor for Teachers)
2. Multimedia interactive models and scientific games based on authors original development – “Network environment for collective modeling”
 - DNA constructor
 - My First Collider
 - First Nanotechnologist
 - Memo + Knowledge
3. Samples of research labs in collective modeling environment (Physics, Biology)
4. Interactive model of electron microscope in the augmented reality environment
5. Multimedia interactive expositions for science education (Microcosm, Macrocosm, the Cosmic Calendar by Carl Sagan, Morphology of Plants)



HOW VIDEOS CAN BE USED IN E-LEARNING – A CASE STUDY

Sónia Seixas
soniabseixas@gmail.com

*Universidade Aberta, Rua Escola Politécnica, 147,
1269-001 Lisboa, Portugal
IMAR - Institute of Marine Research, CIC, University
of Coimbra, 3000 Coimbra, Portugal*

Abstract. For this case study video was used in the context of a course of Biological Classification and Evolution. This is a course that integrates within a 3-year Environmental Sciences degree (Bachelor). This degree is given by the Universidade Aberta (Open University of Portugal) in e-learning. The objectives of this course are essentially to study the biological classification as well as their evolution in temporal scale. Videos were used to explain evolution, illustrate the scheme of animals and their behaviour. To achieve this objective several links were used to free videos on the internet. Descriptions of certain behaviour are much easier to understand when viewing animals doing it compare with a text description. The visualization of videos by students is advice but not compulsory. Some of the student used it others no. From written evaluations was detected that the students that watch the videos have better results in identification of animals, principally if the photo is taken while an animal is moving. A small survey is done to evaluated how the students considering videos important to their learning.



Author Index

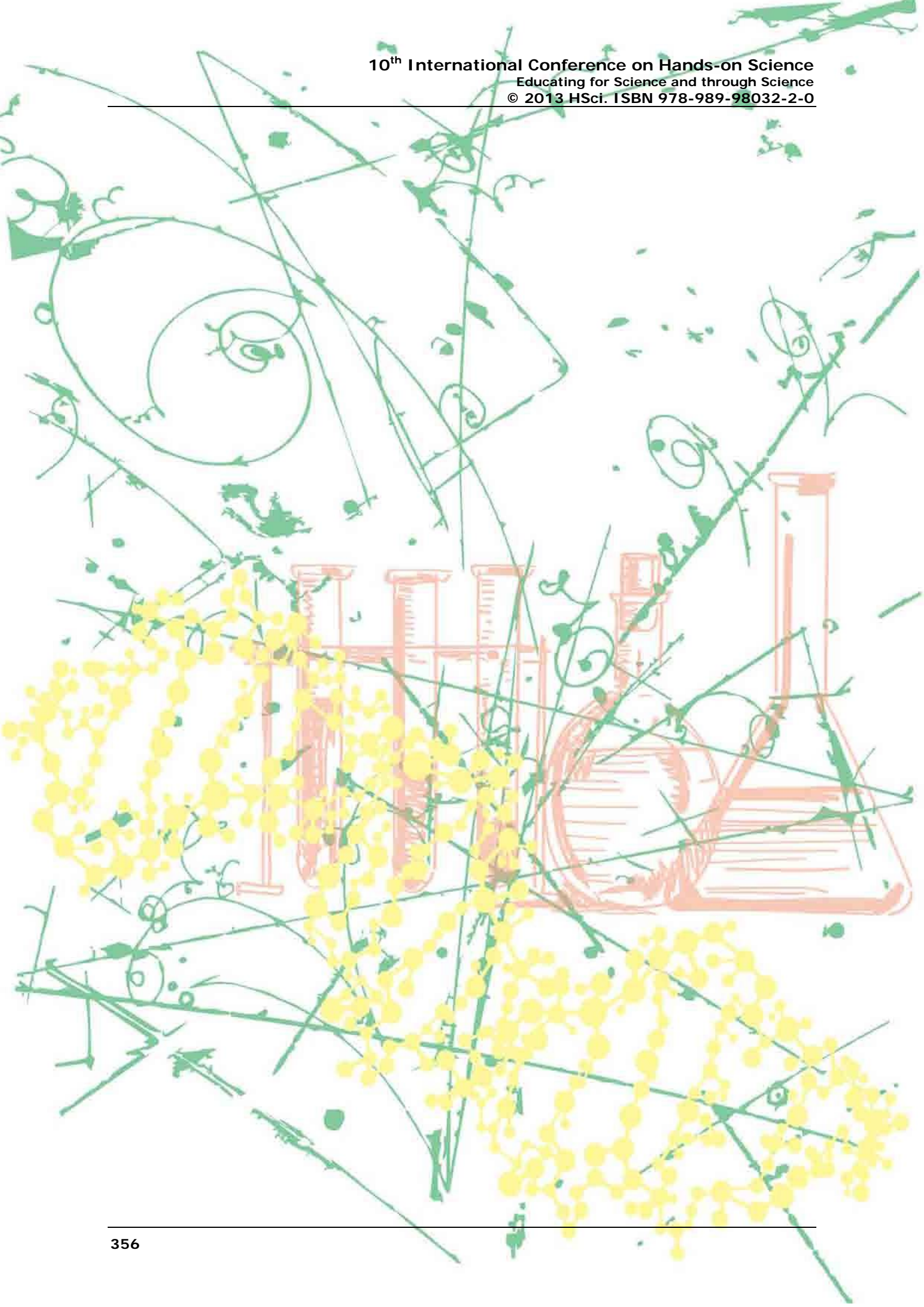

- Abreu, C. 115
Aghasi, E. 9
Almeida Aguiar, C. 214
Almeida, M. 149, 320
Almeida, MJ. 214
Almeida, MT. 214
Artemenkov, D. 351
Ba Tran, T. 290
Balalykin, S. 353
Balážovič, M. 144
Baník, I. 96
Bartoš, P. 181, 175
Bazovsky, MI. 41
Belaga, V. 351, 353
Beniačiková, M. 193
Berezovska I. 154, 352
Bisan, KM Battrawi. 210, 330
Bombara, M. 181, 175
Borges Seixas, S. 142
Camarinha, S. 126
Caglin Akillioglu, F. 141
Çalışkan, I. 319
Černý, J. 284
Chang, H. 213
Chang, W. 213
Cheng, Y. 213
Chicinas, LF. 142
Chien-Liang, Lin. 62
Chiu, Y. 102
Chou, CH. 79
Chovancová, M. 92, 96
Čížková, V. 136
Collazo, A. 110
Costa, MFM. 115, 121, 145, 149, 200, 321, 322
Crina, S. 49
Čtrnáctová, H. 27, 136
Czaja, M. 198
Darwish Kirresh, S. 221
Dirner, A. 181, 175, 353
Dogan, D. 320
Dorrío, BV. 110, 190
Drozd, Z. 215, 322
Ellermeijer, T. 3, 143, 290
Erdosne Toth, E. 318
Eroglu Dogan, E. 320
Esteves, Z. 145, 200
Falteisek, L. 235
Fančovičová, J. 267
Faria, C. 143
Featonby, D. 143, 323
Feng-Yi, Chen. 102
Ferlet, R. 15
Fernandes, M. 121
Fernández-Novell, JM. 164
Franko, F. 181, 175
Fu Yi, Shieh. 62, 276
Ganajová, M. 131, 136, 272
Gaspar, R. 143
Gintner, M. 181, 175
Golec-Biernat, K. 154
Golubeva, E. 353
Gomes, A. 214
Gomes, MT. 212
Grosu, I. 7
Guimarães, L. 321
Hajduk, R. 158, 188
Hanč, J. 229
Hanisko, P. 303
Haverlíková, V. 46
Hirça, N. 320
Hlaváčová, J. 181, 175
Holec, S. 83
Hollan, J. 263
Horváthová, M. 67
Houfková, J. 215, 322
Hruška, M. 83, 193
Hubeňáková, V. 36
Janštová, V. 235, 284
Jen-Chin, Lin. 62, 276
Ješková, Z. 67, 272, 290
Karawajczyk, B. 32, 198
Kazachkov, A. 17, 281
Kedzierska, E. 143, 290
Kelecsényi, P. 312
Kimáková, K. 136, 254, 272
Kireš, M. 17, 213, 272, 290
Kirresh, HS. 347
Klygina, K. 353
Komarova, A. 353
Köse, M. 320
Kotulakova, K. 298
Krišková, K. 193
Kristofová, M. 131
Kudrnová, T. 307
Kwiatkowski, M. 32, 198
Látal, F. 343
Lešková, A. 254, 267
Lomachenkov, I. 351
Lukáč, S. 338
Machado, P. 149
Malaquias, I. 211
Mandíková, D. 217, 322
Mário Almeida, A. 321, 322
Marques, M. 149
Matsyuk, O. 352
Melo, I. 10, 181, 175
Micescu, N. 142
Milěř, T. 263
Mošna, F. 162
Mourek, J. 323

- Muhtaseb, R. 330
Novak, P. 244
Nováková, M. 213
Noversa, S. 115
Novotný, J. 327
Oliveira, J. 211, 212
Ondera, J. 205
Onderová, L. 205
Orlínová, M. 106
Paiva, S. 214
Páleníková, M. 312
Panebrattsev, Y. 351, 353
Pavlendová, G. 96
Pedrosa de Jesus, J. 258
Pereira, R. 121
Pereira, S. 126
Pérez, C. 110
Petrláková, M. 27
Pinky, T. 284
Pociask-Bialy, M. 154
Polčín, D. 303
Potapova, A. 353
Potrebenikova, E. 353
Pucholt, Z. 343
Raganová, J. 83, 193
Reguli, J. 250
Rito, A. 322
Rodrigues dos Santos, R. 321
Rodríguez, S. 190
Rogério Gallo, P. 212
Sá Machado, MF. 149
Salinas Castellanos, A. 17
Santos, C. 143
Santos, TM. 258
Seixas, S. 353
Sekerák, J. 338
Semchukov, P. 353
Shoshin, A. 353
Sidorov, N. 353
Silva, C. 121
Siváková, M. 312
Slabeycius, J. 303
Šmejkal, P. 136
Smirnov, O. 353
Soares, C. 126
Solovyov, A. 352
Stebniki Tabora, W. 73
Stepanova, Y. 353
Stetsenko, M. 353
Šulcová, R. 307
Svandova, K. 144
Šveda, D. 36
Svobodová, J. 263, 327
Talavášková, B. 323
Taşcı, A. 9
Teixeira, CA. 212
Timková, V. 67
Tomášik, B. 144, 181, 175
Trna, J. 240, 244
Trnova, E. 240, 244
Uşak, M. 320
Vacek, V. 240
Varela, P. 115, 121
Vergara, R. 190
Vila-Chã, R. 322
Vladescu, E. 20
Vladescu, LC. 24
Vokal, S. 353
Vorontsova, N. 351, 353
Yang, MS. 79
Zámečnicková, V. 27
Zaragoza Domènech, C. 164
Zhumaev, V. 351
Zilavy, P. 87

The Organizers of the 10th International Conference on Hands-on Science acknowledge the sponsorship cooperation and support of these sponsorships and collaborations:



Universidade do Minho
Escola de Ciências

Universidade de Vigo



Pavol Jozef Šafárik University in Košice
Faculty of Science



PD COMP, distribútor produktov CMA



PMS Delta s.r.o.

Autorizovaný dovoz, predaj a poradenstvo Vernier



SLOVAK RESEARCH
AND DEVELOPMENT
AGENCY

LPP-0223-09 Science on Stage Slovakia

SLOVENSKÁ
SPORITELŇA



Občianske združenie
PRÍRODOVEDEC



KOŠICE2013
EUROPEAN CAPITAL OF CULTURE



SCIENCE in SCHOOL

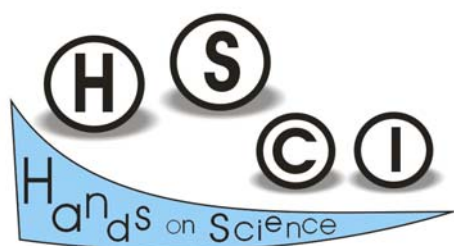

Education and Culture
Lifelong learning programme
COMENIUS